

CLYMER™
HONDA

GL1000 & 1100 FOURS • 1975-1983
SERVICE • REPAIR • MAINTENANCE



MARKETING AND
ACQUISITION
Lizanne
In Boston

Advertising & Promotion Consultant
Willy Maloney

Marketing Assistant
Liz Givens

Chief, In-Division
Business Systems

Assistant Art Director
Jennifer Jay

Sales Management
Dawn Seibert

Sales Management
Tom Maloney

Sales Management
Mia Tolson

Telephone Sales Support
Janet Casper

Telephone Sales Support
Karin Kay

Telephone Sales Support
Julie Givens

Customer Service/Account Manager
Cynthia Hart

Account Management/Assistant
Diana Jackson

Customer Service Representative
Lynn Brown

Customer Service Representative
Lynn Brown

Customer Service Representative
Lynn Brown

Customer Service Representative
Lynn Brown

Customer Service Representative
Lynn Brown

Customer Service Representative
Lynn Brown

Customer Service Representative
Lynn Brown

Customer Service Representative
Lynn Brown

Customer Service Representative
Lynn Brown

Customer Service Representative
Lynn Brown

Customer Service Representative
Lynn Brown

Customer Service Representative
Lynn Brown

Customer Service Representative
Lynn Brown

Customer Service Representative
Lynn Brown

Customer Service Representative
Lynn Brown

Chapter One
General Information 1

Chapter Two
Troubleshooting 2

Chapter Three
Periodic Lubrication and Maintenance 3

Chapter Four
Engine 4

Chapter Five
Clutch and Transmission 5

Chapter Six
Fuel and Exhaust Systems 6

Chapter Seven
Electrical System 7

Chapter Eight
Cooling System 8

Chapter Nine
Front Suspension and Steering 9

Chapter Ten
Rear Suspension and Final Drive 10

Chapter Eleven
Brakes 11

Chapter Twelve
Frame and Repainting 12

Chapter Thirteen
Sidecar Operation 13

Supplement
1980 and Later Service Information 14

Index 15

Wiring Diagrams 16

CONTENTS

QUICK REFERENCE DATA IX

CHAPTER ONE GENERAL INFORMATION 1

- | | |
|---------------------|------------------------|
| Manual organization | Expendable supplies |
| Service hints | Tools |
| Safety first | Serial numbers |
| Parts replacement | General specifications |

CHAPTER TWO TROUBLESHOOTING 9

- | | |
|---------------------------|----------------------------------|
| Operating requirements | Fuel system |
| Emergency troubleshooting | Clutch |
| Starter | Transmission |
| Charging system | Brakes |
| Engine | Lighting system |
| Engine noises | Front suspension
and steering |
| Excessive vibration | |
| Lubrication troubles | |

CHAPTER THREE PERIODIC LUBRICATION AND MAINTENANCE 17

- | | |
|----------------------|----------------|
| Routine checks | Engine tune-up |
| Periodic maintenance | Storage |

CHAPTER FOUR**ENGINE 42**

Engine removal	Rear cover
Engine disassembly/assembly	Final drive shaft
Clutch oil pump	Alternator rotor
Main oil pump	Alternator drive shaft
Camshaft belt replacement	Crankcase
Camshaft and rocker mechanism	Pistons and connecting rods
Cylinder heads	Piston rings
Valves and valve seats	Crankshaft
	Specifications

CHAPTER FIVE**CLUTCH AND TRANSMISSION 80**

Clutch	Transmission
--------	--------------

CHAPTER SIX**FUEL AND EXHAUST SYSTEMS 91**

Air cleaner	Fuel petcock
Carburetors	Exhaust system
Air cut valve	Specifications
Fuel pump	

CHAPTER SEVEN**ELECTRICAL SYSTEM 103**

Charging system	Condensers
Battery	Breaker points
Alternator	Starting system
Rectifier	Lighting system
Regulator	Horn
Ignition system	Fuses
Ignition coils	Wiring diagrams

CHAPTER EIGHT**COOLING SYSTEM 117**

Radiator	Hose replacement
Fan	Water pump
Thermostat	Temperature sender and fan control switch
Coolant change	

CHAPTER NINE**FRONT SUSPENSION AND STEERING 121**

Front wheel	Steering
Tire changing	Front forks

CHAPTER TEN		
REAR SUSPENSION AND FINAL DRIVE		138
Rear wheel	Drive shaft	
Rear shocks	Swing arm	
Final drive		
CHAPTER ELEVEN		
BRAKES		150
Front master cylinder	Rear master cylinder	
Front brake calipers	Rear brake caliper	
Front disc	Rear disc	
CHAPTER TWELVE		
FRAME AND REPAINTING		163
Kickstand (side stand)	Painting the frame	
Centerstand	Repainting	
Footpegs	Seat	
Stripping the frame		
CHAPTER THIRTEEN		
SIDECAR OPERATION		166
Installation	Wheels	
Preventive maintenance	Front suspension	
Tires	Rear suspension	
SUPPLEMENT		
1980 AND LATER SERVICE INFORMATION		174
INDEX		273
WIRING DIAGRAMS		276

QUICK REFERENCE DATA

TIMING MARKS

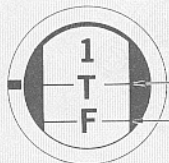

TDC (Cyl.
No. 1 & 2)

Timing
Mark (Cyl.
No. 1 & 2)

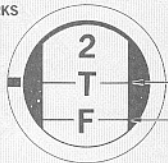

TDC (Cyl.
No. 3 & 4)

Timing
Mark (Cyl.
No. 3 & 4)

TUNE-UP SPECIFICATIONS

Valve clearance (cold)

1975-1979

Intake and exhaust

0.004 in. (0.10 mm)

1980-on

Intake

0.004 in. (0.10 mm)

Exhaust

0.005 in. (0.13 mm)

Spark plug type

Standard heat range

1975-1981

ND X24ES-U, NGK D8EA
or Champion A8-Y

ND X24EPR-U9 or NGK DPR8EA-9

1982-on

Cold weather

1975-1980

ND X24ES-U, NGK D8EA

1981

ND X27ESR-U or NGK DR9ES

1982-on

ND X22EPR-U9 or NGK DPR7EA-9

Extended high-speed riding

1975-1980

ND X22ES-U or NGK D7ES

1981

ND X22ESR-U or NGK DR7ES

1982-on

ND X27EPR-U or NGK DPR9EA-9

Spark plug gap

1975-1981

0.024-0.028 in. (0.6-0.7 mm)

1982-on

0.031-0.035 in. (0.8-0.9 mm)

Breaker point (1975-1979)

Gap

0.012-0.016 in. (0.3-0.4 mm)

Dwell

90 ± 2.5°

Ignition timing

1975-1977

Advance @ idle

5° BTDC @ 950 rpm

Maximum advance

37.5° BTDC @ 2,300-2,600 rpm

1978-1979

Advance @ idle

10° BTDC @ 950 rpm

Maximum advance

37.5° BTDC @ 2,300-2,600 rpm

1980-1981

Advance @ idle

13° BTDC @ 950 rpm

Maximum advance

38.5° starts @ 950 rpm

1982-on

Advance @ idle

10° BTDC @ 950 rpm

Maximum advance

38.5° starts @ 950 rpm

Idle speed

950 rpm

Firing order

1-3-2-4

**BREAKER POINTS
(1975-1979)**

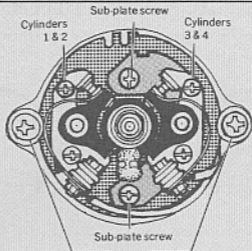

TORQUE SPECIFICATIONS

Item	ft.-lb.	mkg
Engine		
Engine oil drain bolt	25-29	3-4
Oil filter bolt	20-24	2.7-3.3
Cylinder head bolts		
6 mm	7-10	1.0-1.4
10 mm	37-40	5.3-5.7
Clutch bolts		
1975-1979	7-10	1.0-1.4
1980-on	7	1.0
Brakes		
Brake disc mounting nuts	20-24	2.7-3.3
Caliper mounting bolts		
Front		
1975-1979	22-29	3-4
1980-1981	13	1.8
1982	14-18	2.0-2.5
1983		
Upper	29	4.0
Lower	17	2.3
Rear		
1975-1979	40-43	5.5-6.0
1980-1981	13	1.8
1982-on	14-18	2.0-2.5
Caliper pivot bolt		
Front		
1982	19-22	2.5-3.0
1983	20	2.8
Rear (1982-on)	18-22	2.5-3.0
Suspension and final drive		
Front axle mounting nuts		
1975-1979	13-18	1.8-2.5
1980-on	25	3.5
Fork upper pinch bolt		
1975-1979	22-29	3.0-4.0
1980-on	16	2.2
Rear axle nut and bolt	58-72	8-10
Shock absorber nut and bolt	22-29	3.0-4.0
Final drive mounting nuts	25-33	3.5-4.5

NOTE: If you own a 1980 or later model, first check the Supplement at the back of the book for any new service information.

CHAPTER ONE

GENERAL INFORMATION

This book provides maintenance and repair information for the Honda GL-1000 and GL-1100 motorcycles as sold in the United States and United Kingdom. Chapters One through Fourteen contain general information on all models and specific information for 1975-1979 models. Specific information for 1980 and later models is in the supplement at the end of the book.

Read the following service hints to make the work as easy and pleasant as possible. Performing your own work can be an enjoyable and rewarding experience.

MANUAL ORGANIZATION

This chapter provides general information and specifications. See **Table 1** (found at the end of the chapter). It also discusses equipment and tools useful both for preventive maintenance and troubleshooting.

Chapter Two provides methods and suggestions for quick and accurate diagnosis and repair of problems. Troubleshooting procedures discuss typical symptoms and logical methods to pinpoint the trouble.

Chapter Three explains all periodic lubrication and routine maintenance necessary to keep your bike running well. Chapter Three also includes recommended tune-up procedures,

eliminating the need to constantly consult chapters on the various subassemblies.

Subsequent chapters describe specific systems such as the engine, transmission, and electrical system. Each chapter provides disassembly, repair, and assembly procedures in simple step-by-step form. If a repair is impractical for a home mechanic, it is so indicated. It is usually faster and less expensive to take such repairs to a dealer or competent repair shop. Specifications concerning a particular system are included at the end of the appropriate chapter.

Some of the procedures in this manual specify special tools. In all cases, the tool is illustrated either in actual use or alone. A well-equipped mechanic may find he can substitute similar tools already on hand or can fabricate his own.

The terms **NOTE**, **CAUTION**, and **WARNING** have specific meanings in this manual. A **NOTE** provides additional information to make a step or procedure easier or clearer. Disregarding a **NOTE** could cause inconvenience, but would not cause damage or personal injury.

A **CAUTION** emphasizes areas where equipment damage could result. Disregarding a **CAUTION** could cause permanent mechanical damage; however, personal injury is unlikely.

A **WARNING** emphasizes areas where personal injury or even death could result from

negligence. Mechanical damage may also occur. *WARNINGS are to be taken seriously.* In some cases serious injury or death has resulted from disregarding similar warnings.

Throughout this manual keep in mind two conventions. "Front" refers to front of the bike. The front of any component such as the engine is the end which faces toward the front of the bike. The left and right side refer to a person sitting on the bike facing forward. For example, the shift lever is on the left side. These rules are simple, but even experienced mechanics occasionally become disoriented.

SERVICE HINTS

Most of the service procedures covered are straightforward and can be performed by anyone reasonably handy with tools. It is suggested, however, that you consider your own capabilities carefully before attempting any operation involving major disassembly of the engine.

Some operations, for example, require the use of a press. It would be wiser to have these performed by a shop equipped for such work, rather than to try to do the job yourself with makeshift equipment. Other procedures require precision measurements. Unless you have the skills and equipment required, it would be better to have a qualified repair shop make the measurements for you.

Repairs go much faster and easier if your machine is clean before you begin work. There are special cleaners for washing the engine and related parts. Just brush or spray on the cleaning solution, let it stand, then rinse it away with a garden hose. Clean all oily or greasy parts with cleaning solvent as you remove them.

WARNING

Never use gasoline as a cleaning agent. It presents an extreme fire hazard. Be sure to work in a well-ventilated area when using cleaning solvent. Keep a fire extinguisher, rated for gasoline fires, handy in any case.

Special tools are required for some repair procedures. These may be purchased at a dealer (or borrowed if you are on good terms with the service department) or may be fabricated by a

mechanic or machinist, often at a considerable savings.

Much of the labor charge for repairs made by dealers is for the removal and disassembly of other parts to reach the defective unit. It is frequently possible to perform the preliminary operations yourself and then take the defective unit in to the dealer for repair at considerable savings.

Once you have decided to tackle the job yourself, read the entire section in this manual which pertains to it, making sure you have identified the proper one. Study the illustrations and text until you have a good idea of what is involved in completing the job satisfactorily. If special tools are required, make arrangements to get them before you start. It is frustrating and time-consuming to get partly into a job and then be unable to complete it.

Simple wiring checks can be easily made at home; but knowledge of electronics is almost a necessity for performing tests with complicated electronic testing gear.

During disassembly of parts keep a few general cautions in mind. Force is rarely needed to get things apart. If parts are a tight fit, like a bearing in a case, there is usually a tool designed to separate them. Never use a screwdriver to pry apart parts with machined surfaces such as crankcase halves and valve covers. You will mar the surfaces and end up with leaks.

Make diagrams wherever similar-appearing parts are found. For instance, case cover screws are often not the same length. You may think you can remember where everything came from — but mistakes are costly. There is also the possibility you may be sidetracked and not return to work for days or even weeks — in which interval carefully laid out parts may have become disturbed.

Tag all similar internal parts for location and mark all mating parts for position. Record number and thickness of any shims as they are removed. Small parts such as bolts can be identified by placing them in plastic sandwich bags. Seal and label the bags with masking tape.

Wiring should be tagged with masking tape and marked as each wire is removed. Again, do not rely on memory alone.

Disconnect battery ground cable before working near electrical connections and before disconnecting wires. Never run the engine with the battery disconnected; the alternator could be seriously damaged.

Protect finished surfaces from physical damage or corrosion. Keep gasoline and brake fluid off painted surfaces.

Frozen or very tight bolts and screws can often be loosened by soaking with penetrating oil, then sharply striking the bolt head a few times with a hammer and punch (or screwdriver for screws). Avoid heat unless absolutely necessary, since it may melt, warp or remove the temper from many parts.

Avoid flames or sparks when working near a charging battery or flammable liquids such as brake fluid or gasoline.

No parts, except those assembled with a press fit, require unusual force during assembly. If a part is hard to remove or install, find out why before proceeding.

Cover all openings after removing parts to keep dirt, small tools, etc., from falling in.

When assembling two parts, start all fasteners, then tighten evenly.

Clutch plates, wiring connections, and brake pads and discs should be kept clean and free of grease and oil.

When assembling parts, be sure all shims and washers are replaced exactly as they came out.

Whenever a rotating part butts against a stationary part, look for a shim or washer. Use new gaskets if there is any doubt about the condition of old ones. Generally you should apply gasket cement to one mating surface only so that the parts may be easily disassembled in the future. A thin coat of oil on gaskets helps them seal effectively.

Heavy grease can be used to hold small parts in place if they tend to fall out during assembly. However, keep grease and oil away from electrical components or brake pads and discs.

High spots may be sanded off a piston with sandpaper, but emery cloth and oil do a much more professional job.

Carburetors are best cleaned by disassembling them and soaking the parts in a commercial carburetor cleaner. Never soak gaskets and rubber parts in these cleaners. Never use wire to clean out jets and air passages; they are easily

damaged. Use compressed air to blow out the carburetor only if the float has been removed first.

A baby bottle makes a good measuring device for adding oil to forks and transmissions. Get one that is graduated in ounces and cubic centimeters.

Take your time and do the job right. Do not forget that a newly rebuilt motorcycle engine must be broken in the same as a new one. Keep rpm within the limits given in your owner's manual when you get back on the road.

SAFETY FIRST

Professional motorcycle mechanics can work for years and never sustain a serious injury. If you observe a few rules of common sense and safety, you can enjoy many safe hours servicing your own machine. You could hurt yourself or damage the bike if you ignore these rules.

1. Never use gasoline as a cleaning solvent.
2. Never smoke or use a torch in the vicinity of flammable liquids such as cleaning solvent in open containers.
3. Never smoke or use a torch in an area where batteries are being charged. Highly explosive hydrogen gas is formed during the charging process.
4. If welding or brazing is required on the machine, remove the fuel tank to a safe distance, at least 50 feet away. Welding on gas tanks requires special safety procedures and must be performed by someone skilled in the process.
5. Use the proper sized wrenches to avoid damage to nuts and injury to yourself.
6. When loosening a tight or stuck nut, guided by what would happen if the wrench should slip. Protect yourself accordingly.
7. Keep your work area clean and uncluttered.
8. Wear safety goggles during all operations involving drilling, grinding, or use of a cold chisel.
9. Never use worn tools.
10. Keep a fire extinguisher handy and be sure it is rated for gasoline and electrical fires.

PARTS REPLACEMENT

Honda makes frequent changes during a model year; some minor, some relatively major. When you order parts from the dealer or other parts distributor, always order by engine and chassis number. Write the numbers down and carry them in your wallet. Compare new parts to old before purchasing them. If they are not alike, have the parts manager explain the difference to you.

EXPENDABLE SUPPLIES

Certain expendable supplies are also required. These include grease, oil, gasket cement, wiping rags, cleaning solvent, and distilled water. Ask your dealer for the special locking compounds, silicone lubricants, and commercial chain lube products which make motorcycle maintenance simpler and easier. Solvent is available at most service stations and distilled water for the battery is available at most supermarkets.

TOOLS

For proper servicing, you will need an assortment of ordinary handtools. As a minimum, these include:

1. Metric combination wrenches
2. Metric sockets
3. Plastic mallet
4. Small hammer
5. Snap ring pliers
6. Gas pliers
7. Phillips screwdrivers
8. Slot (common) screwdrivers
9. Feeler gauges
10. Spark plug gauge
11. Spark plug wrench
12. Dial indicator

Engine tune-up and troubleshooting procedures require a few more tools, described in the following sections.

Hydrometer

This instrument measures state of charge of the battery, and tells much about battery condition. Such an instrument is available at any

auto parts store and through most larger mail order outlets. See Figure 1.

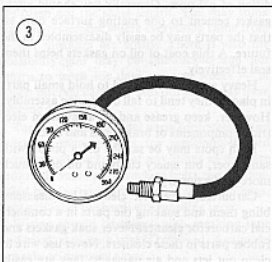
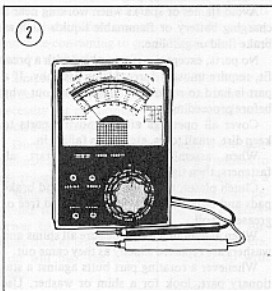
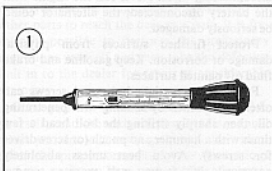

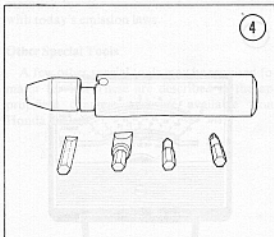

4

Multimeter or VOM

This instrument (Figure 2) is invaluable for electrical system troubleshooting and service. A few of its functions may be duplicated by locally fabricated substitutes, but for the serious hobbyist, it is a must. Its uses are described in the applicable sections of this book. Multimeters are available at electronics hobbyist stores and mail order outlets.

Compression Gauge

An engine with low compression cannot be properly tuned and will not develop full power. A compression gauge measures engine compression. The one shown in Figure 3 has a flexible stem which enables it to reach cylinders where there is little clearance between the cylinder head and frame. This is not necessary on the GL-1000. Inexpensive ones are available at auto accessory stores or by mail order from large catalog order firms.

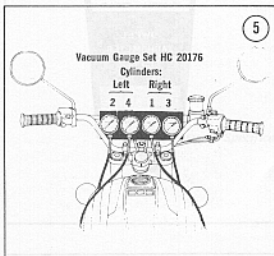

5

Impact Driver

This tool might have been designed with the motorcyclist in mind. It makes removal of engine cover screws easy and eliminates damaged screw slots. Good one are available at larger hardware stores. See Figure 4.

Carburetor Gauge Set

A gauge set which can display manifold vacuum for all four cylinders simultaneously will greatly simplify carburetor synchronization. Figure 5 shows the Honda gauge set. Less expensive versions are available.

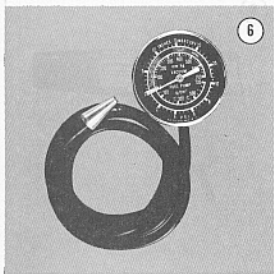

6

Fuel Pressure Gauge

This instrument is invaluable for evaluating fuel pump performance. Fuel system troubleshooting procedures in Chapter Two use a fuel pressure gauge. Usually a vacuum gauge and fuel pressure gauge are combined. See Figure 6.

Dwell Meter

A dwell meter measures the distance in degrees of cam rotation that the breaker points remain closed while the engine is running. Since this angle is determined by breaker point gap,

dwell angle is an accurate indication of breaker point gap.

Many tachometers intended for tuning and testing incorporate a dwell meter as well. See **Figure 7**. Follow the manufacturer's instructions to measure dwell.

Tachometer

A tachometer is necessary for tuning. Ignition timing and carburetor adjustments must be performed at the specified idle speed. The best instrument for this purpose is one with a low range of 0-1,000 or 0-2,000 rpm for setting idle, and a high range of 0-4,000 or more for setting ignition timing at 3,000 rpm. Extended range (0-6,000 or 0-8,000) instruments lack accuracy at lower speeds. The instrument should be capable of detecting changes of 25 rpm on the low range.

Strobe Timing Light

This instrument is necessary for tuning. It permits very accurate ignition timing. By flashing a light at the precise instant cylinder No. 1 fires, the position of the flywheel at that instant can be seen. Marks on the flywheel are lined up with the transmission case mark while the engine is running.

Suitable lights range from inexpensive neon bulb types to powerful xenon strobe lights. See **Figure 8**. Neon timing lights are difficult to see and must be used in dimly lit areas. Xenon strobe timing lights can be used outside in bright sunlight. Both types work on this motorcycle; use according to the manufacturer's instructions.

Exhaust Gas Analyzer

Of all instruments described here, this is the least likely to be owned by an owner/mechanic. One instrument samples the exhaust gases from the tailpipe and measures the thermal conductivity of the exhaust gas. Since different gases conduct heat at varying rates, thermal conductivity of the exhaust is a good indication of gases present.

This instrument is vital for accurately checking the effectiveness of exhaust emission control adjustments. Analyzers are relatively expensive to buy, but must be considered

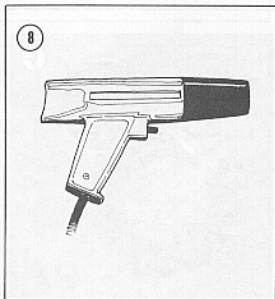
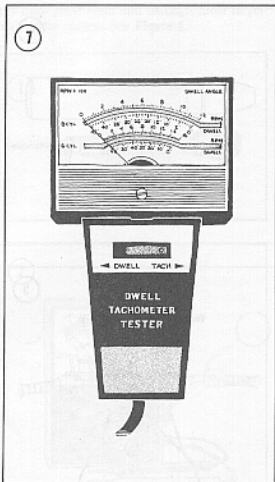

essential for the owner/mechanic to comply with today's emission laws.

Other Special Tools

A few other special tools may be required for major service. These are described in the appropriate chapters and are available from Honda dealers.

SERIAL NUMBERS

You must know the model serial number for registration purposes and when ordering special parts.

The frame serial number is stamped on the right side of the steering head. The engine serial number is stamped on top of the right crankcase half.

Table 1, General Specifications, is found on the next page.

OPERATING REQUIREMENTS

An operator needs to be responsible, sober, and well-rested at the right time. If you neglect the machine, the engine won't run. Use the right type of fuel, the right kind of oil, the right kind of

Table 1 GENERAL SPECIFICATIONS

Engine type	4-stroke, SOHC, horizontally opposed 4-cylinder
Displacement	61 cubic inches (999cc)
Compression ratio	9.2:1
Carburetion	4 Keihin constant vacuum carburetors
Ignition	Battery and coil
Firing order	1-3-2-4
Lubrication	Wet sump, filter and pump
Clutch	Wet, multi-plate
Transmission (5-speed constant mesh)	
1st	2.500
2nd	1.708
3rd	1.333
4th	1.097
5th	0.939
Final drive ratio	3.400
Starting system	Electric and manual kick
Wheelbase	60.6 in. (1,540mm)
Steering head angle	28° from vertical
Trail	4.7 in. (120mm)
Front suspension travel	5.1 in. (129.5mm)
Rear suspension travel	3.6 in. (91mm) travel
Front tire	3.50H19 (4PR)
Rear tire	4.50H17A (4PR)
Ground clearance	
1975-1977	5.7 in. (144.8mm)
1978-1979	5.5 in. (140mm)
Seat height	31.6 in. (803mm)
Overall height	
1975-1977	46.7 in. (1,185mm)
1978-1979	49.8 in. (1,265mm)
Overall width	
1975-1977	34.4 in. (875mm)
1978-1979	36.2 in. (920mm)
Overall length	
1975-1976	90.0 in. (2,285mm)
1978-1979	91.3 in. (2,320mm)
Fuel capacity	5 U.S. gallons (19 liters)
Dry weight	
1975-1977	584 lb. (265 kg)
1978-1979	601 lb. (273 kg)
Wet weight	
1975-1977	616 lb. (279 kg)
1978-1979	633 lb. (287 kg)

CHAPTER TWO

TROUBLESHOOTING

Diagnosing mechanical problems is relatively simple if you use orderly procedures and keep a few basic principles in mind.

The troubleshooting procedures in this chapter analyze typical symptoms, and show logical methods of isolating causes. These are not the only methods. There may be several ways to solve a problem, but only a systematic, methodical approach can guarantee success.

Never assume anything. Do not overlook the obvious. If you are riding along and the bike suddenly quits, check the easiest, most accessible problem spots first. Is there gasoline in the tank? Is the gas petcock in the ON or RESERVE position? Has a spark plug wire fallen off? Check ignition switch. Sometimes the weight of keys on a key ring may turn the ignition off suddenly.

If nothing obvious turns up in a cursory check, look a little further. Learning to recognize and describe symptoms will make repairs easier for you or a mechanic at the shop. Describe problems accurately and fully. Saying that "it won't run" isn't the same as saying "it quit on the highway at high speed and wouldn't start," or that "it sat in my garage for 3 months and then wouldn't start."

Gather as many symptoms together as possible to aid in diagnosis. Note whether the engine lost power gradually or all at once, what color

smoke (if any) came from the exhaust, and so on. Remember that the more complicated a machine is, the easier it is to troubleshoot because symptoms point to specific problems.

After the symptoms are defined, areas which could cause the problems are tested and analyzed. Guessing at the cause of a problem may provide the solution, but it can easily lead to frustration, wasted time, and a series of expensive, unnecessary parts replacements.

You do not need fancy equipment or complicated test gear to determine whether repairs can be attempted at home. A few simple checks could save a large repair bill and time lost while the bike sits in a dealer's service department. On the other hand, be realistic and do not attempt repairs beyond your abilities. Service departments tend to charge heavily for putting together a disassembled engine that may have been abused. Some won't even take on such a job — so use common sense; don't get in over your head.

OPERATING REQUIREMENTS

An engine needs three basics to run properly: correct gas/air mixture, compression, and a spark at the right time. If one or more are missing, the engine won't run. The electrical system is the weakest link of the three. More problems

result from electrical breakdowns than from any other source. Keep that in mind before you begin tampering with carburetor adjustments and the like.

If a bike has been sitting for any length of time and refuses to start, check the battery for a charged condition first, and then look to the gasoline delivery system. This includes the tank, fuel pump, fuel petcock, lines, and the carburetors. Rust may have formed in the tank, obstructing fuel flow. Gasoline deposits may have gummed up carburetor jets and air passages. Gasoline tends to lose its potency after standing for long periods. Condensation may contaminate it with water. Drain old gas and try starting with a fresh tankful.

TROUBLESHOOTING INSTRUMENTS

Chapter One lists many of the instruments needed and detailed instructions on their use.

EMERGENCY TROUBLESHOOTING

When the bike is difficult to start or won't start at all, it does not help to grind away at the starter or kick the tires. Check for obvious problems even before getting out your tools. Go down the following list step-by-step. Do each one; you may be embarrassed to find your kill switch off, but that is better than wearing your battery down with the starter. If the bike still will not start, refer to the appropriate troubleshooting procedures which follow in this chapter.

1. Is there fuel in the tank? Do not trust the fuel gauge. Remove the filler cap and rock the bike; listen for fuel sloshing around.

WARNING

Do not use an open flame to check in the tank. A serious explosion is certain to result.

2. Is the fuel petcock ON? Turn it to RESERVE to be sure that you get the last remaining gas.
3. Is the kill switch ON?
4. Is the choke in the right position — pulled out for a cold engine and pushed in for a warm engine?

5. Is battery dead? Check it with a hydrometer.
6. Has the main fuse (Figure 1) blown? Replace it with a good one.
7. Is the transmission in NEUTRAL or the clutch lever pulled in? The GL-1000 will not start in gear without pulling in the clutch.

STARTER

Starter system troubles are relatively easy to isolate. The following are common symptoms and cures. Figure 2 shows a wiring diagram of the starting system. Use it to help isolate troubles.

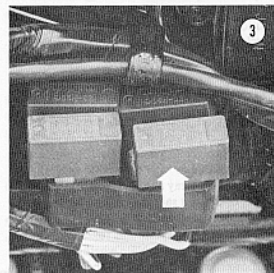
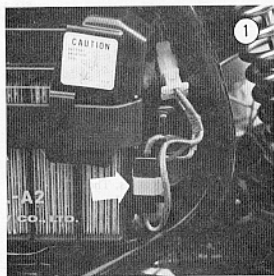

1. **Engine cranks very slowly or not at all** — If the headlight is very dim or not lighting at all, most likely the battery or its connecting wires are at fault. Check, if necessary, battery using the procedures described in Chapter Seven. Check the wiring for breaks, shorts, and dirty connections.

If the battery and connecting wires check good, the trouble may be in the starter, solenoid, or wiring. To isolate the trouble, short the 2 large solenoid terminals together (not to ground); if the starter cranks normally, check the starter solenoid wiring as described under symptoms 2 and 3. If the starter still fails to crank properly, remove starter and test it.

2. **Starter only operates when clutch lever is pulled in, even in neutral** — If neutral light comes on normally, the diode shown in Figure 3 is open; temporarily replace it with one of the other 3 diodes to test it. If neutral light comes on when clutch lever is pulled in, the diode is shorted; a shorted diode will not prevent the starter from operating.

NOTE: Leave defective diodes out until they can be replaced. That way you can still operate the bike.

If neutral light does not come on in neutral, but engine starts when clutch lever is pulled in, the neutral switch is defective or the connecting wire is open.

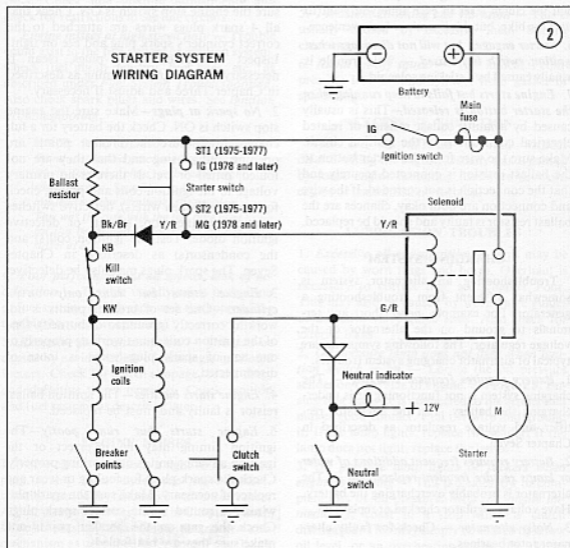

3. *Starter operates while transmission is in gear without pulling in the clutch lever* — The neutral switch or connecting wire is shorted to ground.

4. *Starter will not operate while transmission is in gear with the clutch lever pulled in* — The clutch lever switch or connecting wire is shorted to ground.

5. *Starter runs without pushing starter button* — This is caused by the diode shown in Figure 4 shorting. Remove the diode. If you do not have a replacement handy, leave it out. The engine may be difficult to start since the function of this diode is to bypass the ballast resistor for starting. In an emergency, you could substitute the diode shown in Figure 3; you will have to pull the clutch lever in each time you want to start the bike, but this is a minor inconvenience.

6. *Starter engages, but will not disengage when ignition switch is released* — This trouble is usually caused by a sticking solenoid.

7. *Engine starts but fails to keep running when the starter button is released*—This is usually caused by a faulty ballast resistor or related electrical connections in the ignition circuit. Make sure the wire from the starter button to the ballast resistor is connected securely and that the connection is not corroded. If the wire and connection are both okay, chances are the ballast resistor is faulty and should be replaced.

CHARGING SYSTEM

Troubleshooting an alternator system is somewhat different from troubleshooting a generator. For example, *never* short any terminals to ground on the alternator or the voltage regulator. The following symptoms are typical of alternator charging system troubles.

1. *Battery requires frequent charging* — The charging system is not functioning or is undercharging the battery. Test the alternator rectifier and voltage regulator as described in Chapter Seven.

2. *Battery requires frequent additions of water or lamps require frequent replacement* — The alternator is probably overcharging the battery. Have voltage regulator checked or replace it.

3. *Noisy alternator* — Check for faulty alternator rotor bearings.

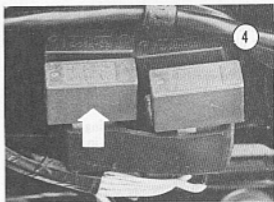

IGNITION SYSTEM

1. *Engine cranks but will not start*—Make sure the engine stop switch is ON. Check that all 4 spark plug wires are attached to the correct cylinder's spark plug and are on tight. Inspect for fouled spark plugs, clean if necessary. Check ignition timing as described in Chapter Three and adjust if necessary.

2. *No spark at plugs*—Make sure the engine stop switch is ON. Check the battery for a full charge. Make sure the breaker points are opening and closing and that they are not fouled, pitted or wet. If there is no primary voltage to the ignition coils and points, check for loose or broken wire(s), defective switches (ignition, engine stop, starter) or defective ignition diode. Test the ignition coil(s) and the condenser(s) as described in Chapter Seven. The spark plugs may also be defective.

3. *Engine starts but runs only on 2 cylinders*—One set of breaker points is not working correctly (grounded or burned). One of the ignition coils is not working properly or one set of spark plug wires is loose or disconnected.

4. *Engine starts but dies*—The ignition ballast resistor is faulty and must be replaced.

5. *Engine starts but runs poorly*—The ignition timing may be incorrect or the ignition advance unit is not working properly. Check the spark plugs for fouling or wear and replace if necessary. Make sure the spark plug wires are routed to the correct spark plugs. Check the gap on the breaker points and make sure they are not fouled.

ENGINE

These procedures assume the starter cranks the engine over normally. If not, refer to *Starter* section in this chapter.

Poor Performance

1. *Engine misses erratically at all speeds* — Intermittent trouble like this can be difficult to find. The fault could be in the ignition system, exhaust system (exhaust restriction), or fuel system. Follow troubleshooting procedures for these systems carefully to isolate the trouble.
2. *Engine misses at idle only* — Trouble could exist anywhere in ignition system. Follow *Ignition Troubleshooting* procedure carefully. Trouble could exist in the carburetor idle circuits. Check idle mixture adjustments and check for restrictions in the idle circuits.
3. *Engine misses at high speed only* — Trouble could exist in the fuel system or ignition system. Check fuel pump delivery, fuel lines, etc., as described under *Fuel System Troubleshooting*. Also check spark plugs and wires. See *Ignition Troubleshooting*.

NOTE: Many GL-1000 owners have found that leaded gasolines (regular and ethyl) foul the plugs and cause high speed missing. Switching to lead-free or low lead regular eliminates the problem. This was the case with the test bike used for this book, and performance did not suffer at all.

4. *Poor performance at all speeds, lack of acceleration* — Trouble usually exists in ignition or fuel system. Check each with the appropriate troubleshooting procedure.
5. *Excessive fuel consumption* — This can be caused by a wide variety of seemingly unrelated factors. Check for clutch slippage, brake drag, and defective wheel bearings. Check ignition and fuel systems as described later.

ENGINE NOISES

1. *Valve clatter* — This is a light to heavy tapping sound from under the valve covers. Usually caused by excessive valve clearance. Adjust clearance as described in Chapter Three. If noise persists, disassemble the rocker arm mechanism as described in Chapter Four. Look

for broken springs, worn rocker arms, and worn shafts.

2. *Knocking or pinging during acceleration* — This is caused by using a lower octane fuel than recommended. It may also be caused by poor fuel available at some "discount" gasoline stations. Pinging can also be caused by incorrect ignition timing or spark plugs of the wrong heat range. See Chapter Three.
3. *Slapping or rattling noises at low speed or during acceleration* — This may be caused by piston slap, i.e., excessive piston-cylinder wall clearance.
4. *Knocking or rapping while decelerating* — This is usually caused by excessive rod bearing clearance.
5. *Persistent knocking and vibration* — This is usually caused by excessive main bearing clearance.
6. *Rapid on-off squeal* — This indicates compression leak around cylinder head gasket or spark plugs.

EXCESSIVE VIBRATION

This can be difficult to find without disassembling the engine. Usually this is caused by loose engine mounting hardware or worn engine or transmission bearings.

LUBRICATION TROUBLES

1. *Excessive oil consumption* — This may be caused by worn rings and bores. Overhaul is necessary to correct this; see Chapter Four. This may also be caused by worn valve guides or defective valve guide seals. Also check for exterior leaks.
2. *Oil pressure lamp does not light when ignition switch is on* — Locate the oil pressure sender on right side of engine. See Figure 5. Ensure that the wire is connected to the sender and makes good contact. Pull off wire and ground it. If the lamp lights, replace the sender. If the lamp does not light, replace the lamp.
3. *Oil pressure lamp lights or flickers when engine is running* — This indicates low or complete loss of oil pressure. *Stop the engine immediately*; coast to a stop with the clutch disengaged. This may simply be caused by a low oil level, or an overheating engine. Check the

oil level and coolant temperature. Check for a shorted oil pressure sender with an ohmmeter or other continuity tester. Listen for unusual noises indicating bad bearings, etc. Do not restart the engine until you know why the light went on and the problem has been corrected.

FUEL SYSTEM

Fuel system troubles must be isolated to the carburetor, fuel pump, or fuel lines. These procedures assume the ignition system has been checked and properly adjusted.

1. **Engine will not start** — First determine that fuel is being delivered to carburetor. Disconnect fuel pump outlet line at air box. Insert line in small container to catch fuel, and operate starter briefly. Fuel should pour from line. If not, check system from tank to fuel pump. See Chapter Six. If fuel pump delivers fuel, disconnect fuel lines one at a time between air box and each carburetor.

2. **Rough idle or engine miss with frequent stalling** — Check carburetor adjustments. See Chapter Three.

3. **Stumbling when accelerating from idle** — Check the idle speed adjustment and for sticking carburetor pistons. See Chapter Three.

4. **Engine misses at high speed or lacks power** — This indicates possible fuel starvation. Check fuel pump pressure and capacity. Clean main jets and float needle valves.

5. **Black exhaust smoke** — Black exhaust smoke means a badly overrich mixture. Check that manual choke disengages. Check idle mixture and idle speed. Check for excessive fuel pump pressure, leaky floats, or worn float needle valves. Also check that jets are proper size. Compare with specifications in Chapter Six.

Fuel Pump Pressure Testing

1. Install a T-fitting in the fuel line close to the air box. See Figure 6.
2. Connect a fuel pressure gauge to the fitting with a short tube.
3. Run the engine at 5,000 rpm; fuel pressure should be about 1.5 psi (0.18 kg/cm²) with the float needle valve closed. If pressure varies appreciably, replace the pump.
4. Stop the engine. Pressure should drop off very slowly. If pressure drops rapidly, the outlet valve is leaky.



Fuel Pump Capacity Testing

1. Disconnect the fuel line near the air box. See Figure 6.
2. Fit a rubber hose over the fuel line so fuel can be directed into a graduated container with about one quart capacity.
3. Start engine and run at idle for 30 seconds. There is sufficient fuel in the float chambers for this.
4. Stop the engine. The fuel pump should have delivered about $\frac{1}{2}$ - $\frac{1}{2}$ pint (150-200cc) fuel or more in 30 seconds.

CLUTCH

All clutch troubles except adjustments require partial engine disassembly to identify and cure the problem. See Chapter Five for procedures.

1. **Slippage** — This is most noticeable when accelerating in a high gear at relatively low speed. To check slippage, shift to 2nd gear and release the clutch as if riding off. If the clutch is good, the engine will slow and stall. If the clutch slips, continued engine speed will give it away.

Slippage results from insufficient clutch lever free play, worn discs or pressure plate, or weak springs.

2. **Drag or failure to release** — This trouble usually causes difficult shifting and gear clash, especially when downshifting. The cause may be excessive clutch lever free play, warped or bent pressure plate or clutch disc, broken or loose linings, or lack of lubrication in clutch actuating mechanism.

3. **Chatter or grabbing** — A number of things can cause this trouble. Check tightness of engine mounting bolts. Check for worn or misaligned pressure plate. Also check lever free play.

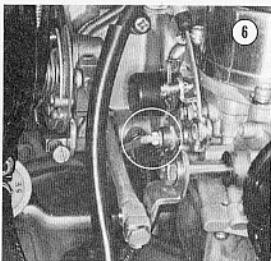

TRANSMISSION

Transmission problems are usually indicated by one or more of the following symptoms:

- a. Difficulty shifting gears
- b. Gear clash when downshifting
- c. Slipping out of gear
- d. Excessive noise in neutral
- e. Excessive noise in gear

Transmission symptoms are sometimes hard to distinguish from clutch symptoms. Be sure that the clutch is not causing the trouble before working on the transmission.

BRAKES

1. *Brake lever or pedal goes all the way to its stop* — There are numerous causes for this including excessively worn pads, air in the hydraulic system, leaky brake lines, leaky calipers, or leaky or worn master cylinder. Check for leaks and thin brake pads. Bleed the brakes. If this does not cure the trouble, rebuild the calipers and/or master cylinder.
2. *Spongy lever or pedal* — Normally caused by air in the system; bleed the brakes.
3. *Dragging brakes* — Check for swollen rubber parts, due to improper brake fluid or contamination, and obstructed master cylinder bypass port. Clean or replace defective parts.
4. *Hard lever or pedal* — Check brake pads for contamination. Also check for restricted brake lines and hoses.
5. *High speed fade* — Check for contaminated brake pads. Ensure that recommended brake fluid is installed. Drain entire system and refill if in doubt.

6. *Pulsating lever or pedal* — Check for excessive brake disc runout. Undetected accident damage is also a frequent cause of this.

LIGHTING SYSTEM

Bulbs which continuously burn out may be caused by excessive vibration, loose connections that permit sudden current surges, poor battery connections, or installation of the wrong type bulb.

A majority of light and horn or other electrical accessory problems are caused by loose or corroded ground connections. Check those first, and then substitute known good units for easier troubleshooting.

Reserve Lighting System (1975-1977 only)

The reserve lighting system prevents complete loss of headlights or taillights in the event of bulb failure in either. It also indicates to the rider that a failure has occurred. However, there is no safeguard against the *reserve lighting unit* failing and causing complete loss of headlight or taillights.

If you are prepared and know what to do, you can bypass the reserve lighting unit temporarily to restore your lights, then replace the unit when you can. You need 3 small jumper wires made up with female quick-disconnect connectors or 3 jumpers with alligator clips.

CAUTION

If you use alligator clips, make sure that they cannot short together or to any other metal nearby.

If your reserve lighting unit fails, disconnect both plugs from the unit. See Figure 7. Install 3 jumpers to the connectors. Figure 8 shows schematically where these jumpers are connected. If a filament burns out also, you will not have any back-up lighting, but of course, this is the case with any bike without a reserve lighting unit.

If you want to permanently remove the reserve lighting system from the bike, make up 2 female plugs with the appropriate jumpers permanently wired in. Remove the reserve lighting unit from the bike and plug the harness plugs into the jumpered connectors.

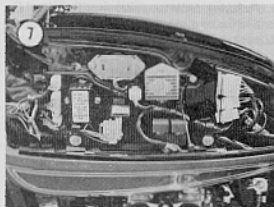

FRONT SUSPENSION AND STEERING

1. *Too stiff or too soft* — Make sure forks have not been leaking and oil is correct viscosity. If in doubt, drain and refill as described in Chapter Three.
2. *Leakage around seals* — There should be a light film of oil on fork tubes. However, large amounts of oil on tubes means the seals are leaking. Replace seals. See Chapter Nine.
3. *Fork action is rough* — Check for bent tube.
4. *Steering wobbles* — Check for correct steering head bearing tightness. See Chapter Nine.

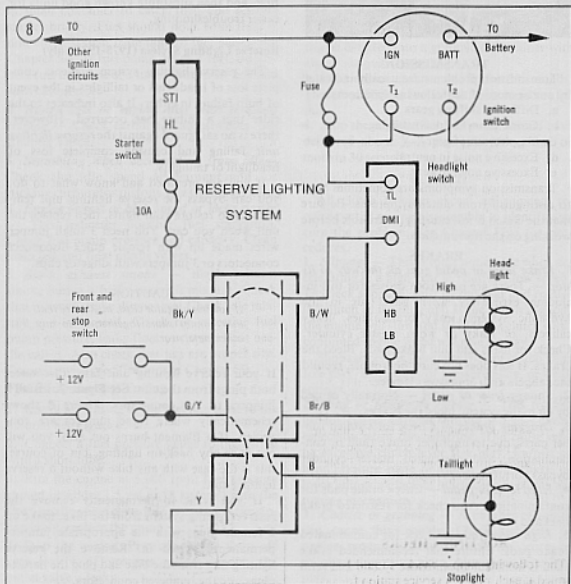

NOTE: If you own a 1980 or later model, first check the Supplement at the back of the book for any new service information.

CHAPTER THREE

3

PERIODIC LUBRICATION AND MAINTENANCE

A motorcycle, even in normal use, is subjected to tremendous heat, stress, and vibration. When neglected, any bike becomes unreliable and actually dangerous to ride. When properly maintained, the Honda GL-1000 is one of the most reliable bikes available and will give many miles and years of reliable, fast, and safe riding.

Service intervals for all GL-1000's are based on 3,750 miles (6,000 km). Previously, service intervals were based on 6,000 miles for 1975-1977 models, and 7,200 miles for 1978 models. Now all owners should use the new intervals.

This chapter describes all periodic maintenance required to keep your bike running properly. Routine checks are easily performed at each fuel stop. Other periodic maintenance appears in order of frequency. The engine tune-up is treated separately as the various procedures interact and must be done together. Table 1 summarizes all periodic maintenance required in an easy-to-use form.

ROUTINE CHECKS

The following simple checks should be performed at each stop at a service station for gas.

Engine Oil Level

Place motorcycle on centerstand and check oil level through inspection window. See Figure 1. Maintain level between upper and lower marks. Use lubricant recommended in Table 2.

NOTE: On 1976 and later models, there is a small window wiper to clean the glass. If oil residue obscures the window, rotate the small screw in the window.

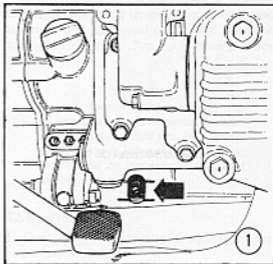

Table 1 MAINTENANCE SUMMARY

Every fuel stop

- Check engine oil level
- Check tire pressure
- Check battery electrolyte level
- Check coolant level

Every 3,750 miles (6,000 km)

- Drain crankcase breather (1978-on)
- Clutch adjustment
- Check tires
- Check brake fluid level
- Inspect brake pads
- Clean air filter
- Clean spark plugs
- Inspect breaker points
- Check ignition timing
- Check carburetor idle speed

Every 7,500 miles (12,000 km)

- Check throttle operation
- Inspect fuel lines
- Inspect brake lines
- Check the side stand rubber
- Change engine oil and filter
- Inspect cooling system
- Inspect wheel hubs, rims and spokes
- Lubricate final drive
- Check front suspension
- Check rear suspension
- Tighten nuts, bolts and other fasteners
- Replace air filter
- Adjust valve clearance
- Check compression
- Replace spark plugs
- Check carburetor synchronization

Every 22,500 miles (36,000 km)

- Change coolant
- Change fuel filter
- Change brake fluid
- Change front fork oil
- Change final drive oil

Table 2 RECOMMENDED LUBRICANTS, FLUIDS AND CAPACITIES

	Temperature	Type	Capacity
Engine	All	SAE 10W-40, SE	
	Above 59°F (15°C)	SAE 30, SE	3.7 U.S. quarts;
	32-59°F (0-15°C)	SAE 20 or 20W, SE	3.2 Imp. quarts;
	Below 32°F (0°C)	SAE 10W	3.5 liters
Final drive oil	Above 41°F (5°C)	SAE 90 (GL-5)	6.8-7.5 U.S. ounces;
	Below 41°F (5°C)	SAE 80 (GL-5)	3.6-6.2 Imp. ounces; 200-220cc
Fork oil	All	Automatic transmission fluid	5.8-6.1 U.S. ounces; 4.8-5.1 Imp. ounces; 170-180cc
Drive shaft	All	Extreme Pressure (EP) grease	—
Coolant	See Table 4	Ethylene glycol for aluminum engines	3.4 U.S. quarts; 2.9 Imp. quarts; 3.2 liters
Fuel	All	B5 (pump)	Total: 5 U.S. gallons;
		91 (Research) octane	4.3 Imp. gallons; 19 liters
			Reserve: 0.8 U.S. gallons; 0.7 Imp. gallons; 3 liters
Brake fluid	All	DOT 3, J1703	

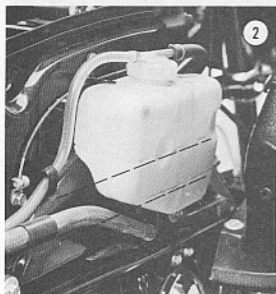

Coolant Level

Check coolant level when engine has warmed to normal operating temperature. Swing down the right pod cover and check level in reserve tank. See Figure 2. Top up if level is below FULL.

WARNING

Do not remove radiator pressure cap when engine is hot. The coolant is under pressure and can scald you. In addition, since the cap is below the reserve tank, coolant will be lost even from a cold engine.

General Inspection

1. Quickly examine engine for signs of oil, fuel or coolant leakage.

2. Check tires for imbedded stones. Pry them out with the ignition key.
3. Make sure all lights work.

NOTE: *At least check the stoplight. It can burn out anytime. Motorists cannot stop as quickly as you and need all the warning you can give.*

4. Check final drive housing for signs of oil leakage. Check oil level as described under *Preventive Maintenance, Final Drive Oil Level*, if there is any leakage.

Tire Pressure

Tire pressure must be checked with tires cold. Correct tire pressure depends on load. See **Table 3**.

Many tire pressure gauges will not reach the GL-1000 valve stems. Two that will fit are shown in **Figure 3**.

Battery

Remove left side cover and check battery electrolyte level. The level must be between the upper and lower level marks on the case. Top up with *distilled water*.

Check less frequently than recommended here if experience indicates level does not change much. Check most frequently in hot weather.

PERIODIC MAINTENANCE

The following procedures are arranged according to frequency. **Table 1** summarizes these procedures.

Engine tune-up procedures, all of which must be done every 7,500 miles, are properly called preventive maintenance. However, they should be done together, so they are treated together under *Engine Tune-up*.

3,750 Mile (6,000 km) Service

Crankcase Breather (1978 and Later)

All GL-1000's manufactured since January 1, 1978 are equipped with a crankcase breather system. Crankcase vapors are directed into the air cleaner assembly where they mix with incoming air and eventually are burned in the normal combustion process. Vapors which con-

Table 3 TIRE PRESSURES

	Front psi (kg/cm ²)	Rear psi (kg/cm ²)
Under 200 lb. load	28 (2.0)	32 (2.3)
Over 200 lb. load	28 (2.0)	40 (2.8)

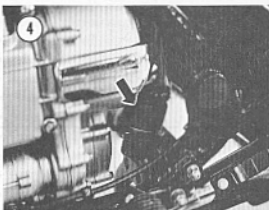
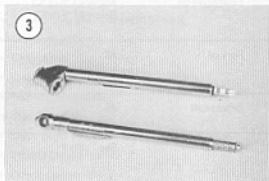

dense out are stored in a container which must be emptied every 3,750 miles (6,000 km).

To empty the container:

1. Disconnect the hose from the storage container. See Figure 4.

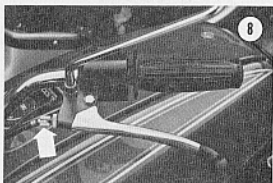
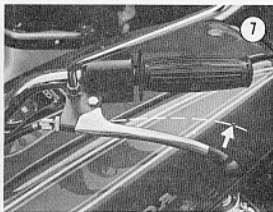
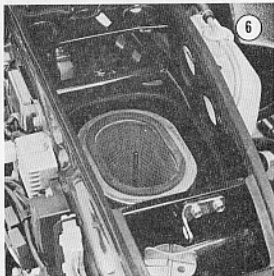

2. Remove the mounting bolt securing the container, and remove the container.
3. Pull the flow restrictor out of the container, and pour the contents of the container out.
4. Insert the flow restrictor, and install the storage container on the bike.

Air Filter Cleaning

1. Open top compartment and remove tool tray.
2. Unscrew the air cleaner wing nut(s) and remove the cover. See Figure 5.
3. Lift out the air cleaner element (Figure 6).
4. Tap the element lightly to loosen dust. Blow remaining dust out from the inside with compressed air.

CAUTION

Do not blow dust from the outside of the element inward. This would clog the element and make it useless.

5. Install the element by reversing these steps.

Clutch Adjustment

In order for the clutch to fully engage and disengage, there must be $\frac{1}{4}$ - $\frac{3}{4}$ in. (5-15mm) free play at the lever end. See Figure 7.

1. Loosen locknut and screw cable adjuster all the way into clutch lever bracket. See Figure 8.
2. Loosen locknut and turn lower cable adjuster clockwise as viewed from top to loosen clutch cable. See Figure 9.

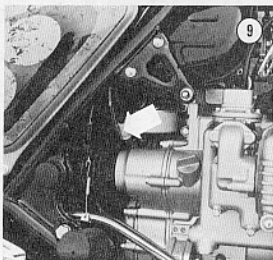

- Remove clutch cover. See **Figure 10**.
- Loosen locknut and turn adjuster clockwise until there is a slight resistance. See **Figure 11**. From this point, turn adjuster $\frac{1}{4}$ turn counterclockwise and tighten locknut.
- Rotate lower cable adjuster (**Figure 9**) counterclockwise until there is about $\frac{1}{4}$ in. free play at lever end. Tighten locknut.
- Unscrew lever and cable adjuster (**Figure 8**) to set free play between $\frac{1}{4}$ and $\frac{5}{8}$ in. Tighten locknut.
- Road test to make sure that clutch fully disengages when lever is pulled in; if it does not, the bike will creep in gear when stopped. Also make sure clutch fully engages; if it does not, clutch will slip, particularly when accelerating in a high gear.

Tires

Check tread for excessive wear, deep cuts, imbedded objects such as stones, glass, nails, etc. If you find a nail in a tire, mark its location with a light crayon or chalk before pulling it out. This will help locate the hole in the inner tube.

Check local traffic regulations concerning minimum tread depth. Measure with a tread depth gauge or small rule. See **Figure 12**. Honda recommends replacement when front tread depth is $\frac{1}{16}$ in. (1.5mm) or less and rear tread depth is $\frac{1}{2}$ in. (2mm) or less. New front

tread depth is 0.27 in. (7mm); new rear tread depth is 0.35 in. (9mm). Tread wear indicators appear across the tire when tread reaches minimum safe depth. Replace the tire at this point.

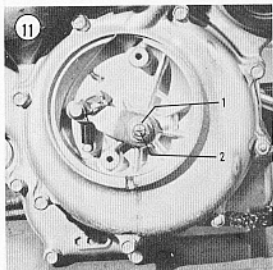

1. Locknut
2. Adjuster

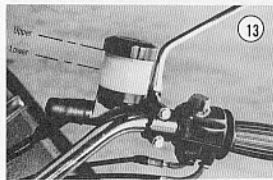
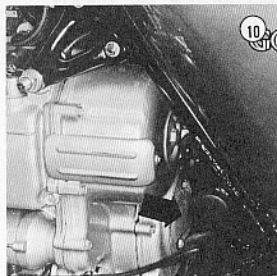
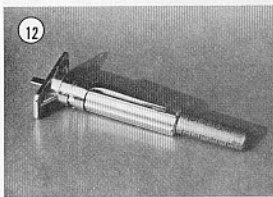

Brake Fluid Level

Check the level in both the front and rear reservoirs. Maintain the level between the upper and lower marks on the reservoir. See Figures 13 and 14.

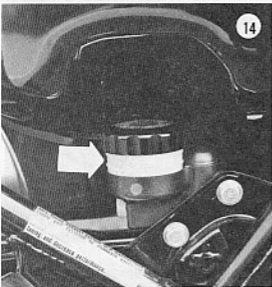

WARNING

Use brake fluid clearly marked DOT 3 and/or SAE J1703 only. Others may vaporize and cause brake failure.

Brake Pad Inspection

Brake pad wear depends on a number of factors including riding conditions and rider habits. If most of your riding is in mountainous areas, stop-and-go traffic, or if you know you are heavy on the brakes, check them more frequently than recommended here.

To check the pads, remove the inspection window on the caliper and look inside. Replace all front pads as a set if any pad is worn to the red line on the pad. See Figure 15. Replace both rear pads if either red marker reaches the red zone. See Figure 16.

7,500 Mile (12,000 km) Service

Engine Oil and Filter Change

Periodic oil changes will contribute more to engine longevity than any other single factor.

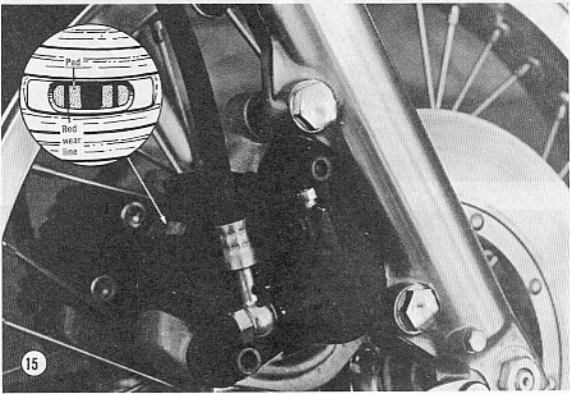

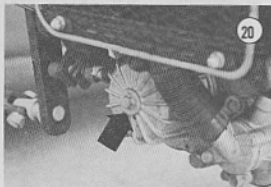
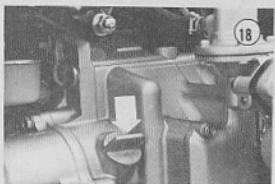
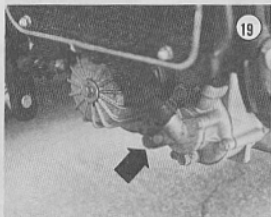
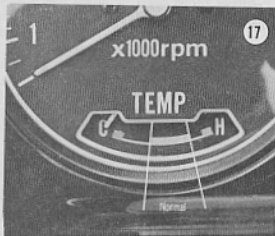
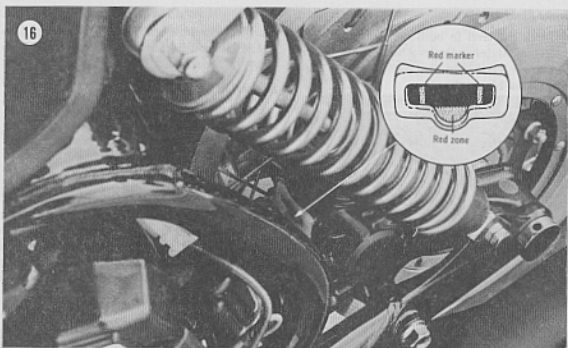

Change oil every 7,500 miles; more often in dusty areas. In fact, many Honda mechanics think that 3,000 mile intervals are safer.

1. Warm engine to its normal operating range. See **Figure 17**.
2. Rest bike on centerstand.
3. Remove oil filler cap. See **Figure 18**.
4. Place container with at least 4-quart capacity under crankcase.
5. Remove oil drain plug (**Figure 19**) with a 17mm wrench.

WARNING

Get your hand out of the way as soon as plug is ready to come out. Hot oil drains very rapidly and could cause painful burns.

6. Remove oil filter bolt, cover, and filter. See **Figure 20**. Use a 12mm wrench.

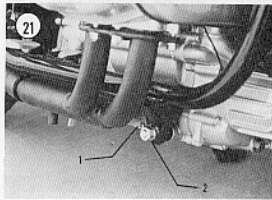

1. Oil screen cover

2. Engine mounting nut

7. Let oil drain for at least 10 minutes. Operate kickstarter several times to drain oil caught in the engine.

CAUTION

Do not permit engine to start as the engine will be damaged.

8. Make sure washer on drain plug is in good condition to prevent leaks and install the plug. Tighten to 25-29 ft.-lb. (3.5-4.0 mkg).
9. Clean inside of filter cover and filter bolt in solvent.
10. Remove 4 screws securing oil screen cover. Remove engine mounting nut. See **Figure 21**. Flex frame outward with large drift or pry bar just enough to remove screen. Clean screen thoroughly in solvent.
11. Install oil screen. Make sure O-ring and cover gasket are in good condition. Secure cover.
12. Install new filter and O-ring in cover. See **Figure 22** for correct order of all parts. Install cover on bike. Make sure that alignment tabs are correct as shown in **Figure 23**. Tighten bolt to 20-24 ft.-lb. (2.7-3.3 mkg).
13. Pour waste oil into empty bleach bottle or similar sealable container and dispose of it properly.
14. Fill the crankcase through the oil filler with about 3.7 U.S. quarts (3.5 liters) of oil. See **Table 2** for recommended types.

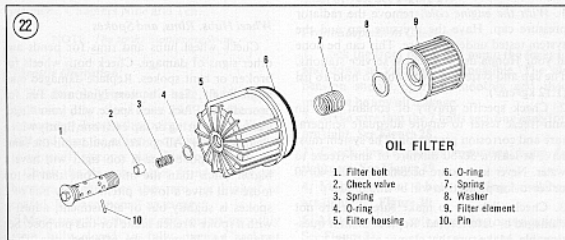

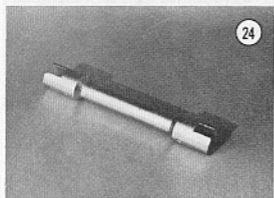
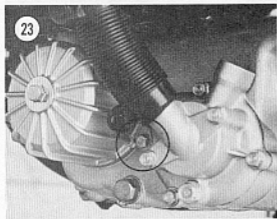

15. Run engine slowly to circulate oil. Stop engine and check level in inspection window with bike on centerstand.

16. Check carefully for leaks around filter cover and drain plug.

Cooling System Inspection

1. *With the engine cold*, remove the radiator pressure cap. Have the pressure cap and the system tested under pressure. This can be done at your Honda dealer or most service stations. The cap and system must be able to hold 16 psi (1.12 kg/cm²).

2. Check specific gravity of coolant with an anti-freeze tester to ensure adequate temperature and corrosion protection. The system must have at least a 50/50 mixture of anti-freeze to water. Never let mixture become less than 40/60 or corrosion protection will be impaired.

3. Check all hoses to make sure they are not damaged or deteriorated. Replace them if questionable. Make sure that clamps are tight.

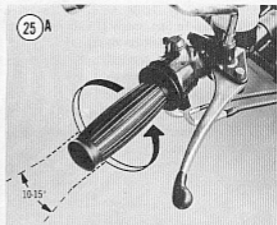

4. Clean the front of the radiator. Remove dirt and bugs which limit air flow through the radiator.

Wheel Hubs, Rims, and Spokes

Check wheel hubs and rims for bends and other signs of damage. Check both wheels for broken or bent spokes. Replace damaged ones immediately. See Chapters Nine and Ten for procedures. Pluck each spoke with your finger like a guitar string or tap each one lightly with a small hammer. All spokes should emit the same sound. A spoke that is too tight will have a higher pitch than the others; one that is too loose will have a lower pitch. If only one of 2 spokes is slightly out of adjustment, adjust it with a spoke wrench made for this purpose. See Figure 24. If more are affected, the wheel

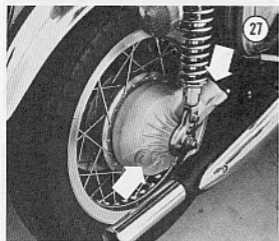

should be removed and trued. See *Spoke Adjustment*, Chapters Nine and Ten.

NOTE: The spoke nipples are 9mm.

Throttle Operation

The throttle grip should have 10-15 degrees rotational play. See **Figure 25A**. If adjustment is necessary, loosen the locknut shown in **Figure 25B** and turn the adjuster one way or the other to achieve the proper play. Tighten the locknut.

Check the throttle cables from grip to carburetors. Make sure they are not kinked or chafed. Replace them if necessary.

Make sure that throttle grip rotates smoothly from fully closed to fully open. Check at

center, full left, and full right positions of the steering.

Fuel Lines

Check fuel lines between fuel pump, tank, and carburetors. Replace any which are chafed, cracked, swollen on the ends, or damp from fuel.

Brake Lines

Check brake lines between master cylinders and brake calipers. If there is any leakage, tighten the connections and bleed the brakes as described in Chapter Eleven. If this does not cure the leak, or if a line is obviously damaged, cracked, or chafed, replace the line and bleed the brake.

Side Stand Rubber

The rubber tip on the side stand kicks the stand up if you should forget. If it wears down to the molded line (**Figure 26**), replace the rubber as it can no longer be effective.

Final Drive Lubrication

Check the oil level in the final drive. Rest the bike on the centerstand on level ground. Remove the cap (**Figure 27**). The level should just reach the bottom of the hole. Top up if necessary with a lubricant recommended in **Table 2**.

At the same interval, inject a small amount of grease into the Zerk fitting on 1976 and later final drives. See **Figure 27**.

Front Suspension Check

1. Lock the front brake and pump the forks up and down as vigorously as possible. The suspension should operate smoothly and there must not be any oil leakage.
2. Make sure that the 2 bolts securing each fork are tight. See **Figure 28**.
3. Check brake caliper mounting bolts for tightness. See **Figure 29**.
4. Make sure that 4 bolts securing handlebars are tight. See **Figure 30**.
5. Make sure that axle mounting nuts are tight. See **Figure 31**.

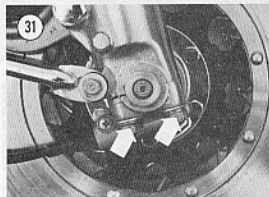
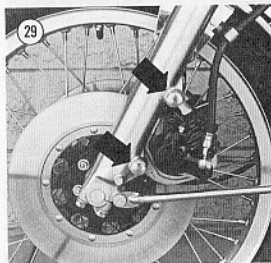
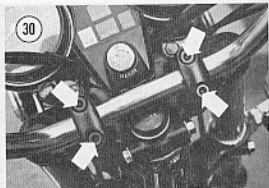
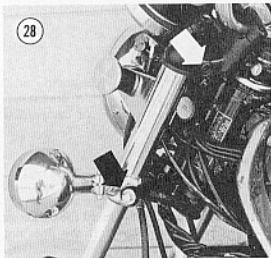

CAUTION

If any are loose, loosen them all and retorque as described in Chapter Nine, Front Wheel Installation, Steps 5-10.

Rear Suspension Check

1. Rest bike on centerstand. Push hard against the side of the wheel to check for play in the swing arm bushing.
2. Make sure that rear shock mounting hardware is tight.
3. Make sure that rear brake caliper mounting bolts are tight.

4. Make sure that cotter on axle nut is secure and in good condition. See Figure 32.

Nuts, Bolts, and Other Fasteners

Constant vibration can loosen many fasteners on a motorcycle. Check the tightness of *all* fasteners, especially those on:

- a. Engine mounts
- b. Engine covers
- c. Handlebars

Table 4 COOLANT MIXTURE

Temperature	Anti-freeze to Water Ratio	Amount of Anti-freeze
Above -30°F (-35°C)	50/50	1.7 U.S. qt.; 1.4 Imp. qt.; 1.6 liters
Below -30°F (-35°C)	60/40	2.0 U.S. qt.; 1.7 Imp. qt.; 1.9 liters

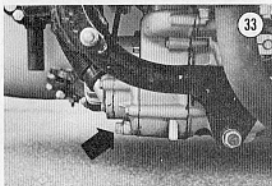

- d. Gearshift lever
- e. Exhaust system
- f. Lighting equipment

Air Cleaner Replacement

To replace the element, follow the procedure described under *7,500 Mile (12,000 km) Service, Air Filter Cleaning*.

22,500 Mile (36,000km) Service

Changing Coolant

The coolant should be completely drained and refilled with at least a 50/50 mixture of ethylene glycol anti-freeze and distilled water at intervals given in **Table 1**.

WARNING

Antifreeze is a toxic waste. Drain into suitable containers and dispose of it according to local regulations. Do not store coolant where it is accessible to children or pets.

CAUTION

Use only ethylene glycol specifically labeled for aluminum engines.

In areas where freezing temperatures occur, add a higher percentage of anti-freeze to protect the system to temperatures far below those likely to occur. **Table 4** lists recommended

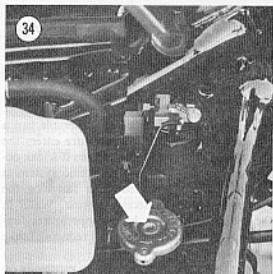

amounts of anti-freeze to protect the GL-1000 at various temperatures.

The following procedure must be performed when the engine is cool.

1. Remove reserve tank from bracket and pour anti-freeze out through the filler opening. Do not disconnect hoses.

CAUTION

Anti-freeze can damage painted surfaces and plants. If you spill any anti-freeze, flush the area immediately with clean water.

2. Place a pan with at least a gallon capacity under the water pump.
3. Remove the drain plug from the water pump. See **Figure 33**.
4. Remove the radiator cap. See **Figure 34**.
5. Let the coolant drain fully, then install the drain plug.
6. Fill the radiator through the radiator filler (not the reservoir filler).
7. Run the engine at idle speed to remove air from the system. Add additional coolant to radiator if level drops.

8. Install radiator cap tightly.
9. Fill the reserve tank to the FULL mark.

Changing Fuel Filter

The fuel filter, located near the front of the tank (Figure 35), removes dirt, rust, and other foreign matter from the fuel before it reaches the engine. Eventually, accumulation of impurities clogs the filter and restricts fuel flow. To prevent this, replace filter at the interval specified in Table 1.

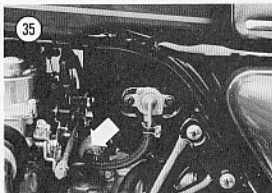

Changing Brake Fluid

Every time you remove the reservoir cap a small amount of dirt and moisture enters the brake fluid. The same thing occurs if a leak occurs, or any part of the hydraulic system is loosened or disconnected. Dirt can clog the system and cause unnecessary wear. Water in the fluid vaporizes at high temperatures, impairing the hydraulic action and reducing brake performance.

To maintain peak performance, especially on a bike as heavy as the GL-1000, change the brake fluid at intervals given in Table 1.

1. Remove dust cap from one front caliper bleeder valve (Figure 36) and connect a small hose. Place free end of hose in a container.
2. Open the bleeder valve with wrench about $\frac{1}{2}$ turn.
3. Squeeze the brake lever several times to force out as much brake fluid as possible. Close the bleeder valve.
4. Repeat Steps 1-3 for the other front caliper.
5. Repeat the procedure for the rear brake.

WARNING

Do not reuse brake fluid which has been drained from a brake system.

6. Fill the front reservoir with new brake fluid, install the cap, and bleed the system as described under *Brake Bleeding*.

WARNING

Use brake fluid clearly marked DOT 3 and/or SAE J1703 only. Others may vaporize and cause brake failure.

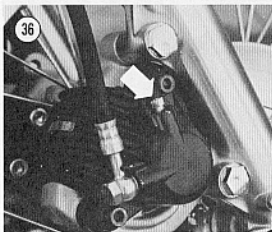

7. Fill the rear reservoir with new brake fluid and bleed the system as described under *Brake Bleeding*.

Brake Bleeding

This procedure is not necessary unless the brakes feel spongy, there has been a leak in the system, or the fluid has been replaced as described in the procedure above. This procedure is much easier with an assistant.

1. Remove the dust cap from the brake caliper bleeder valve (Figure 36) and connect a small hose. On front system, start with either caliper.
2. Place the free end of the hose in a clean glass container such as a soft drink bottle. Fill the container with enough fresh brake fluid to keep the end submerged.
3. Fill the reservoir with fresh brake fluid and screw the cap on loosely to prevent entry of dirt.

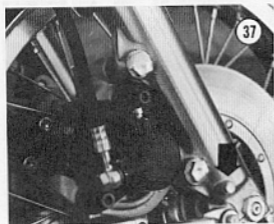
**WARNING**

Use brake fluid clearly marked DOT 3 and/or SAE J1703 only. Others may vaporize and cause brake failure.

4. Pump the front brake lever several times with the bleeder valve closed until you feel pressure building up.
5. Hold the lever down tight and open the bleeder valve about $\frac{1}{2}$ turn. Squeeze the lever (or pedal) all the way down.
6. Hold the lever down and close the bleeder valve completely.
7. Watch the fluid which emerges from the bleeder hose. Repeat Steps 4-6 until fluid completely free of air bubbles emerges from hose.

NOTE: Do not allow the reservoir to empty during the bleeding or more air will enter the system. If this occurs, the entire procedure must be repeated.

8. Remove the bleeder hose, make sure the bleeder valve is tight, and install the bleeder valve dust cap.
9. Repeat entire procedure on the other front brake caliper.
10. Hold the lever (or pedal) down tightly and check the brake line connections for leaks.
11. Top reservoir up to UPPER level and install the reservoir cap tightly.

Changing Front Fork Oil

1. Rest bike on centerstand.
2. Place a large container such as an oil drain pan under each front fork drain plug. See **Figure 37**.
3. Unscrew both front fork drain plugs.
4. Pump the forks several times with the drain plugs removed to expel oil.
5. Install drain plugs securely.
6. Place a jack under the engine crankcase to support the bike with the forks extended. Use a piece of wood between the jack and the engine to prevent damage to the engine.
7. Remove the filler plug caps (**Figure 38**) and remove the filler plugs with an Allen wrench. See **Figure 39**.
8. Pour 5.8-6.1 oz. (170-180cc) premium quality automatic transmission fluid into each fork.

9. Install and tighten the filler plugs and install the caps.
10. Remove jack.

Changing Final Drive Oil

1. Ride the bike for 5-10 miles to warm the final drive oil. Warm oil drains much more quickly and thoroughly than cold oil.
2. Place container under drain hole in final drive case. See **Figure 40**.
3. Remove filler plug. See **Figure 41**.
4. Remove drain plug and allow oil to drain. When the flow stops, rotate the rear wheel several times by hand to drain any oil trapped in recesses in the case.
5. When all oil is drained, install the drain plug. Ensure that sealing washer is in good condition.
6. Fill final drive case with lubricant recommended in **Table 2**. Fill until level just reaches the bottom of the filler hole. This will require about 6.8-7.5 ounces (200-220cc).
7. Install filler cap securely.

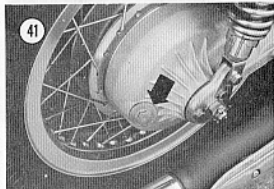
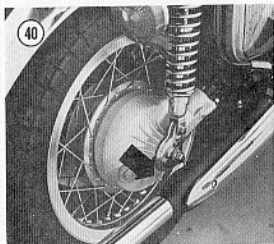

ENGINE TUNE-UP

Engine tune-up consists of several accurate and careful adjustments to obtain maximum engine performance. Since different systems in an engine interact to affect overall performance, tune-up must be accomplished in the following order:

1. Valve clearance adjustment
2. Ignition adjustment and timing
3. Carburetor adjustment

Some of these procedures are done every 3,750 miles (6,000 km), others are done every 7,500 miles (12,000 km). See **Table 1**.

Valve Clearance Adjustment

This is a series of simple mechanical adjustments which are performed while the engine is *cold*. Valve clearance for your engine must be adjusted carefully. If the clearance is too small, the valves may be burned or distorted. Large clearance results in excessive noise. In either case, engine power is reduced.

1. Remove timing mark cover. See **Figure 42**.

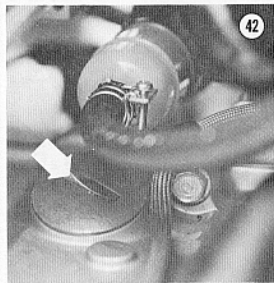

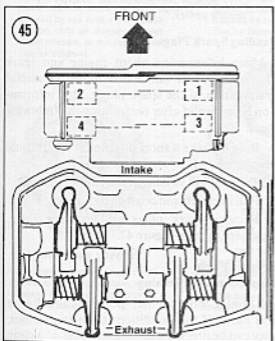
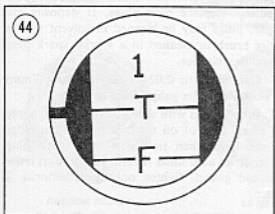
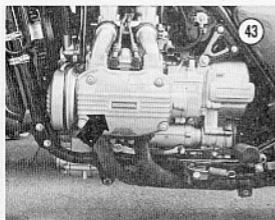

Table 5 VALVE ADJUSTMENT SEQUENCE

Cylinder Number	Intake Valve	Exhaust Valve
1	A	A
2	B	B
3	B	A
4	A	B

A = Adjust with cylinder 1 at TDC of compression stroke.
B = Adjust with cylinder 1 at TDC of exhaust stroke.

- Remove both valve covers. See Figure 43.
- Rotate the crankshaft with the alternator rotor shaft or the kickstarter until the T-1 mark aligns with the timing index on the crankcase. See Figure 44.

4. Wiggle the tappets for cylinder No. 1 with your fingers. See Figure 45. If both intake and exhaust rockers move, cylinder No. 1 is at TDC of its compression stroke; proceed to the next step. If only the intake rocker wiggles, cylinder No. 1 is on its exhaust stroke; rotate the crankshaft exactly 360° to bring cylinder No. 1 to TDC of its compression stroke.

5. Insert a 0.004 in. (0.1mm) feeler gauge between the valve stem and the rocker of each of the valves indicated by "A" in Table 5. A slight drag as the gauge is inserted indicates correct clearance.

6. If clearance is not correct, loosen the locknut and turn the adjusting screw in this position and tighten the locknut. Recheck the clearance to make sure that it has not changed.

7. Rotate the crankshaft exactly 360° and again align the T-1 mark with the timing index on the case. Use the kickstarter or rotate the alternator rotor shaft clockwise with a wrench.

8. Check and adjust valves indicated by "B" in Table 5 in the same manner as described in Steps 5 and 6.

9. Install valve covers and timing mark cover.

Compression Test

Every 7,500 miles, check cylinder compression. Record the results and compare them at the next check. A running record will show trends in deterioration so that corrective action can be taken before complete failure.

Many automotive books describe a "dry" compression test and a "wet" compression test. Usually these tests must be interpreted together to isolate the trouble in cylinders or valves. Unfortunately, the wet test is not always conclusive with a horizontal engine.

Dry Test

1. Warm the engine to normal operating temperature. Ensure that the choke valve and throttle valve are completely open.
2. Remove the spark plugs.
3. Connect the compression tester to one cylinder following manufacturer's instructions.
4. Have an assistant crank the engine over until there is no further rise in pressure.
5. Remove the tester and record the reading.
6. Repeat Steps 3-5 for each cylinder.

When interpreting the results, actual readings are not as important as the difference between readings. All readings should be from about 170 psi (12 kg/cm²). Readings below 140 psi (10 kg/cm²) indicate that an engine overhaul is due. A maximum difference of 15 psi (1.0 kg/cm²) between any 2 cylinders is acceptable. Greater differences indicate worn or broken rings, leaky or sticky valves, or a combination of all. Compare with vacuum gauge reading to isolate the trouble more closely.

Spark Plug Cleaning/Replacement

1. Grasp the spark plug leads as near to the plug as possible and pull them off the plugs.
2. Blow away any dirt which has accumulated in the spark plug wells.

CAUTION

The dirt could fall into the cylinders when the plugs are removed, causing serious engine damage.

3. Remove the spark plugs with spark plug wrench.

NOTE: If plugs are difficult to remove, apply penetrating oil around base of plugs and let it soak in about 10-20 minutes.

4. Inspect spark plugs carefully. Look for plugs with broken center porcelain, excessively

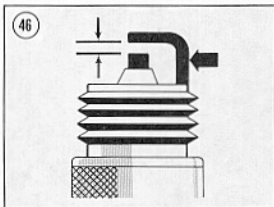

eroded electrodes, and excessive carbon or oil fouling. Replace such plugs. If deposits are light, plugs may be cleaned in solvent with a wire brush or cleaned in a special spark plug sandblast cleaner.

5. Gap plugs to 0.024-0.028 in. (0.6-0.7mm) with a wire feeler gauge. See Figure 46.
6. Install plugs with a new gasket. First, apply a small drop of oil to threads. Tighten plugs finger-tight, then tighten with a spark plug wrench an additional 1/4 turn. If you must reuse an old gasket, tighten only an additional 1/4 turn.

NOTE: Do not overtighten. This will only squash the gasket and destroy its sealing ability.

Reading Spark Plugs

Much information about engine and spark plug performance can be determined by careful examination of the spark plugs. This information is only valid after performing the following steps.

1. Ride the bike a short distance at full throttle in any gear.
2. Turn off kill switch before closing throttle.
3. Pull in clutch and coast to a stop.
4. Remove spark plugs and examine them. Compare them to Figure 47.

Breaker Point Inspection and Cleaning

Through normal use, points gradually pit and burn. If this condition is not too serious, they can be dressed with a few strokes of a clean

47

SPARK PLUG CONDITION

**NORMAL**

- Identified by light tan or gray deposits on the firing tip.
- Can be cleaned.

**GAP BRIDGED**

- Identified by deposit buildup closing gap between electrodes.
- Caused by oil or carbon fouling. If deposits are not excessive, the plug can be cleaned.

**OIL FOULED**

- Identified by wet black deposits on the insulator shell bore and electrodes.
- Caused by excessive oil entering combustion chamber through worn rings and pistons, excessive clearance between valve guides and stems, or worn or loose bearings. Can be cleaned, if engine is not repaired, use a hotter plug.

**CARBON FOULED**

- Identified by black, dry fluffy carbon deposits on insulator tips, exposed shell surfaces and electrodes.
- Caused by too cold a plug, weak ignition, dirty air cleaner, too rich a fuel mixture, or excessive idling. Can be cleaned.

**LEAD FOULED**

- Identified by dark gray, black, yellow, or tan deposits or a fused glazed coating on the insulator tip.
- Caused by highly leaded gasoline. Can be cleaned.

**WORN**

- Identified by severely eroded or worn electrodes.
- Caused by normal wear. Should be replaced.

**FUSED SPOT DEPOSIT**

- Identified by melted or spotty deposits resembling bubbles or blisters.
- Caused by sudden acceleration. Can be cleaned.

**OVERHEATING**

- Identified by a white or light gray insulator with small black or gray brown spots and with bluish-burnt appearance of electrodes.
- Caused by engine overheating, wrong type of fuel, loose spark plugs, too hot a plug, or incorrect ignition timing. Replace the plug.

**PREIGNITION**

- Identified by melted electrodes and possibly blistered insulator. Metallic deposits on insulator indicate engine damage.
- Caused by wrong type of fuel, incorrect ignition timing or advance, too hot a plug, burned valves, or engine overheating. Replace the plug.

point file. Do not use emery cloth or sandpaper, as particles remain on the points and cause arcing and burning. If a few strokes of the file do not smooth the points completely, replace them.

If points are still serviceable after filing, remove all residue with lacquer thinner or special contact cleaner. Close the points on a piece of clean white paper such as a business card. Continue to pull the card through the closed points until no particles or discoloration remain on the card. Finally, rotate the engine and observe the points as they open and close. If they do not meet squarely, replace them.

Adjust point gap and ignition timing as described below.

Breaker Point Replacement

If breaker points are badly damaged, replace them and adjust gap as described below.

1. Remove point cover. See **Figure 48**.
2. Remove 2 lock screws securing each point set. See **Figure 49**.
3. Disconnect electrical wire from points and remove points.
4. Installation is the reverse of these steps.
5. Adjust point gap and ignition timing.

Breaker Point Adjustment

Breaker points must be examined at intervals given in **Table 1**. If in good condition, they can be cleaned and readjusted. If badly pitted, replace them and adjust the new ones as described below.

1. Remove point cover. See **Figure 48**.

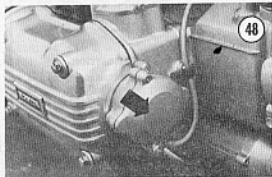

2. Remove the alternator cover hole cap. See **Figure 50**.

3. Rotate crankshaft until the left set of points opens fully. This occurs when the center of the breaker cam high point is adjacent to the point rubbing block. See **Figure 51**. Use the kickstarter or a socket wrench on the alternator rotor accessible through the hole in the cover. See **Figure 52**. Rotate alternator rotor only in the direction shown.

4. Clean and inspect the points as described under *Breaker Point Inspection and Cleaning*.

5. If points are in good condition, check gap with feeler gauge when left points are fully open. Correct gap is shown in **Table 6**.

6. To adjust point gap, loosen breaker plate lock screws (**Figure 49**) when breaker cam is at maximum lift (points fully open) and move the

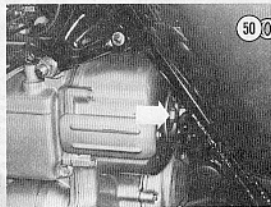
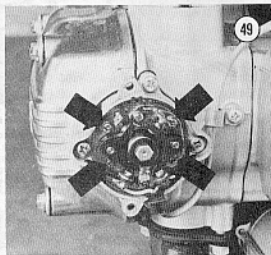
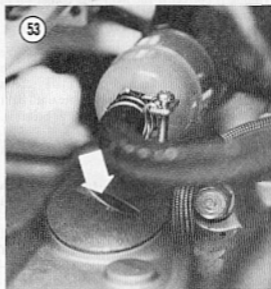
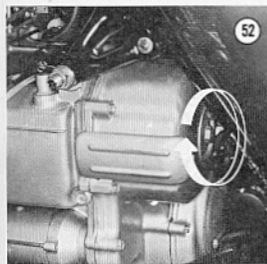
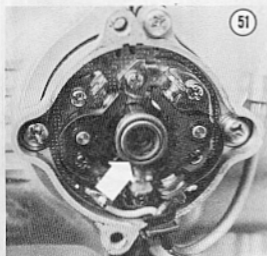

Table 6 ENGINE TUNE-UP SPECIFICATIONS

Valve clearance	0.004 in. (0.1mm) cold
Spark plug	
Type	NGK D-8EA, ND X24E5-U, Champion A8-Y (MC)
Gap	0.024-0.028 in. (0.6-0.7mm)
Breaker point	
Gap	0.012-0.016 in. (0.3-0.4mm)
Dwell	$90 \pm 2.5^\circ$ (2 cyl. scale)
Condenser capacity	0.24 mfd
Ignition timing	
Advance at idle	5° BTDC (1975-1977), 10° BTDC (1978-on)
Maximum advance	37° BTDC @ 2,300-2,600 rpm
Idle speed	950 rpm
Manifold vacuum	8-9 in. hg (21-25 cm hg)
Firing order	1-3-2-4



breaker plate to obtain correct gap. Tighten lock screws in this position.

7. Recheck gap after tightening screws.
8. Repeat Steps 3-7 for other set of points.
9. Install point cover and alternator cover hole cap.

Ignition Timing Without Strobe

After carefully adjusting point gap, adjust ignition timing.

1. Remove point cover and alternator cover hole cap.
2. Remove timing mark cap. See Figure 53.

NOTE: Do not remove cap with the engine running as considerable oil will fly out.

3. Disconnect spark plug leads to prevent engine from starting accidentally.
4. Connect 12-volt test lamp across cylinder No. 1 and cylinder No. 2 breaker points. See Figure 54.
5. Rotate the crankshaft as described under Step 3, *Breaker Point Adjustment*, until the F-1 timing mark on the alternator flywheel aligns with the timing index on the engine case. See Figure 55. Also make sure that the breaker cam dot aligns with the rubbing block on cylinders No. 1 and No. 2 breaker points. See Figure 51. Timing is correct if the light just comes on as the marks align.
6. Turn the ignition switch on.
7. If the light comes on before or after the marks align, readjust as follows. Align F-1 with the timing index. Loosen base plate screws (Figure 56) and slowly turn base plate until light just comes on. Set this as accurately as possible. Tighten base plate screws.
8. Reconnect test lamp to No. 3 and No. 4 cylinder points.
9. Turn crankshaft 180° to align F-2 mark with the timing index. If timing is correct, light will just come on.

In some cases, timing of cylinders No. 3 and No. 4 will not be correct even though timing of cylinders No. 1 and No. 2 is correct. If this occurs, follow this simple trial-and-error method.

1. Note whether cylinders No. 1 and No. 2 are advanced or retarded. That is, note whether light comes on before the F-1 aligns with the index (advanced) or after the F-1 aligns (retarded).
2. If timing of cylinders No. 1 and No. 2 are advanced, reduce No. 1 and No. 2 breaker point gap as described under *Breaker Point Adjustment*. If timing is retarded, increase the gap. In any case, point gap must still be 0.012-0.016 in. (0.3-0.4mm).
3. With F-1 still aligned with the index, loosen the base plate and move it until test light on cylinders No. 1 and No. 2 breaker points just lights. Tighten base plate screws.

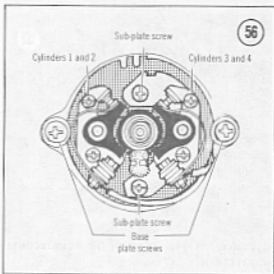
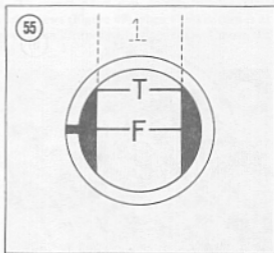
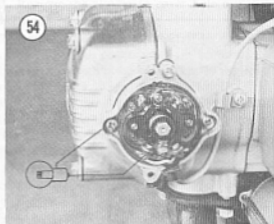

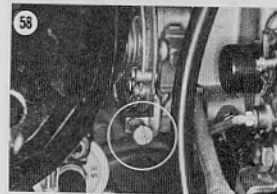
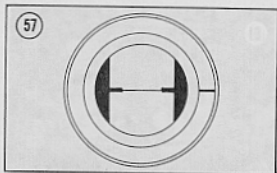

4. Rotate crankshaft 180° counterclockwise to align F-2 with index. Connect test light to cylinder No. 3 and No. 4 points.

5. Loosen lock screws on cylinders No. 3 and No. 4 breaker points and move cylinders No. 3 and No. 4 breaker points until light just comes on. Tighten lock screws.

6. Check cylinders No. 3 and No. 4 breaker points to be sure they are within 0.012-0.016 in. (0.3-0.4mm).

7. Repeat entire procedure as often as necessary until point gap of both sets is within range and timing light comes on at proper point.

Ignition Timing with Strobe

This procedure requires a special timing cap (Honda HC63068) for the timing hole. If not used, considerable oil mist will fling out over the engine. Order cap from your dealer.

1. Remove timing hole cover and install special timing cap.

2. Connect strobe to No. 2 spark plug (front cylinder, left side) following the manufacturer's instructions.

3. Start the engine and set idle at speed shown in Table 6.

4. Point the strobe light at the timing marks visible through the timing hole. The F mark should align with the timing index. See Figure 55.

5. Increase engine speed to 3,000 rpm. The lines shown in Figure 57 should align with the timing index, indicating that the automatic advance mechanism is producing full advance.

6. If timing in Step 4 is off, loosen the base plate screws (Figure 56) and rotate the plate until timing is correct. Rotating the plate clockwise advances the timing; counterclockwise retards the timing. Tighten the base plate screws when timing is correct.

7. Stop the engine and recheck the breaker point gap for cylinders No. 1 and No. 2.

8. Connect the strobe to No. 4 spark plug (rear cylinder, left side) following the strobe manufacturer's instructions.

9. Repeat Steps 3-5 for cylinders No. 3 and No. 4.

10. If timing is incorrect, loosen 2 screws shown in Figure 56 and rotate the sub-plate. Rotating the sub-plate clockwise advances timing; rotating the sub-plate counterclockwise retards the timing.

11. Stop the engine and recheck breaker point gap for cylinders No. 3 and No. 4.

Carburetor Idle Adjustment

Before making this adjustment, the air cleaner must be clean, the ignition system must be properly adjusted, and the engine must have adequate compression. Otherwise, this procedure cannot be done properly.

NOTE: If the bike is operated above 6,000 feet (approximately 2,000 meters) the idle speed may have to be readjusted to that specified in Table 6.

1. Make sure that throttle free-play is 10-15 degrees. Adjust as shown in Figures 25A and 25B.

2. Warm the engine to normal operating temperature. See Figure 17.

3. Adjust idle to speed shown in Table 6 with the screw shown in Figure 58.

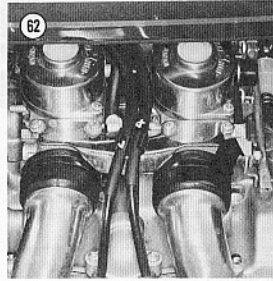
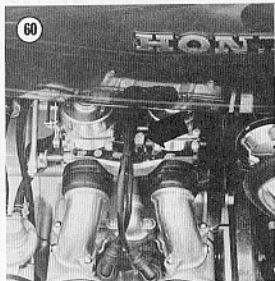
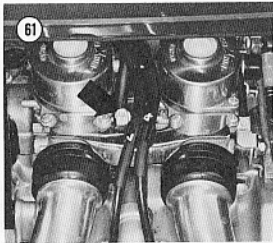
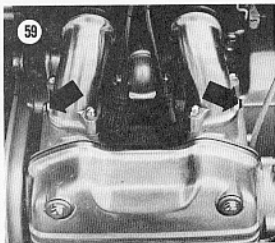

4. If idle speed cannot be adjusted properly, synchronize the carburetors as described under *Carburetor Synchronization* below.

Carburetor Synchronization

This procedure requires a special tool to measure manifold vacuum for all 4 cylinders simultaneously. See description under *Tools and Equipment* in Chapter One.

1. Connect synchronizing gauge set to all 4 intake manifolds. See **Figure 59**.
2. Start engine and warm to normal operating temperature. See **Figure 17**.
3. Adjust idle speed to rpm specified in **Table 6**. See **Figure 58**.

4. Note manifold vacuum of cylinders No. 1 and No. 3 (right bank). Adjust equalizer screw (**Figure 60**) until both cylinders read the same vacuum.

5. Note manifold vacuum of cylinders No. 2 and No. 4 (left bank). Adjust equalizer screw (**Figure 61**) until both cylinders read the same vacuum.

6. Adjust linkage with screw shown in **Figure 62** to equalize manifold pressure between the left and right bank.

7. Readjust idle speed to rpm specified in **Table 6** if necessary.

8. Repeat Steps 4-6 as often as necessary until all 4 cylinders have the same manifold vacuum.

STORAGE

Several months of inactivity can cause serious problems and general deterioration of your bike. This is especially important in areas with extremely cold winters. During the winter, you should prepare your bike carefully for "hibernation."

Selecting a Storage Area

Most cyclists store their bikes in their home garage. If you do not have a garage, there are other facilities for rent or lease in most areas. When selecting an area, consider the following points.

1. The storage area must be dry; there should be no dampness or excessive humidity. A heated area is not necessary, but it should be insulated to minimize any extreme temperature variations.
2. Avoid buildings with large window areas. If this is not possible, mask the window to keep direct sunlight off the bike.
3. Avoid buildings in industrial areas where factories are liable to emit corrosive fumes. Also avoid buildings near large bodies of salt water.
4. Select an area where there is minimum risk of fire, theft, or vandalism. Check with your insurance agent to make sure that your insurance covers the bike where it is stored.

Preparing Bike for Storage

Careful preparation will minimize deterioration and make it easier to restore the bike to service later. Use the following procedure.

1. Wash the bike completely. Make certain to remove any road salt which may have accumulated during the first weeks of winter. Wax all painted and polished surfaces, including any chromed areas.
2. Run the engine for 20-30 minutes to stabilize oil temperature. Drain oil, regardless of mileage since last oil change. Replace the oil

filter and fill engine with normal quantity of fresh oil.

3. Remove battery and coat cable terminals with petroleum jelly. If there is evidence of acid spillage in the battery box, neutralize with baking soda, wash clean, and repaint the damaged area. Store the battery in a warm area and recharge it every 2 weeks.
4. Drain all gasoline from fuel tank, interconnecting hoses, and carburetors. Leave fuel petcock in the RESERVE position. As an alternative, a fuel preservative may be added to the fuel. This preservative is available from many motorcycle shops and marine equipment suppliers.
5. Remove spark plugs and add a small quantity of oil to each cylinder. Turn the engine a few revolutions by hand to distribute the oil and install the spark plugs.
6. Run a paper card, lightly saturated with silicone lubricant, between the points.

CAUTION

Do not use any other type of lubricant or the points will be burned when the bike is restored to service.

7. Check tire pressures. Move machine to storage area and store it on the centerstand.
 8. Drain the entire cooling system as described under *Changing Coolant*. A label or tag should be firmly attached in a conspicuous place, for example, taped over the instruments or ignition switch, indicating the system is empty.
- Rather than leave the system empty, a better way is to refill the system with an ethylene glycol anti-freeze solution. Be sure it is rated for year-round protection and made expressly for aluminum engines. Dilute the anti-freeze to protect well below the lowest temperature likely in the area. Ethylene glycol is also an effective corrosion inhibitor. This same mixture may be left in the system when the engine is returned to service and only replaced prior to each storage period.

NOTE: If you own a 1980 or later model, first check the Supplement at the back of the book for any new service information.

CHAPTER FOUR

ENGINE

The engine is a water-cooled, horizontally opposed 4-cylinder with a single overhead camshaft for each cylinder bank. Three main bearings support the counterweighted crankshaft in the split crankcase. Toothed Gilmer belts drive the camshafts from the crankshaft. A Hy-Vo primary chain drives the clutch from the crankshaft. The left camshaft drives the breaker points, while the right camshaft drives the tachometer and mechanical fuel pump. The camshafts operate the valves through rocker arms.

There are two oil pumps in the engine. The main oil pump supplies oil under pressure throughout the engine. The clutch oil pump simply scavenges oil from the clutch area and returns it to the sump. The main oil pump also drives the water pump impeller on the front of the engine.

This chapter provides complete service and overhaul procedures for the GL-1000 engine. **Figures 1 through 5** show several views of the engine with major components identified. **Table 1** at the end of this chapter provides complete specifications for the engine. Although the clutch and transmission are mounted in the engine, they are covered separately in Chapter Five to simplify the presentation of this material.

ENGINE REMOVAL

1. Rest bike on centerstand. Remove accessories such as fairing and crash bars.
2. Drain engine oil.
3. Drain coolant as described under *Changing Coolant* in Chapter Three.
4. Remove radiator as described in Chapter Eight.
5. Remove 2 bolts securing fuel pump assembly to cylinder head. Tie the fuel pump up out of the way. See **Figure 6**.
6. Disconnect spark plug wires and tie them up out of the way.
7. Remove 2 bolts securing horn to bracket. Disconnect horn wires from front bracket. Unplug horn from wiring harness.
8. Disconnect wires from water temperature sender and fan control switch on thermostat housing. See **Figure 5**. Pull wires free of front bracket.
9. Disconnect wire from oil sender on right side of engine. See **Figure 7**.
10. Disconnect breaker points and alternator cables. See **Figure 8**.
11. Disconnect wire from starter. See **Figure 9**.
12. Remove acorn bolts securing intake manifolds to cylinder heads. See **Figure 10**. The carburetors are not removed with the engine.

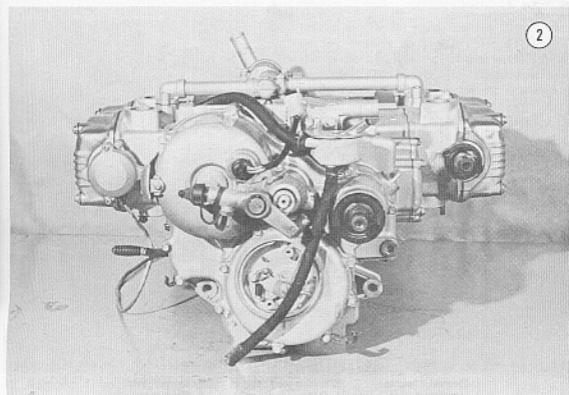
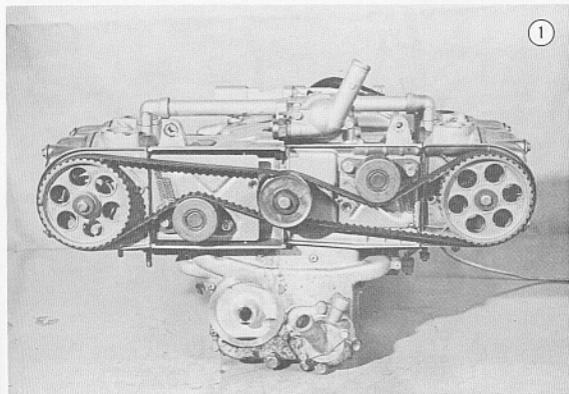

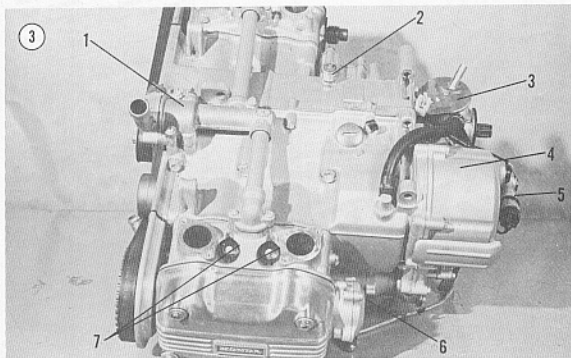

1. Thermostat housing
2. Oil pressure sender
3. Breather collector

4. Alternator
5. Kickstarter

6. Breaker point cover
7. Spark plugs

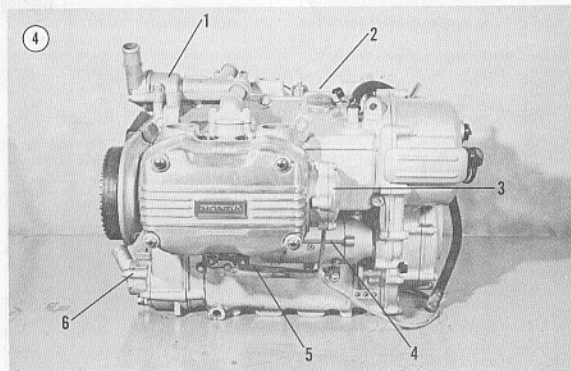

1. Thermostat housing
2. Timing mark cover

3. Breaker point cover
4. Starter

5. Gearshift lever
6. Water pump

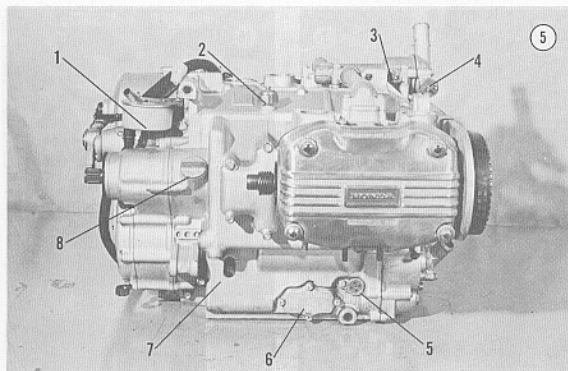

1. Breather collector
2. Oil pressure sender
3. Water temperature sender

4. Fan control switch
5. Neutral switch
6. Oil screen

7. Oil level window
8. Oil filter cap

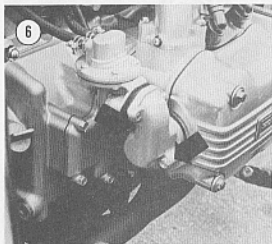

13. When carburetor assembly is free, hold it up clear of the engine with a couple of bungee cords.

14. Disconnect hose from breather collector box on right side of engine. See Figure 11.

15. Remove 4 bolts securing each exhaust

header to cylinder head. Loosen clamps connecting headers to muffler. See Figure 12. Disconnect and remove left header from bike. Disconnect right header from cylinder head and rotate it away from the head; it is not necessary to remove it.

16. Remove 4 bolts (2 each side) indicated in Figure 13.

17. Remove right rear engine mounting bolt. See Figure 14.

18. Remove left rear engine mounting bolt. See Figure 15.

19. Remove 2 bolts securing thermostat housing to engine. See Figure 16. Remove front bracket. See Figure 17. Reinstall thermostat housing so that the parts will not get damaged.

20. Remove 2 bolts securing clutch cover and remove cover. Disconnect the clutch cable at the clutch end.

21. Pull back drive shaft boot. Remove circlip on end of U-joint spine with right-angle circlip pliers. See Figure 18. Push the U-joint toward the rear.

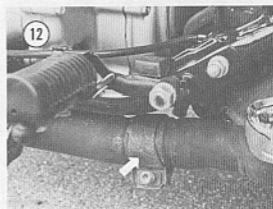
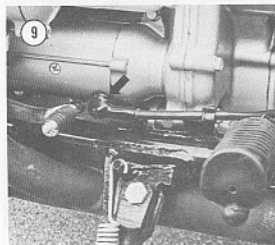
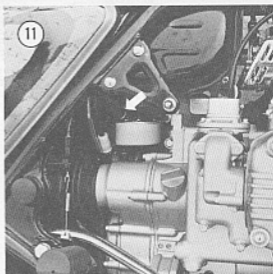
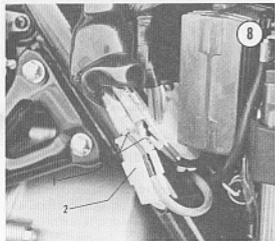
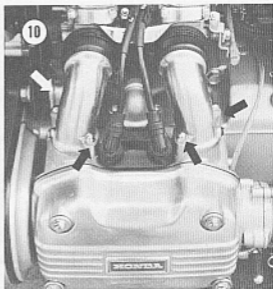
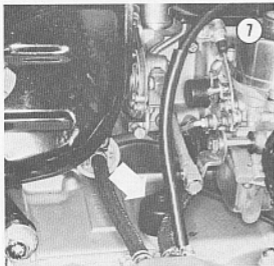

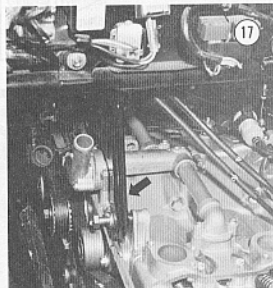
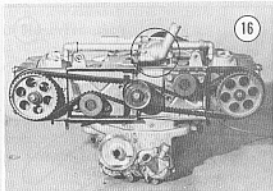
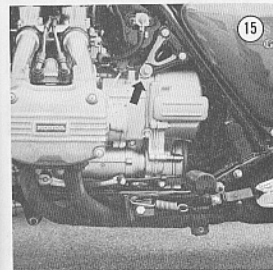
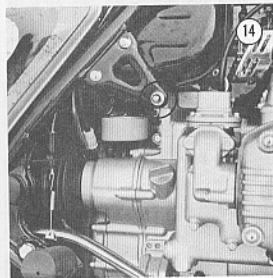
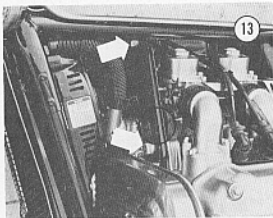

NOTE: *If you are very careful, you can pry the circlip off with a thin bladed screwdriver or stout knife blade and not damage the drive shaft, but the circlip will be damaged. It is much better to use the circlip pliers. You will need them in any event to install a new circlip later.*

22. Place floor jack under engine. Use wood blocks to protect engine from jack. Raise jack just enough to support the engine weight.

23. Remove left frame section. To do this, remove the following fasteners shown in Figure 19.

- Two acorn nuts at forward end
- One nut at rear end
- One nut on lower through bolt
- One through bolt at rear
- One bolt above side stand

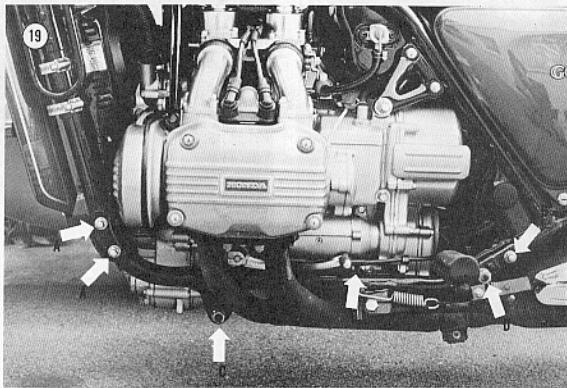
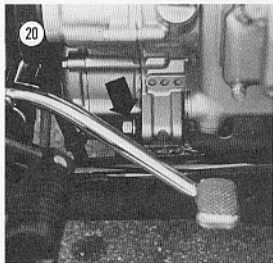
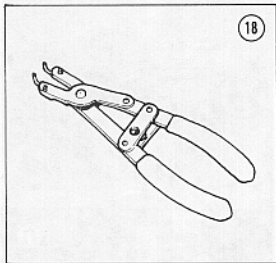

24. Remove engine mounting bolt shown in Figure 20.

NOTE: At this point the engine is free. Make sure that it is solidly balanced on the floor jack.

25. Push engine as far forward as possible.

26. Slide the drive shaft back by prying it with a wide-bladed screwdriver. Do not damage the boot or any metal surfaces.

27. As soon as the neutral switch screw is accessible, disconnect the wire and move it clear of the engine. See Figure 5 for switch location.

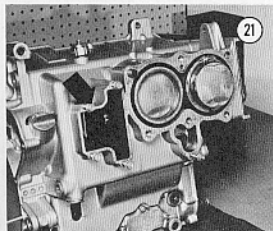

28. Take one final look all over the engine to make sure everything has been disconnected.
29. Slide the engine away from the frame. Jockey it around as necessary to clear all frame components.

NOTE: Another way is to leave the engine in place on the jack and jockey the frame away from the engine. This works better if your jack is not very maneuverable.

ENGINE DISASSEMBLY/ASSEMBLY

The following sequences are designed so that the engine need not be disassembled any further than necessary. Unless otherwise indicated, procedures for major assemblies in these sequences are included in this chapter. The procedures are arranged in the approximate order in which they are performed.

To perform a step, turn to the procedure for the major assembly indicated, e.g., cylinder head, and perform the removal and inspection procedures, etc., until the engine is disassembled. To reassemble, reverse the disassembly sequence and perform the installation procedure for the major assembly involved.

Decarbonizing or Valve Service

The following service is possible with the engine in the frame.

1. Remove radiator if engine is in the frame. See Chapter Eight.

2. Remove camshaft drive belt covers.
3. Remove camshaft drive belts.
4. Remove fuel pump if engine is in frame.
5. Remove valve covers.
6. Remove camshaft/rocker arm assemblies.
7. Remove cylinder heads.
8. Remove and inspect valves, guides, and seats.
9. Assembly is the reverse of these steps.

General Overhaul

1. Remove engine from the frame.
2. Remove camshaft belt covers.
3. Remove camshaft drive belts.
4. Remove valve covers.
5. Remove camshaft/rocker arm assemblies.
6. Remove cylinder heads.
7. Remove kickstarter assembly.
8. Remove clutch.
9. Remove rear engine cover.
10. Remove alternator rotor.
11. Remove alternator stator windings from rear engine cover.
12. Remove final drive shaft from the rear engine cover.
13. Remove clutch housing and drive chain.
14. Remove plate shown in **Figure 21** and slide final drive idler gear out.
15. Remove starter.
16. Remove alternator drive shaft.
17. Remove water connection from the top of the engine.
18. Remove water pump.
19. Remove front engine cover.
20. Remove necessary bolts and split the engine cases.
21. Remove crankshaft.
22. Remove transmission main shaft.
23. Remove right pistons.
24. Lift out primary chain oiler.
25. Remove clutch shifter selector stops.
26. Remove selector fork shaft and forks.
27. Remove transmission countershaft.
28. Remove neutral switch and shifter drum.

22

ENGINE OIL PUMP

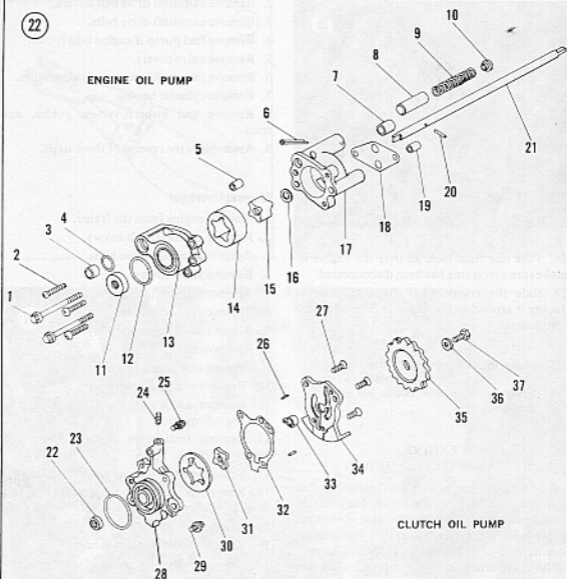

- | | | | |
|------------------------|-------------------|-------------------|-----------------|
| 1. Bolt | 11. Oil seal | 20. Pin | 29. Bolt |
| 2. Screw | 12. O-ring | 21. Shaft | 30. Outer rotor |
| 3. Collar | 13. Oil pump body | 22. Oil seal | 31. Inner rotor |
| 4. O-ring | 14. Outer rotor | 23. O-ring | 32. Gasket |
| 5. Dowel pin | 15. Inner rotor | 24. Sealing screw | 33. Collar |
| 6. Cotter pin | 16. Washer | 25. Bolt | 34. Pump cover |
| 7. Dowel pin | 17. Pump base | 26. Dowel pin | 35. Sprocket |
| 8. Relief valve | 18. Gasket | 27. Screw | 36. Washer |
| 9. Relief valve spring | 19. Dowel pin | 28. Pump body | 37. Bolt |
| 10. Relief valve seat | | | |

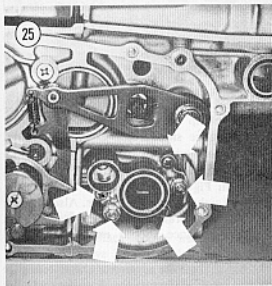
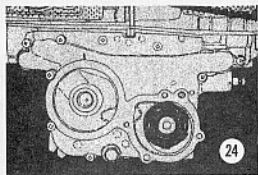
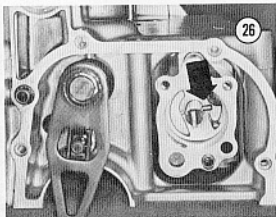
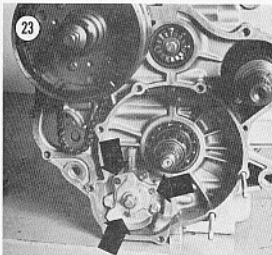

CLUTCH OIL PUMP

Removal/Installation

Refer to Figure 22 for this procedure.

1. Remove clutch cover and rear engine case as described under *Rear Cover Removal/Installation* procedure.
2. Remove clutch and clutch housing. See Chapter Five.
3. Loosen 3 Phillips screws shown in Figure 23 but do not remove them.
4. Remove 3 bolts securing clutch oil pump.
5. Remove 3 Phillips screws loosened in Step 3.
6. Lift off drive collar, then the rotor and impeller.
7. Assembly is the reverse of these steps. Replace the oil seals at the back of the pump. Install the impeller and rotor with punch marks facing out.

MAIN OIL PUMP

Removal/Installation

Refer to Figure 22 for this procedure.

1. If engine is still in the frame, drain the engine oil and the coolant. See Chapter Three.
2. Remove front cover. See Figure 24.
3. Remove 3 screws and 2 bolts shown in Figure 25.
4. Lift pump cover off.
5. Lift out rotor and impeller.
6. Push out drive pin. See Figure 26. Also remove washer.

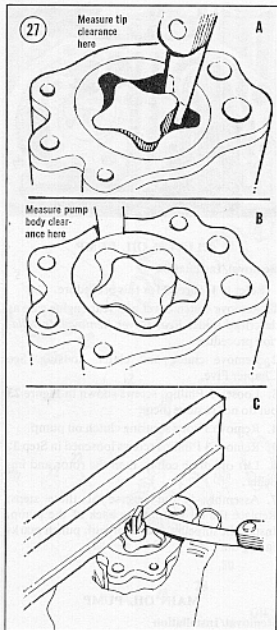

CAUTION

Do not let the pin drop into the engine case or you will have to disassemble the case to retrieve it.

7. Slide pump body out.
8. Remove cotter pin, relief valve, spring, and seat. See Figure 22.
9. Check the impeller and rotor for signs of wear or damage.

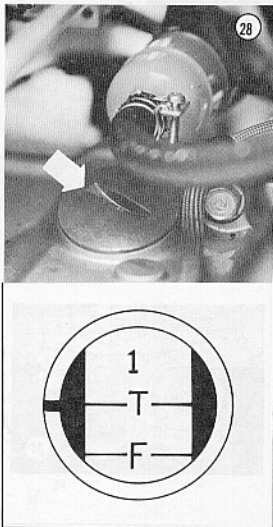

10. Measure the clearance between the rotor tip and the impeller as shown in Figure 27A. The clearance should not exceed 0.0138 in. (0.35mm).
11. Check the clearance between the impeller and the pump body as shown in Figure 27B. The clearance should not exceed 0.0157 in. (0.40mm).
12. Lay a straightedge across the pump as shown in Figure 27C. Measure clearance between straightedge and the rotor. Also measure between the straightedge and the impeller. Neither clearance should exceed 0.0047 in. (0.12mm).
13. Assembly is the reverse of these steps. Use a new gasket. Make sure that impeller and rotor

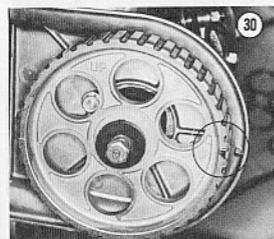
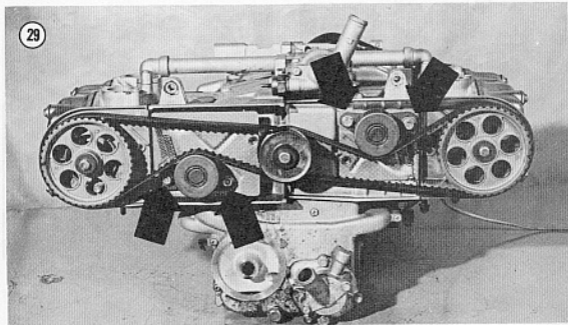

are installed with punch marks facing out. Replace the O-rings and seal in the cover.

CAUTION

The oil pump cover fits on the body without a gasket. If you use a gasket, oil pressure will be dangerously low.

CAMSHAFT BELT REPLACEMENT

1. Remove 2 black acorn nuts at top of radiator. Remove 2 black bolts at bottom of radiator. Pull the radiator forward as much as possible to gain clearance in front of the engine.

2. Remove 4 bolts securing the camshaft belt covers.

3. Remove timing mark cap (Figure 28) and rotate crankshaft until the T1 mark is visible and lined up with the case marker. See Figure 28. This puts cylinder No. 1 at top dead center (TDC).

4. Loosen belt tensioner bolts (Figure 29).

5. Slide the belts off the camshaft pulley first, then the crankshaft pulley.

6. Check again that the T1 mark is lined up and the pulleys are aligned exactly as described in Step 3.

7. Make sure that the UP mark on each camshaft pulley is near the top, and the small arrow lines up *exactly* with the mark on the pulley backing plate. See Figure 30. If not, rotate the camshaft pulley as necessary.

CAUTION

Steps 6 and 7 are very important as they establish the valve timing. If not done accurately, the consequences may range from poor running to complete destruction of the engine.

8. Install camshaft belts. Loosen tensioners further if necessary. When belts are in place, let

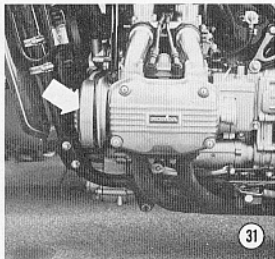

the tensioner springs apply tension to the rollers, then tighten the tensioner bolts; do not apply additional force.

9. Install camshaft belt covers.
10. Install radiator.

CAMSHAFT AND ROCKER MECHANISM

Removal

If the engine is still in the frame, begin with Step 1; if the engine has been removed, begin with Step 2.

1. Remove 2 black acorn nuts at the top of the radiator. Remove 2 black bolts at bottom of radiator. Pull the radiator forward as much as possible to gain clearance in front of the engine.

NOTE: There is some danger of damaging the radiator with tools during the following steps. Consider removing the radiator entirely as described in Chapter Eight; it only takes a few more minutes at this point.

2. Remove 4 bolts securing camshaft belt covers. See **Figure 31**.
3. Loosen 2 belt tensioner bolts on each tensioner (**Figure 29**) and slide the belts off.
4. Rotate each pulley as necessary to gain access to the 2 bolts underneath. See **Figure 32**. Remove the bolts.
- 5a. On right side, disconnect fuel pump from cylinder head.

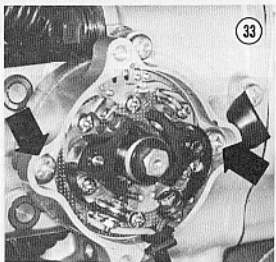
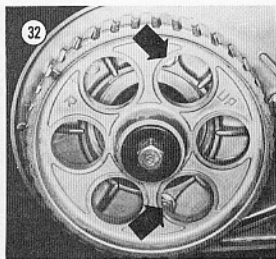

- 5b. On left side, remove breaker point cover. Remove breaker points by removing 2 screws shown in **Figure 33**. Remove bolt on end of cam and slide advance mechanism off.

6. Remove valve covers.
7. Remove 6 bolts securing the rocker shaft holders. See **Figure 34**.
8. Lift off entire valve operating mechanism and camshaft. Tap the assembly lightly with a soft mallet if necessary to loosen it.
9. Separate the camshaft from the rocker shaft holder.
10. Remove pulley bolt. Remove pulley, Woodruff key, backing plate, seals, and gasket from camshaft.

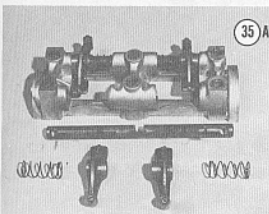
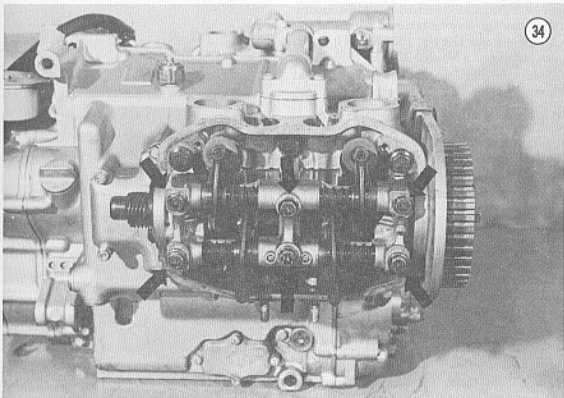

Rocker Mechanism Disassembly/Assembly

It is important that all parts be assembled in their original positions. Therefore, before disassembling, mark the parts in some way to remind you later.

1. Push one of the rocker shafts out of the holder.
2. Remove the springs and rocker arms. See Figure 35A.

3. Push the other rocker shaft out and remove the springs and rocker arms.

4. Clean all parts thoroughly in solvent.

5. Carefully inspect the rocker arm bore and bearing faces for signs of wear or scoring. Replace them if defective.

6. Inspect the rocker shafts for signs of wear or scoring.

7. Check springs for distortion or breakage.

8. Coat rocker shafts, holder bores, and rocker arm bores liberally with assembly lubricant.

9. Slide the rocker shafts into the holder while assembling the rocker arms and springs on the shaft. When completed, the mechanism should look like Figure 35B. Note that the small oil holes in the shafts must point downward and inward. See Figure 36.

Camshaft Inspection

1. Check bearing journals for wear and scoring. Measure journal with a micrometer. Compare measurements to Table 1.
2. Check cam lobes for wear. The lobes should

not be scored and the edges should be square. Slight damage may be removed with a silicon carbide oilstone. Use No. 100-120 grit initially, then polish with a No. 280-320 grit.

3. Measure cam lobes with a micrometer as shown in Figure 37. Compare with cam lobe specification in Table I.

4. Check camshaft bearing bores in the cylinder head and the rocker shaft holder. Bores should not be excessively worn or scored.

5. Check the tachometer drive gear teeth on the right camshaft for wear and damaged teeth.

Installation

1. Coat the camshaft lobes and journals with assembly lubricant. Also coat the bearing bore halves in the cylinder halves in the cylinder head and the rocker shaft holder.

2. Coat the camshaft seals with assembly lubricant and slide them on the camshaft.

3. Install the camshaft in the head and seat the seals. See Figure 38.

4. Install the rocker shaft holder. Make sure the camshaft seals seat properly in the holder.

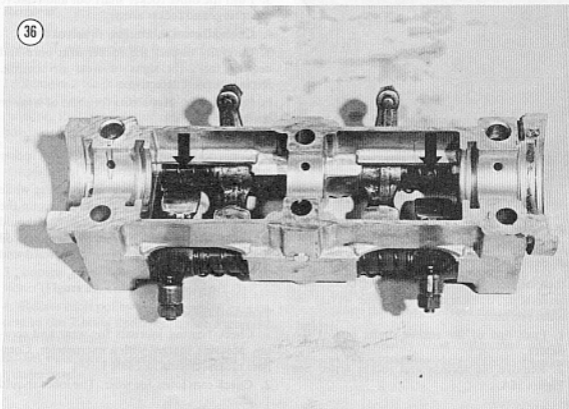
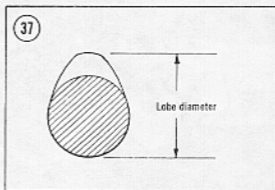
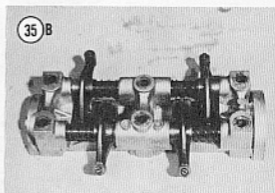

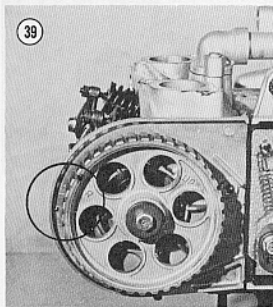
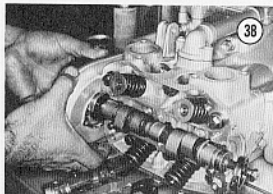

Tighten the 6 bolts to 18-21 ft.-lb. (2.5-2.9 mkg).

5. Install camshaft pulley back plate with a new gasket. Tighten mounting bolts to 6-9 ft.-lb. (0.8-1.2 mkg).

6. Install camshaft pulley with Woodruff key. Tighten pulley bolt to 18-21 ft.-lb. (2.5-2.9 mkg).

NOTE

The camshaft pulleys are identical but mount differently on the left and right sides. On the right camshaft, mount the pulley with the boss facing out; the embossed "R" should be visible. See Figure 39. On the left camshaft mount the pulley with the boss inward; there is no embossed mark visible when mounted

on the left side other than the "UP" mark.

7. Install and adjust camshaft belts. See *Camshaft Belt Replacement*.

CAUTION

Do not bend or twist the belt unnecessarily. This would break the glass fibers and weaken the belt. Follow procedure exactly. Valve timing depends on proper installation. Very expensive damage could result from improper installation.

8. Install belt covers.

9. Install radiator. Refill cooling system if radiator was removed entirely.

10. Install fuel pump.

11. Slide advance mechanism onto end of left camshaft. Secure with bolt.

12. Install breaker plate and secure with 2 screws. See Figure 33.

13. Adjust ignition timing and install breaker point cover. See Chapter Three.

CYLINDER HEADS

Removal

The cylinder heads can be removed without removing the engine from the frame.

1. If engine is still in frame, remove exhaust header(s). See Chapter Six.

2. Remove camshaft and rocker mechanism as described under *Camshaft and Rocker Mechanism Removal* in this chapter.

3. Remove 6 cylinder head bolts shown in Figure 40. Also remove 10mm bolt at bottom of head.

4. Loosen head with a soft mallet and pull the head off.

NOTE: Another way to loosen a cylinder head is to install the spark plugs (if previously removed) and rotate the crankshaft with the kickstarter or electric starter. Engine compression is often strong enough to break the head loose.

NOTE: The top water connection is a slide fit. It is not necessary to remove the water plumbing.

5. Remove the oil restrictor orifice from the crankcase. See Figure 41.

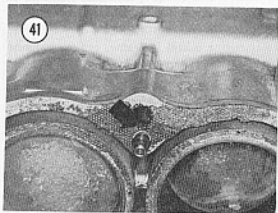
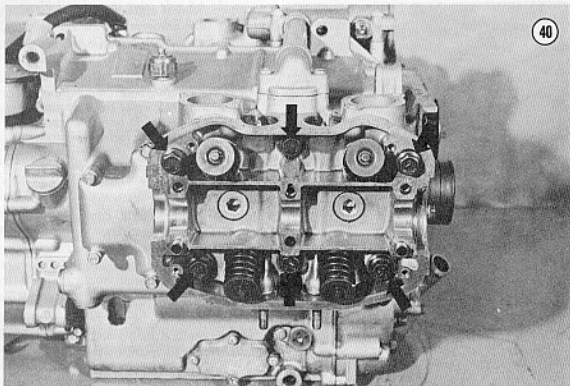

Inspection

1. Remove all traces of gasket from head and crankcase mating surface.

CAUTION

Do not let any gasket particles drop into the water passages. They could clog the cooling system and cause considerable damage.

2. Without removing the valves, remove all carbon deposits from the combustion chambers

with a wire brush. A blunt screwdriver or chisel may be used if care is taken not to damage the head or valves.

3. After all carbon is removed from combustion chambers, valve intake and exhaust ports, clean the entire head in solvent.

4. Clean away all carbon on the piston crowns. Do not remove carbon ridge at the top of the cylinder bore.

5. Check for cracks in the combustion chamber

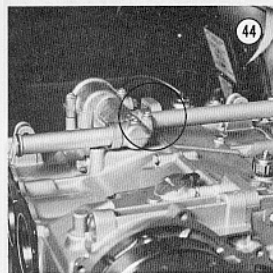
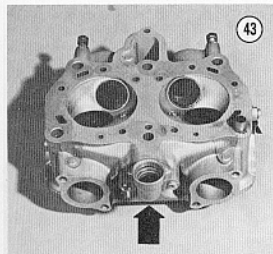

and exhaust ports. Cracked heads must be replaced.

6. Check all studs for tightness. If a stud cannot be tightened, have a machinist drill the hole out and install a Heli-coil threaded insert.

7. Push the valve stem ends sideways with your thumb. If there is any play, the valve guides are probably worn. Replace them as described under *Valve Guide Replacement* if in doubt.

Installation

1. Install oil restrictor orifice with 2 new O-rings. See **Figure 42**.
2. Install water connection on top of cylinder head if removed. See **Figure 43**.

3. Slide water pipe into water connection. Use new O-rings and coat the O-rings with Gaseqinch or equivalent.

4. Install cylinder head with new head gasket. Do not use sealer on gasket. Push head fully into place. Make sure that the water pipe enters the thermostat housing. See **Figure 44**.

5. Install six 10mm cylinder head bolts. Torque all of them in the sequence shown in **Figure 45** to 25 ft.-lb. (3.5 mkg). Repeat the sequence and torque them to the final torque of 37-40 ft.-lb. (5.3-5.7 mkg).

6. Install 6mm bolt at bottom of head. Torque to 7-10 ft.-lb. (1-1.4 mkg).

7. Install camshaft and rocker mechanism as described under *Camshaft and Rocker Mechanism Installation*.

VALVES AND VALVE SEATS

Removal

Refer to **Figure 46** for this procedure.

1. Remove cylinder heads as described under *Cylinder Head Removal*.
2. Compress springs with a valve spring compression tool (**Figure 47**), remove the valve keepers, and release compression.
3. Remove the valve spring caps, springs, and valves. See **Figure 46**.

CAUTION

Remove any burrs from valve stem grooves before removing the valve; otherwise the valve guides will be damaged.

Inspection

1. Clean valves with a wire brush and solvent. Discard burned, warped, or cracked valves. If any valves are to be resurfaced, have this done by your dealer or local machine shop.
2. Measure the valve stems for wear. Compare with specifications in **Table 1**.
3. Remove all carbon and varnish from the valve guides with a stiff spiral wire brush.
4. Insert each valve in its guide. Hold the valve just slightly off its seats and rock it sideways. If it rocks more than slightly, the guide is probably worn and should be replaced. As a final check, take the head to a dealer and have the valve guides measured.

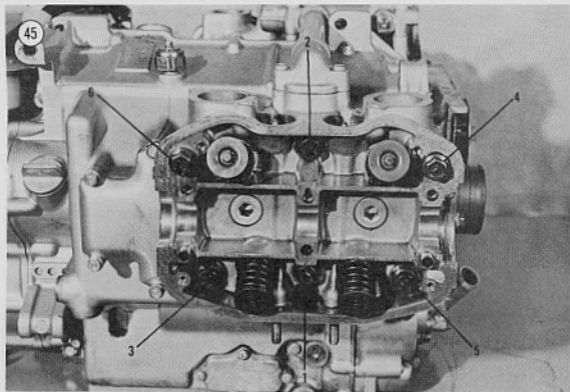

5. Measure the valve spring heights. All should be of length specified in **Table 1** with no bends or other distortion. Replace defective springs.

6. Check the valve spring retainer and valve keepers. If they are in good condition, they may be reused.

7. Inspect valve seats. If worn or burned, they must be reconditioned. This should be performed by your dealer or local machine shop, although the procedure is described later in this section. Seats and valves in near-perfect condition can be reconditioned by lapping with fine carborundum paste. Lapping, however, is always inferior to precision grinding.

Installation

1. Coat the valve stems with molybdenum disulphide paste and insert them into cylinder head.
2. Install bottom spring retainers and new seals. See **Figure 48**.
3. Install valve springs and upper valve spring retainers.

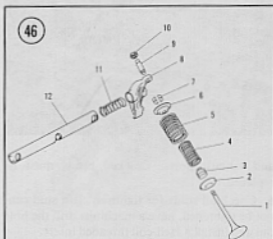

VALVE TRAIN

- | | |
|---------------------|------------------|
| 1. Valve | 7. Cotter |
| 2. Spring seat | 8. Rocker arm |
| 3. Valve guide seal | 9. Adjuster |
| 4. Inner spring | 10. Locknut |
| 5. Outer spring | 11. Spring |
| 6. Retainer | 12. Rocker shaft |

4. Push down on upper valve spring retainers with the valve spring compressor and install valve keepers.

Valve Guide Replacement

When guides are worn so that there is excessive stem-to-guide clearance or valve tipping, they must be replaced. Replace all, even if only one is worn. This job should only be done by a dealer as special tools are required.

Valve Seat Reconditioning

This job is best left to your dealer or local machine shop. They have the special equipment and knowledge for this exacting job. You can still save considerable money by removing the cylinder heads and taking just the heads to the

shop. The following procedure is provided in the event you are not near a dealer and the local machine shop is not familiar with GL-1000.

1. Using a 45° valve seat cutter, cut the 45° face. Do not take off any more metal than is necessary to provide a clean, concentric seat about 0.10 in. (2.5mm) wide.
2. Narrow the inside edge of 45° seat with a 37.5° cutter by about 0.02 in. (0.5mm).
3. Narrow the outside edge of the 45° seat with at 63.5° cutter until the seat width is 0.055 in. (1.4mm). See Figure 49.
4. Coat the corresponding valve face with Prussian blue.
5. Insert the valve into the guide.

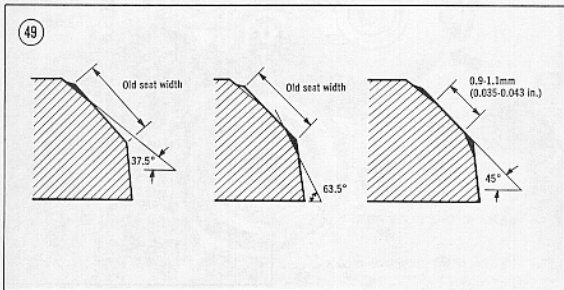
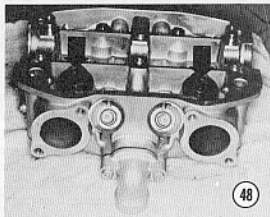
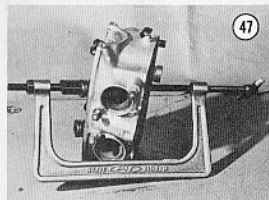

6. Rotate the valve under light pressure approximately $\frac{1}{4}$ turn.

7. Lift the valve out. If the valve seats properly, the blue will transfer to valve seat face evenly.

8. Clean Prussian blue off.

REAR COVER

The engine must be removed from the frame to remove the rear cover.

Removal

1. Remove all clutch parts except clutch housing as described in Steps 1-5, *Clutch Removal*, in Chapter Five.

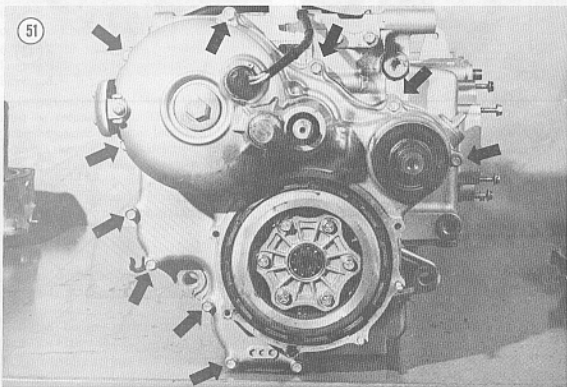
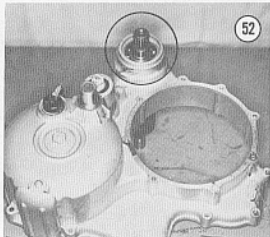
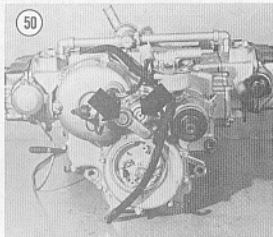

2. Remove snap ring on kickstarter arm and pull the arm off. See **Figure 50**.
3. Remove snap ring on kickstarter cam and pull cam off. See **Figure 50**.
4. Remove 11 bolts shown in **Figure 51**.
5. Tap the rear cover off with a *plastic* mallet.

Installation

1. Remove all traces of gasket from sealing surfaces of rear cover and crankcase.
2. Apply thin coat of Gasgacinch or equivalent to crankcase and rear cover.
3. Install clutch housing and secure with snap ring if removed.
4. Install rear cover. Tighten bolts to 7-10 ft.-lb. (1.0-1.4 mkg).
5. Install kickstarter cam with snap ring. Cam portion should face down.
6. Install kickstarter arm with snap ring. Make sure that there is a fiber washer on each side of the arm.
7. Install remaining clutch parts as described under *Clutch Installation* in Chapter Five.

OUTPUT SHAFT

Removal/Installation

1. Remove rear cover as described under *Rear Cover Removal*.
2. Remove snap ring securing the output shaft in the rear cover and slide the shaft out. See **Figure 52**.
3. Installation is the reverse of these steps.

Disassembly/Assembly

The output shaft must be disassembled with a press as the spring is under considerable tension. Inspect all parts as well as possible without disassembly. If there is any evidence of wear, take the drive shaft to your dealer.

WARNING

Improvised tools could be very dangerous.

ALTERNATOR ROTOR

Removal

1. Remove rear cover as described under *Rear Cover Removal*.

2. Remove bolt in center of rotor. To hold the rotor, insert a large drift in one of the holes around the circumference of the rotor. See **Figure 53**.
3. Slide the rotor off.
4. Slide thrust washer off.

Inspection

The rotor is permanently magnetized, and cannot be remagnetized. If dropped, the magnetism can be lost. There is no way to check it except by replacement with a known good rotor.

Starter Clutch Disassembly/Assembly

The starter clutch absorbs shocks in the system during starting. These parts are located in the alternator rotor.

1. Remove alternator rotor as described above.
2. Carefully pry each clutch roller out. See **Figure 54**. Remove springs and spring caps.
3. Clean all parts in solvent.
4. Make sure clutch parts are not magnetized. If they show magnetic attraction for each other, replace them, otherwise the clutch will act erratically.
5. Grease clutch parts very lightly with silicone (high temperature) grease.
6. Insert caps, springs, and rollers, orienting them as shown in **Figure 55**.

Installation

1. Slide splined thrust washer onto alternator drive shaft.
2. Slide rotor onto shaft. Make sure that the starter clutch parts stay in place.
3. Install center bolt and torque it to 58-69 ft.-lb. (8.0-9.0 mkg). Use a drift to hold the rotor as described in Step 2, *Removal*.
4. Install rear cover.

ALTERNATOR DRIVE SHAFT

Removal

1. Remove alternator rotor as described under *Alternator Rotor Removal* in this chapter.

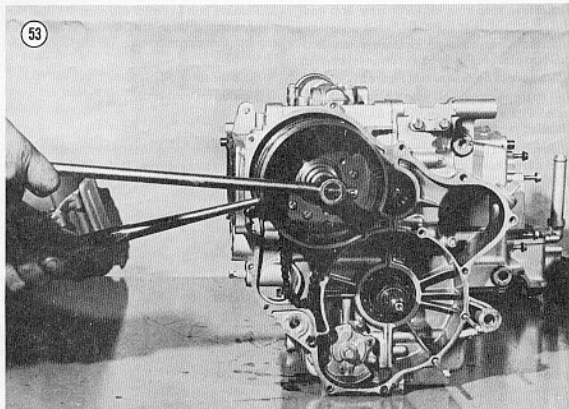

2. Remove bolt securing starter drive sprocket retainer. See Figure 56.
3. Slide starter drive sprocket and chain off drive shaft.
4. Remove 5 bolts securing alternator drive shaft (Figure 57) and slide the drive shaft out.

Inspection

1. Check the gear teeth for chipped, cracked, or missing teeth.
2. Check both ball bearings for wear or pitting.
3. Check condition of rubber damper.
4. If there is any wear or damage, take the drive shaft to your dealer for repairs. Disassembly requires a press as the spring is under considerable tension.

WARNING

Improvised tools could be very dangerous.

Installation

1. Insert drive shaft into crankcase.
2. Align cover with dowel pin, and secure it

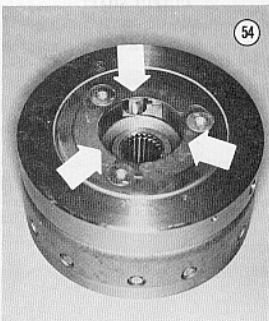

with 4 bolts. Leave the lower left-hand bolt out for now.

3. Slide the starter drive gear and chain onto the drive shaft.

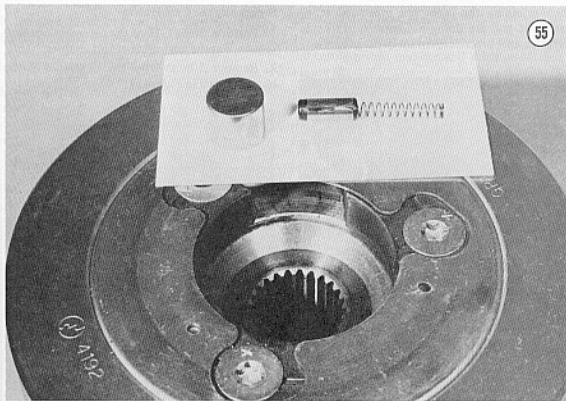

55

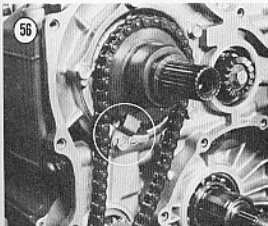

56

4. Install drive gear retainer with remaining cover bolt. See **Figure 56**.

5. Place small starter gear in lower loop of chain. See **Figure 58**.

6. Install starter motor if previously removed.

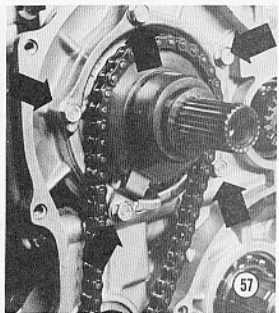

57

CRANKCASE

For some repairs, it may only be necessary to split the cases; complete disassembly may not

be required. Therefore, procedures for splitting the cases and disassembling the internal parts are presented separately. For the same reason, procedures for assembling the internal parts,

then rejoining the cases are presented separately. If you are doing a complete overhaul, perform all 4 procedures in the order presented.

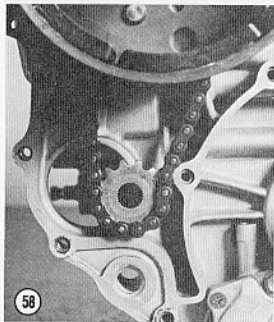

Separating the Case Halves

1. Perform Steps 1-19 of the *General Overhaul* sequence at the beginning of this chapter.
2. Remove 3 bolts from the right side of the engine shown in Figure 59.

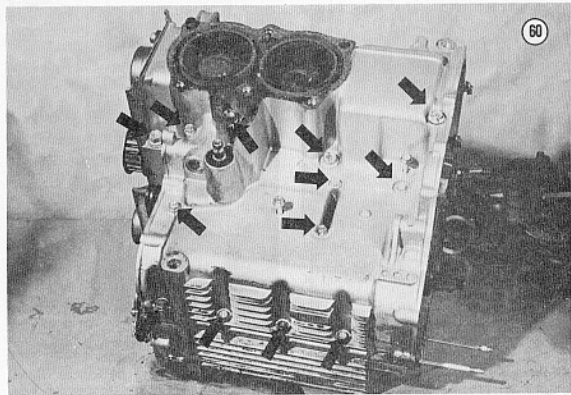
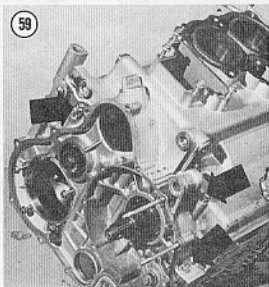

3. Remove 19 bolts from the left side of the engine shown in **Figures 60 and 61**.

4. Lay engine on its right side.

5. Pull the left half off. It is usually necessary to pry them apart; do it very carefully so that you do not mar the gasket surfaces. If you do, the cases will leak and must be replaced.

Disassembling the Crankcase

1. Scratch the tops of the pistons with marks indicating piston number and orientation. See **Figure 62**.

2. Split the crankcase as described elsewhere.

3. Mark each of the main bearing caps so that they can be reinstalled in the same position. See **Figure 63**.

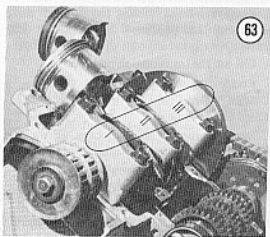
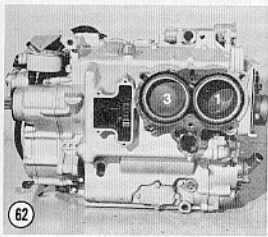
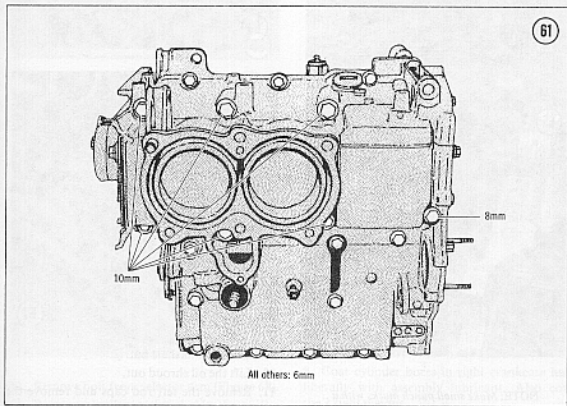

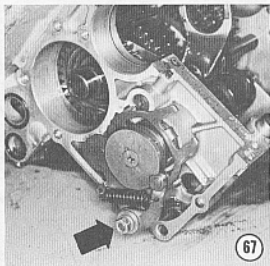
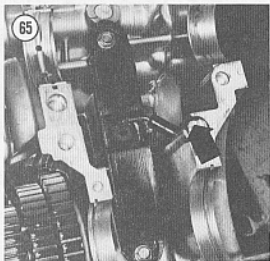
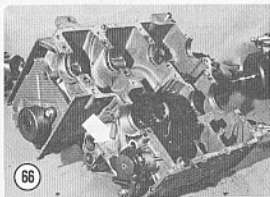
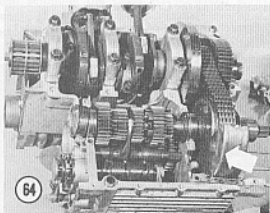

NOTE: Make small punch marks with a screwdriver or punch.

4. Remove 3 bolts holding the primary chain oil shroud. Leave shroud in place. See Figure 64.
5. Lift out the transmission main shaft.
6. Remove main bearing caps.
7. Mark all rod caps so that they can be installed on the same rod.
8. Remove the right rod caps. Push the connecting rods down into the bore until they are free of the crankshaft.

CAUTION

Do not nick the crankshaft journal with the rod. Wrap masking tape over the rod studs to protect the journals.

9. Lift the crankshaft out.
 10. Lift the oil shroud out.
 11. Remove the left rod caps and remove the rods from the crankshaft.
 12. Remove main bearing inserts. Mark their position (case 1, 2, 3; cap 1, 2, 3) on the back so that they can be reinstalled later if in good condition.
 13. Push the right piston/rods completely out of the bores.
 14. Lift out primary chain oiler. See Figure 65.
- NOTE:** The following steps are to remove transmission parts from the case.
15. Remove countershaft bearing caps. See Figure 66.
 16. Remove nut securing selector stops and remove the stops. See Figure 67.

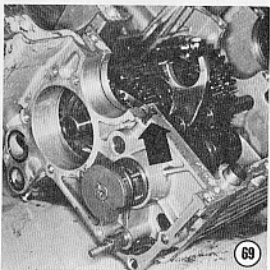
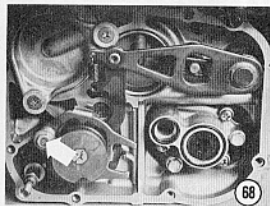

17. Remove bolt from selector arm (Figure 68).
18. Remove small pin that holds the shifter fork shaft and pull the shaft out. See Figure 69.
19. Lift the forks out. Slide them back on the shaft to keep them together. Slide front gear off countershaft. Pull shaft forward and lift countershaft with gears out of the case.
20. Remove bolt securing neutral switch on the outside of the crankcase. See Figure 70. Remove switch and slide shifter drum out.

Assembling the Crankcase

1. Install shifter drum and secure with neutral switch. See Figure 70.
2. Install countershaft without top gear.
3. Slide top gear onto countershaft through hole in case.

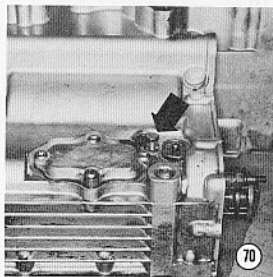

NOTE: The assembly to this point looks like Figure 71.

4. Install countershaft bearing cap and secure with 2 screws. See Figure 66. Tighten screws with an impact driver. Make sure that countershaft rotates freely.
5. Lay shifter forks in place without the shaft. Figure 72 shows orientation of each fork.
6. Slide the shifter fork shaft into place and secure with pin. See Figure 69.
7. Install primary chain oiler and make sure that it is oriented as shown in Figure 73.
8. Coat cylinder bores in right crankcase half liberally with assembly lubricant. Also coat the 2 right pistons.
9. Insert right pistons from the outside into the same bores from which they were removed. Compress the rings from the outside and lightly tap the pistons fully into the bores with a plastic mallet. See Figure 74.

NOTE: If you do not have a ring compressor, use a No. 38 or larger hose clamp. Install the clamp around the rings, and tighten the clamp just enough to compress them. Push the piston. If the clamp is too tight, it may score the rings and piston.

10. Install bearing inserts in left connecting rods and rod caps.

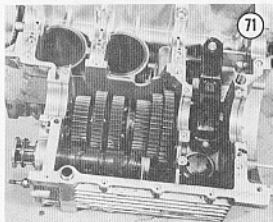

11. Coat left rod bearings and corresponding crankshaft journals liberally with assembly lubricant.

12. Install left piston/rod assemblies on crankshaft. Install in original position and orientation as indicated by marks scratched on top. Tighten rod nuts to 18-21 ft.-lb. (2.5-2.9 mkg).

13. Install main bearing inserts in case. See Figure 75. If reusing the old bearings, make sure that they are installed in the same location.

14. Coat main bearings and crankshaft journals liberally with assembly lubricant.

15. Slide primary chain over crankshaft and over the primary driven gear.

16. Install crankshaft and primary driven gear in right crankcase.

17. Slide transmission main shaft through primary driven gear. Engage main shaft with shifter fork and set main shaft into place.

18. Place a shop rag over the main shaft and lay the 2 exposed pistons on the rag to protect them.

19. Rotate crankshaft as necessary to align and connect right connecting rods to crankshaft. Coat connecting rod bearings and crankshaft journals with assembly lubricant, install rod caps, and tighten to 18-21 ft.-lb. (2.5-2.9 mkg).

20. Install main bearing inserts in bearing caps. If reusing old bearings, make sure that they are installed in the same location.

21. Coat main bearings and crankshaft journals with assembly lubricant and install main

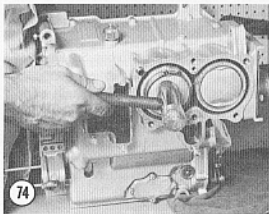
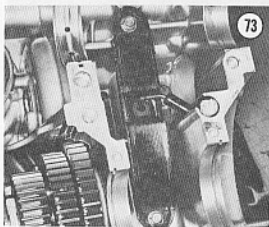
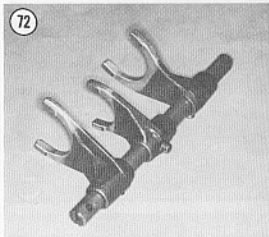

bearing caps in their original locations. Tighten bolts to 24-27 ft.-lb. (3.3-3.7 mkg).

22. Install primary chain oil shroud.

23. Install front main shaft seal. Make sure

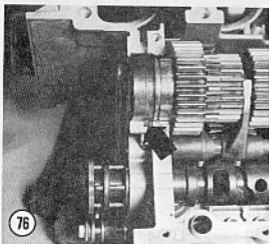
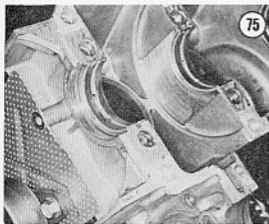

that tab on seal fits in crankcase recess (Figure 76).

24. Install locating dowel on top of right crankcase half and slide O-ring over it. See Figure 77.

Joining the Case Halves

This procedure assumes that all components have been installed in the right crankcase half as described under *Assembling the Crankcase*.

1. Make sure case half sealing surfaces are perfectly clean and dry.
2. Apply a light coat of gasket sealer to the sealing surfaces of both halves. Cover only flat surfaces, not curved bearing surfaces. Make the coating as thin as possible or the cases can shift and hammer out bearings.

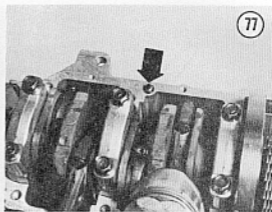

NOTE: Use Gsgacinch, Part No. 440-P, or equivalent. When selecting an equivalent, avoid thick and hardening materials.

3. Lubricate left cylinder bores and pistons liberally with assembly lubricant.
4. Rotate the crankshaft very carefully until either left piston is out as far as it can go.
5. Hold the left case over the right and guide the piston referred to in Step 4 into its bore. Compress the rings and carefully slide the case down.
6. As soon as possible, guide the other piston into its bore and push the case down until it seats squarely with the right case.
7. Install 6 bolts with 10mm shanks shown in Figures 78 and 79. Tighten these bolts snugly, then torque to 24-27 ft.-lb. (3.3-3.7 mkg) working from the center outward.
8. Rotate the crankshaft carefully to make sure everything turns freely. If there is any binding, stop, disassemble the case and find the cause.
9. Install remaining bolts shown in Figures 78, 79, and 80. Tighten to values indicated in Figure 81.

PISTONS AND CONNECTING RODS

The crankcase must be split to reach these parts.

Removal

1. Remove cylinder heads as described under *Cylinder Head Removal*.

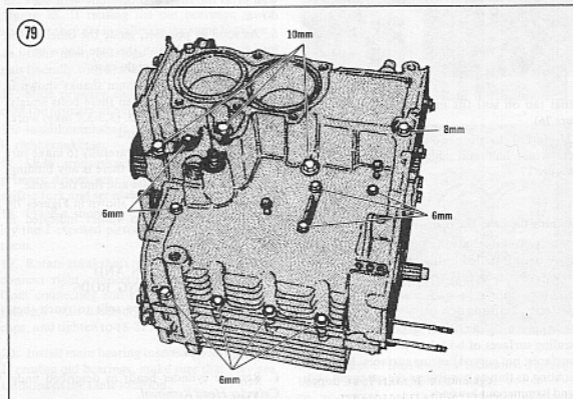
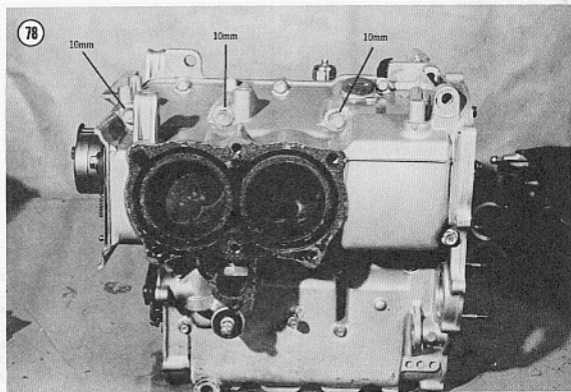

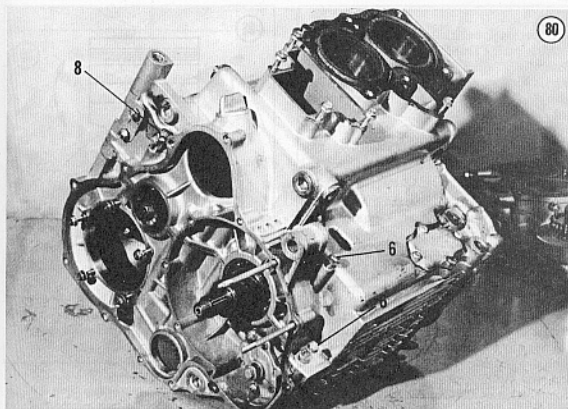

4

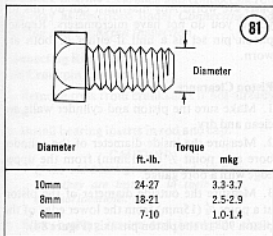

2. Scratch the cylinder number on the top of each piston so that it can be installed in exactly the same place (Figure 62).

3. Rotate the crankshaft until one right bank piston is at the bottom of travel. Place an oil-soaked cloth over the piston to collect cuttings, then remove ridge and/or deposits from upper edge of cylinder bore with a ridge remover.

4. Turn crankshaft until piston is at top of its stroke; remove cloth and cuttings.

5. Repeat for other right bank piston.

6. Split crankcase as described under *Separating Case Halves*.

7. Mark rod caps for the 2 right-hand rods. Remove the caps and push the piston/rod assemblies out of the right crankcase half.

8. Mark rod caps for the 2 left-hand rods. Remove the caps and remove the piston/rod assemblies from the crankshaft.

9. Remove bearing inserts from connecting rods and bearing caps. Mark backs of bearings with cylinder number from which they were removed and whether they were upper or lower bearings.

CAUTION

Bearing inserts may be reused if they are in good condition, but they must be re-installed in their original positions.

Disassembly

1. Remove the rings with a ring expander tool. See Figure 82.

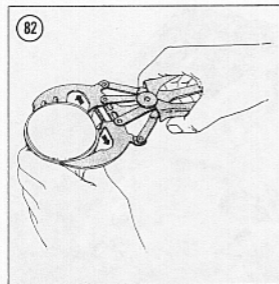

2. Before removing the piston pin, hold the rod tightly and rock the piston as shown in Figure 83. Any rocking movement (do not confuse with sliding motion) indicates wear in the piston pin, rod bushing, pin bore, or more likely, a combination of all three. Mark the piston, pin, and rod for further examination later.

3. Heat the piston and pin with a small butane torch. The piston pin will probably drop right out, but may need coaxing with a brass rod. Heat the piston to about 140°F (60°C), i.e., until it is too warm to touch, but not excessively hot.

Piston Inspection

1. Clean pistons thoroughly in solvent. Scrape carbon deposits from the top of the piston and ring grooves. Do not damage the pistons.

CAUTION

Do not wire brush piston skirts.

2. Examine each ring groove for burrs, dented edges, and side wear. Pay particular attention to the top compression ring groove, as it usually wears more than the others.

3. Measure piston-to-cylinder clearance as described under *Piston Clearance* procedure below.

4. If damage or wear indicates piston replacement, select a new piston as described under *Piston Clearance* procedure.

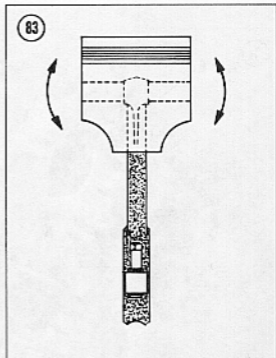

5. Measure any parts marked in Step 2 of the *Disassembly* procedure with a micrometer and dial bore gauge to determine which part or parts are worn. Any machinist can do this for you if you do not have micrometers. Replace piston/pin set as a unit if either or both are worn.

Piston Clearance

1. Make sure the piston and cylinder walls are clean and dry.

2. Measure the inside diameter of the cylinder bore at a point $\frac{1}{8}$ in. (13mm) from the upper edge with a bore gauge.

3. Measure the outside diameter of the piston at a point $\frac{1}{8}$ in. (15mm) from the lower edge of the piston 90° to the piston pin axis (Figure 84).

4. If difference in 2 readings exceeds 0.004 in. (0.10mm), replace the piston. New parts have a difference of 0.0008 in. (0.02mm).

Connecting Rod Inspection

1. Check each rod for obvious damage such as cracks and burns.

2. Check the piston pin bushing for wear or scoring.

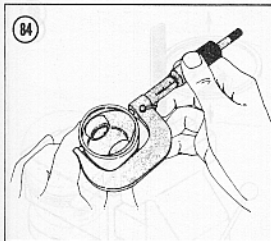

3. Take the rods to machine shop and have them check alignment for twisting and bending.
4. Examine the bearing inserts for wear, scoring, or burning. They are reusable if in good condition. Make a note of the bearing size (if any) stamped on the back of the insert if the bearing is to be discarded; a previous owner may have used undersize bearings.
5. Check bearing clearance and connecting rod side play as described under *Connecting Rod Bearing and Crankpin Inspection*.

Connecting Rod Bearing and Crankpin Inspection

1. Remove rods from crankshaft if not already done.
2. Install bearing inserts in rod and cap.

CAUTION

If the old bearings are reused, be sure that they are installed in their exact original locations.

3. Wipe bearing inserts and crankpins clean. Check again that inserts and crankpins are in good condition.
4. Place a piece of Plastigage on one crankpin parallel to the crankshaft.
5. Install rod cap and tighten nuts to 18-21 ft.-lb. (2.5-2.9 mkg).

CAUTION

Do not rotate crankshaft while Plastigage is in place.

6. Remove rod cap.

7. Measure width of flattened Plastigage according to the manufacturer's instructions. Measure at both ends of the strip. A difference of 0.001 in. (0.025mm) or more indicates a tapered crankpin. Bearing clearance for a new bearing should measure 0.0008-0.0017 in. (0.020-0.044mm). Used bearing clearance must not exceed 0.003 in. (0.08mm).

8. Remove Plastigage strip.

9. Repeat Steps 4-8 for each of the other rods.

10. Lubricate bearings and crankpins and install rod caps. Tighten the nuts to 18-21 ft.-lb. (2.5-2.9 mkg).

11. Rotate crankshaft to be sure bearings are not too tight.

12. Insert feeler gauge between connecting rods. Axial clearance should be less than 0.016 in. (0.4mm). Replace any rods with excessive side clearance.

13. Remove the connecting rods.

Assembly

1. Coat the connecting rod bushing, piston pin, and piston holes with assembly lubricant.

2. Place the piston over the connecting rod. If you are reusing the same pistons and connecting rods, match the pistons to the rod from which it came and orient it in the same way. If either a piston or its rod is new, orientation is not important; the pistons are symmetrical.

3. Insert the piston pin and tap it with a plastic mallet until it starts into the connecting rod bushing. If it does not slide in easily, heat the piston until it is too warm to touch but not excessively hot (140°F or 60°C). Continue to drive the piston pin in while holding the piston so that the rod does not have to take any shock. Otherwise, it may be bent. Drive the pin in until it is centered in the rod.

4. Install rings as described in Steps 3-8 under *Piston Ring Replacement*.

5. Insert bearing shells in connecting rod in the bearing cap with the locating tangs locked into place.

CAUTION

If old bearings are reused, be sure they are installed in their exact original locations.

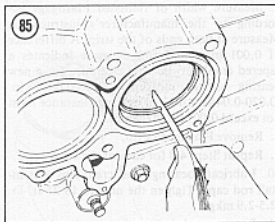

PISTON RINGS

Replacement

1. Remove old rings with a ring expander tool. See Figure 82.
2. Carefully remove all carbon from the ring grooves. Inspect grooves carefully for burrs, nicks, or broken and cracked lands. Recondition or replace piston if necessary.
3. Check end gap of each ring. To check ring, insert it in the cylinder bore and square it with the wall by tapping with the piston. The ring should be in about $\frac{1}{16}$ in. (1.5mm). Insert a feeler gauge as shown in Figure 85. Compare gap with Table 1. If the gap is smaller than specified, hold a small file in a vise, grip the ends of the ring with your fingers, and enlarge the gap. See Figure 86.
4. Roll each ring around its piston groove as shown in Figure 87 to check for binding. Minor binding may be cleaned up with a fine cut file.
5. Install oil ring in oil ring groove with a ring expander tool.
6. Install 2 compression rings carefully with a ring expander tool.
7. Check side clearance of each ring as shown in Figure 88. Compare with specifications in Table 1.
8. Distribute ring gaps around piston as shown in Figure 89.

CRANKSHAFT

The crankcase must be disassembled to remove the crankshaft.

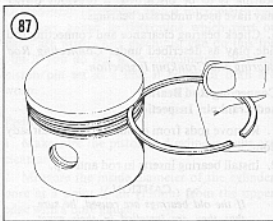
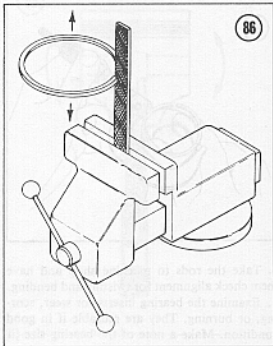

Removal

1. Split the crankcase as described under *Separating the Case Halves*.
2. Perform Steps 1-11 under *Disassembling the Crankcase* to remove the crankshaft.
3. Install by assembling the crankcase.

Crankshaft Inspection

1. Clean crankshaft thoroughly with solvent. Clean oil holes with rifle cleaning brushes; flush thoroughly and blow dry with air. Lightly oil all journal surfaces immediately to prevent rust.

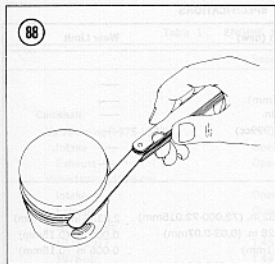

2. Carefully inspect each journal for scratches, ridges, scoring, nicks, etc. Very small nicks and scratches may be removed with crocus cloth. More serious damage must be removed by grinding, a job for a machine shop.

3. If the surface finish on all journals is satisfactory, take the crankshaft to your dealer or local machine shop. They can check out-of-roundness, taper, and wear on the journals. They can also check crankshaft alignment and inspect for cracks.

Main Bearing and Journal Inspection

1. Check each main bearing insert for evidence of wear, abrasion, and scoring. If the bearings are good, they may be reused. If any insert is questionable, replace the entire set.

2. Install bearing inserts in the right case half and caps.

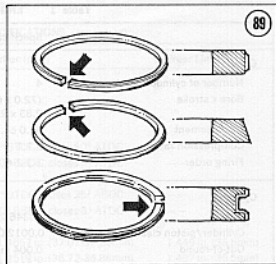

3. Set crankshaft in place.

4. Place a piece of Plastigage over each main bearing journal parallel to the crankshaft.

5. Install main bearing caps and tighten retaining bolts evenly to 24-27 ft.-lb. (3.3-3.7 mkg).

CAUTION

Do not rotate the crankshaft while the Plastigage is in place.

6. Remove the bearing caps.

7. Measure the width of the flattened Plastigage according to manufacturer's instructions. Measure at both ends of Plastigage strip. A difference of 0.001 in. or more indicates a tapered journal. Confirm with a micrometer. Bearing clearance for new bearings should be 0.0008-0.0017 in. (0.02-0.044 mm). Used bearing clearance must not exceed 0.003 in. (0.08 mm).

8. Remove Plastigage strips.

Table 1 ENGINE SPECIFICATIONS

	Specification (new)	Wear Limit
General		
Number of cylinders	4	—
Bore x stroke	(72.0 x 61.4mm) 2.83 x 2.42 in.	—
Displacement	61.0 cu. in. (999cc)	—
Compression ratio	9.2:1	—
Firing order	1-3-2-4	—
Cylinders		
Bore	2.8346-2.8352 in. (72.000-72.015mm)	2.8385 in. (72.1mm)
Cylinder/piston clearance	0.0012-0.0028 in. (0.03-0.07mm)	0.006 in. (0.15mm)
Out-of-round	0.004 in. (0.1mm)	0.006 in. (0.15mm)
Taper	0.0003-0.0005 in. (0.007-0.012mm)	0.002 in. (0.05mm)
Pistons		
Diameter at skirt	2.8325-2.8335 in. (71.945-71.970mm)	2.8288 in. (71.85mm)
Clearance in bore	0.0012-0.0028 in. (0.03-0.07mm)	0.006 in. (0.15mm)
Oversizes available	0.25-1.00mm (0.25mm steps)	—
Ring groove width		
Compression	0.059-0.060 in. (1.51-1.52mm)	0.063 in. (1.6mm)
Oil control	0.110-0.111 in. (2.805-2.820mm)	0.114 in. (2.9mm)
Piston Rings		
Number per piston		
Compression	2	—
Oil control	1	—
Ring end gap		
Compression	0.010-0.016 in. (0.25-0.40mm)	0.03 in. (0.7mm)
Oil control	0.008-0.035 in. (0.20-0.90mm)	0.04 in. (1.10mm)
Ring side clearance		
Compression	0.0008-0.0018 in. (0.02-0.045mm)	0.006 in. (0.15mm)
Crankshaft		
Main bearing journal diameter	1.889-1.890 in. (48.000-48.024mm)	—
Main bearing out-of-round	—	0.0011 in. (0.03mm)
Connecting rod journal diameter	1.575-1.576 in. (40.000-40.024mm)	—
Connecting rod journal out-of-round	—	0.0011 in. (0.03mm)
Main bearing clearance	0.0008-0.0017 in. (0.02-0.044mm)	0.003 in. (0.08mm)
Connecting Rods		
Side clearance	0.006-0.012 in. (0.15-0.30mm)	0.016 in. (0.40mm)
Bearing clearance	0.0008-0.0017 in. (0.02-0.044mm)	0.003 in. (0.08mm)

(continued)

Table 1 ENGINE SPECIFICATIONS

	Specification (new)	Wear Limit
General		
Number of cylinders	4	—
Bore x stroke	(72.0 x 61.4mm) 2.83 x 2.42 in.	—
Displacement	61.0 cu. in. (999cc)	—
Compression ratio	9.2:1	—
Firing order	1-3-2-4	—
Cylinders		
Bore	2.8346-2.8352 in. (72.000-72.015mm)	2.8385 in. (72.1mm)
Cylinder/piston clearance	0.0012-0.0028 in. (0.03-0.07mm)	0.006 in. (0.15mm)
Out-of-round	0.004 in. (0.1mm)	0.006 in. (0.15mm)
Taper	0.0003-0.0005 in. (0.007-0.012mm)	0.002 in. (0.05mm)
Pistons		
Diameter at skirt	2.8325-2.8335 in. (71.945-71.970mm)	2.8288 in. (71.85mm)
Clearance in bore	0.0012-0.0028 in. (0.03-0.07mm)	0.006 in. (0.15mm)
Oversizes available	0.25-1.00mm (0.25mm steps)	—
Ring groove width		
Compression	0.059-0.060 in. (1.51-1.52mm)	0.063 in. (1.6mm)
Oil control	0.110-0.111 in. (2.805-2.820mm)	0.114 in. (2.9mm)
Piston Rings		
Number per piston		
Compression	2	—
Oil control	1	—
Ring end gap		
Compression	0.010-0.016 in. (0.25-0.40mm)	0.03 in. (0.7mm)
Oil control	0.008-0.035 in. (0.20-0.90mm)	0.04 in. (1.10mm)
Ring side clearance		
Compression	0.0008-0.0018 in. (0.02-0.045mm)	0.006 in. (0.15mm)
Crankshaft		
Main bearing journal diameter	1.889-1.890 in. (48.000-48.024mm)	—
Main bearing out-of-round	—	0.0011 in. (0.03mm)
Connecting rod journal diameter	1.575-1.576 in. (40.000-40.024mm)	—
Connecting rod journal out-of-round	—	0.0011 in. (0.03mm)
Main bearing clearance	0.0008-0.0017 in. (0.02-0.044mm)	0.003 in. (0.08mm)
Connecting Rods		
Side clearance	0.006-0.012 in. (0.15-0.30mm)	0.016 in. (0.40mm)
Bearing clearance	0.0008-0.0017 in. (0.02-0.044mm)	0.003 in. (0.08mm)

(continued)

NOTE: If you own a 1980 or later model, first check the Supplement at the back of the book for any new service information.

CHAPTER FIVE

CLUTCH AND TRANSMISSION

CLUTCH

All clutch parts except for the clutch housing can be removed with the engine in the frame, but space is very limited. **Figure 1** shows an exploded view of the clutch. **Table 1** provides specifications for the clutch.

Clutch Cable Replacement

1. Remove 2 screws securing clutch cable cover, and remove cover.
2. Disconnect bottom end of the clutch cable from operating lever, and pull cable end free.
3. Disconnect top end of clutch cable from hand lever. See **Figure 2**. Loosen adjuster, if necessary.
4. Note routing of cable through frame, then pull cable out.
5. Install new cable following the old routing.
6. Reconnect cable ends, and install clutch cover.
7. Adjust clutch free play as described in Chapter Three.

Removal

NOTE: The first 2 steps apply only if the engine is in the frame.

1. Remove rear wheel as described in Chapter Ten, and muffler as described in Chapter Six.

2. Remove clutch cable cover and disconnect clutch cable at engine.

3. Remove 8 Phillips screws securing the clutch cover, and lift the cover off. See **Figure 3**.

4. Remove clutch lifter piece from lifter.

5. Remove 6 bolts holding the clutch lifter plate. See **Figure 4**.

6. Remove lifter plate and pull out springs.

7. Bend down lockwasher tab and remove clutch locknut with special tool 86-28301. See **Figure 5**. Remove the lockwasher and flat washer. See **Figure 6**.

8. Pull clutch center, discs, and pressure plate out of the clutch housing.

NOTE: The clutch housing cannot be removed without first removing the engine and the rear cover. See Chapter Four for procedures.

9. Slide splined spacer off transmission main shaft.

Disassembly/Assembly

1. Lift pressure plate off clutch assembly. See **Figure 7**.

2. Slide all clutch plates and friction discs off the clutch center.

CLUTCH

1. Clutch housing
2. Pressure plate
3. Friction disc
4. Laminated damper plate
5. Metal clutch plate
6. Friction disc
7. Spined washer
8. Clutch center
9. Bolt
10. Clutch spring
11. Washer
12. Lockwasher
13. Locknut
14. Lifter plate
15. Bearing
16. Lifter
17. Circlip

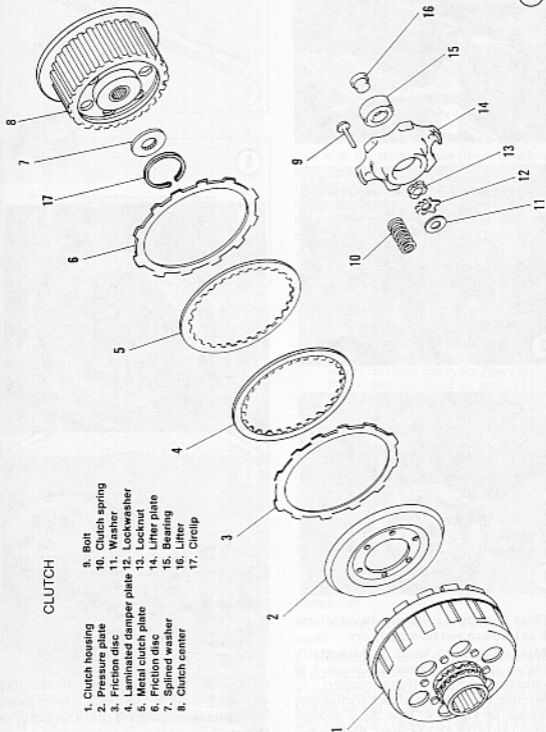

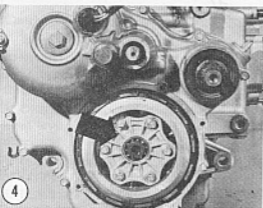
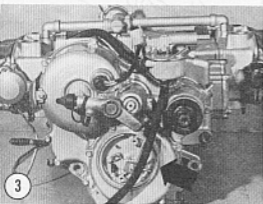
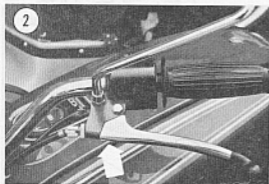

3. Clean all parts in petroleum-based solvent such as kerosene and thoroughly dry.

4. Measure the free length of each clutch spring as shown in Figure 8. Compare to specifications in Table 1 (end of chapter).

5. Measure the thickness of each friction disc as shown in Figure 9. New discs measure 0.135-0.141 in. (3.42-3.58 mm). Replace any discs that are less than 0.125 in. (3.2 mm) or worn unevenly.

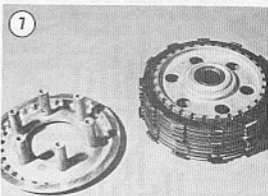
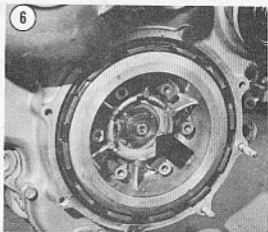
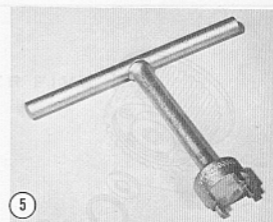

6. Measure the backlash between friction discs and clutch outer housing with a feeler gauge. See Figure 10. Replace any disc if the gap is too large.

7. Check all other parts for signs of wear or other damage. Replace suspect parts.

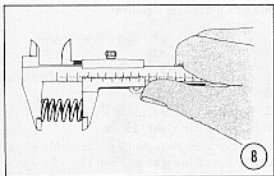

8. Lay the clutch center on a flat surface.

NOTE

If either or both friction discs and clutch plates have been replaced with new ones, apply new engine oil to all surfaces to avoid having the clutch lock up when used for the first time.

NOTE

Install the friction discs with the oil slinger grooves radiating counterclockwise as shown in Figure 11.

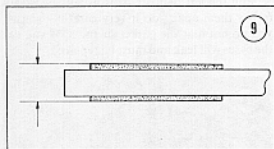

9. Onto the clutch center, install the friction disc with the thickest tabs (there is only one with thick tabs).

10. Next install a clutch plate followed by a friction disc. Continue to install a clutch plate, then a friction disc until 4 friction discs and 3 clutch plates are installed. See Figure 11.

11. Install the laminated damper plate (4, Figure 1) with the toothed side facing down toward the already installed friction discs and clutch plates. See Figure 12.

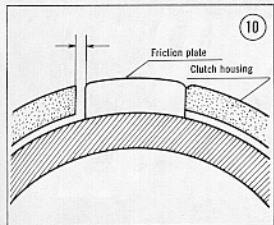

NOTE

Some early models were assembled with the laminated damper plate (4, Figure 1) next to the clutch center. See Figure 13. This causes the clutch to grab. The laminated damper plate should be assembled in the middle of the stack on all models. See Figure 14.

12. Install a friction disc followed by a clutch plate. Continue to install a friction disc, then a clutch plate until there are an additional 4 friction discs and 3 clutch plates installed. There is now a total of 8 friction discs and 6 clutch plates installed.

13. Install pressure plate onto this assembly.

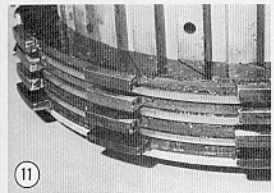

Installation

1. Install splined spacer on transmission main shaft.
2. Install clutch center, discs and pressure plate in the clutch housing as a single assembly.
3. Install flat washer, lockwasher, and clutch locknut on end of main shaft. Tighten locknut with special tool shown in Figure 5 to 27-30 ft.-lb. (3.8-4.2 mkg).

4. Slide springs onto bosses in clutch center.
5. Slide clutch lifter plate into place and secure with 6 bolts. See **Figure 4**. Tighten diagonally opposite bolts a little at a time until snug. Torque diagonally opposite bolts to 7-10 ft.-lb. (1.0-1.4 mkg).
6. Fit clutch lifter piece in end of lifter.
7. Install clutch cover with 8 screws.
8. Connect clutch cable and install clutch cable cover.
9. Adjust clutch as described in Chapter Three.

TRANSMISSION

The engine crankcase must be split to repair any transmission components. **Tables 2 and 3** provide transmission specifications.

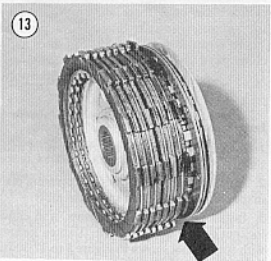
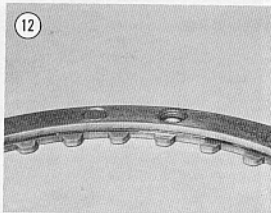

Major Component Removal

NOTE: The first 5 steps describe splitting the crankcase.

1. Perform Steps 1-19 of the *General Overhaul Sequence* in Chapter Four.
2. Remove 3 bolts from the right side of the engine shown in **Figure 15**.
3. Remove 19 bolts from the left side of the engine shown in **Figures 16 and 17**.
4. Lay the engine on its right side.
5. Pull the left half off. It is usually necessary to pry them apart; do it very carefully so that you do not mar the gasket surfaces. If you do, the cases will leak and must be replaced.

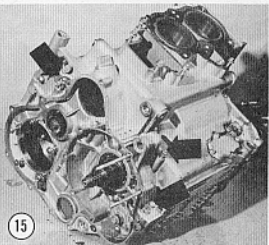
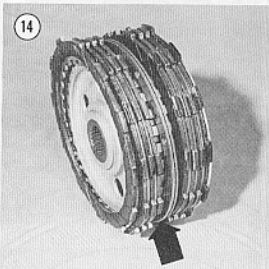

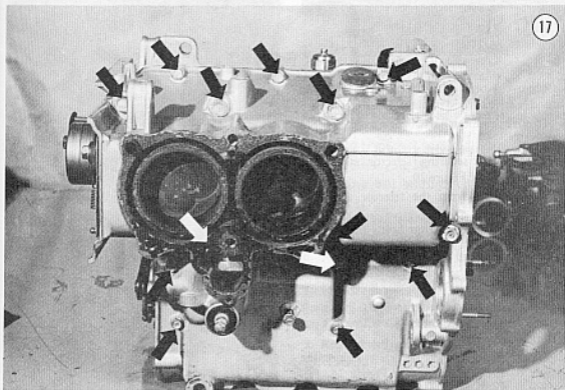
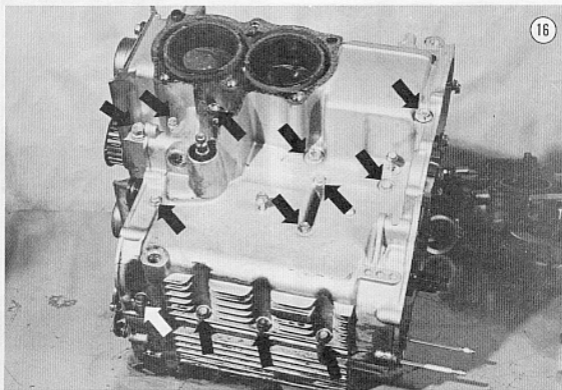

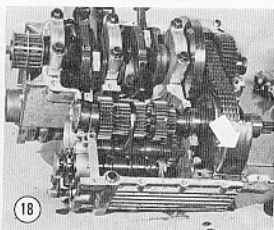

18

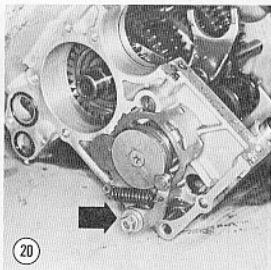

20

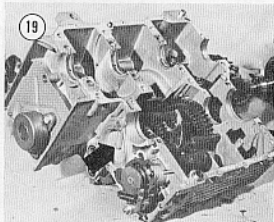

19

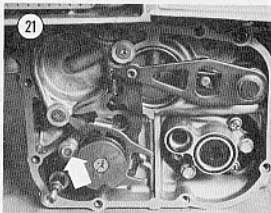

21

6. Remove 3 bolts holding the primary chain shroud. Leave shroud in place. See **Figure 18**.

7. Remove countershaft bearing cover. See **Figure 19**.

8. Remove nut securing selector stops and remove stops. See **Figure 20**.

9. Remove bolt from the selector arm. See **Figure 21**.

10. Remove small pin that holds the selector fork shaft and pull the shaft out. See **Figure 22**.

11. Lift the forks out. Slide them back on the shaft to keep them together. See **Figure 23**.

12. Slide front gear off countershaft. Pull shaft forward and lift the countershaft with gears out of the case.

13. Remove bolt securing neutral switch on the outside of the crankcase. See **Figure 24**. Remove switch and slide shifter drum out.

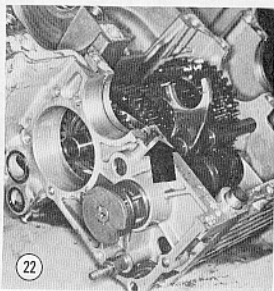

22



23

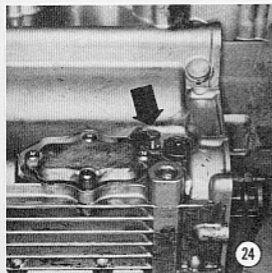

24

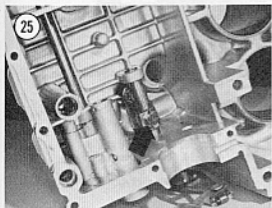

25

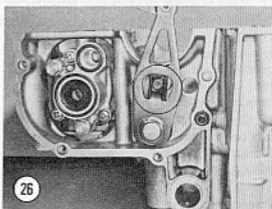

26

Gearshift Linkage in Crankcase

The crankcase must be split to remove these parts from the left crankcase half.

1. Bend down the lock tab shown in **Figure 25**, and remove the bolt.
2. Slide off gearshift arm.
3. Slide off return spring.
4. Remove gearshift spindle.
5. Assembly is the reverse of these steps. Make sure that the return spring ends engage on each side of the spring pin. See **Figure 26**. Make sure that the arm engages with the spindle.

Main Shaft Disassembly/Assembly

Refer to **Figure 27** for this procedure.

1. Remove splined thrust washer if not already removed.
2. Slide off primary driven sprocket and thrust washer. See **Figure 28**.
3. Remove ball bearings on sprocket end of shaft.
4. Remove ball bearing from other end.
5. Remove thrust washer.
6. Remove 5th gear and brass bushing. Also remove the splined thrust washer.
7. Remove snap ring and 2nd/3rd gear.
8. Remove remaining snap ring and splined washer.
9. Remove 4th gear.
10. Clean all parts in solvent.
11. Check each gear for excessive wear, chipped or missing teeth. Make sure that lugs on ends of gears are in good condition.

12. Make sure that all gears slide smoothly on the main shaft splines.

13. Check needle bearings in the primary driven sprocket. Make sure that they operate smoothly, and show no signs of wear or damage. If replacement is necessary, take the sprocket to your dealer.

14. Check the 2 ball bearings. Make sure that they operate smoothly with no signs of wear or damage.

15. Assembly is the reverse of these steps.

Transmission Countershaft Disassembly/Assembly

Refer to Figures 29 and 30 for this procedure.

1. Slide off 5th gear and final drive gear.
2. Slide off the 1st gear with its brass bushing.
3. Slide off thrust washer.

4. Remove snap ring next to 2nd gear. Slide off thrust washer and 2nd gear.

5. Remove snap ring next to 4th gear. Slide off 4th gear.

6. Remove snap ring securing 3rd gear. Slide off thrust washer and 3rd gear.

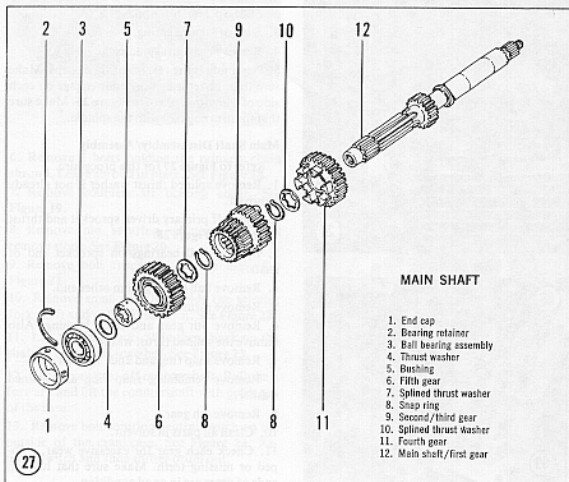
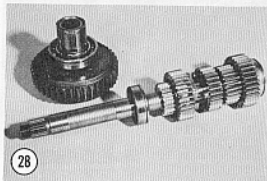

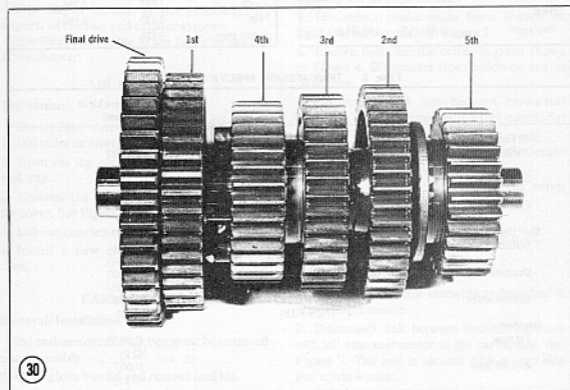
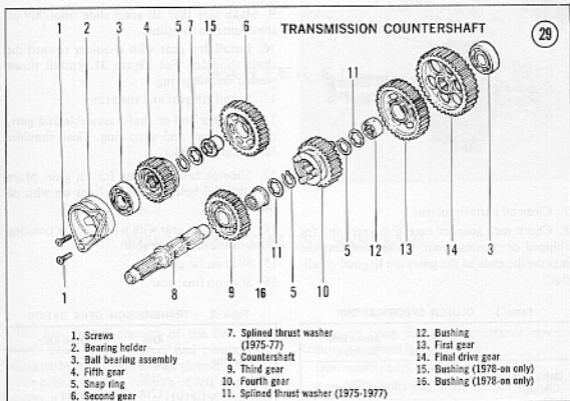

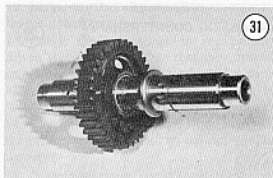

7. Clean all parts in solvent.

8. Check each gear for excessive wear, and for chipped or missing teeth. Make sure that the lugs on the ends of the gears are in good condition.

9. Make sure that all gears slide smoothly on the countershaft splines.

10. Install 3rd gear with shoulder toward the shaft shoulder. See Figure 31. Install thrust washer and snap ring.

11. Install 4th gear and snap ring.

12. On other end of shaft, assemble 2nd gear, thrust washer, and snap ring. Gear shoulder faces shaft shoulder.

13. Slide on brass bushing for 1st gear. Make sure that oil hole in bushing lines up with oil hole in shaft.

14. Slide on 1st gear with widest collar pointing towards the end of the shaft.

15. Slide on 1st gear.

16. Slide on final gear.

Table 1 CLUTCH SPECIFICATIONS

	New in. (mm)	Service Limit in. (mm)
Clutch discs and plates		
Warpage	—	0.012 (0.3)
Thickness	0.135-0.141 (3.42-3.58)	0.126 (3.2)
Springs		
Free length	1.40 (35.5)	1.35 (34.2)

Table 2 TRANSMISSION GEAR RATIOS

	Ratio	Overall Ratio
Primary drive	1.708	—
First	2.500	11.977
Second	1.708	8.183
Third	1.333	6.388
Fourth	1.097	5.256
Fifth	0.939	4.500
Output gears	0.825	—

Table 3 TRANSMISSION SPECIFICATIONS

	New in. (mm)	Service Limit in. (mm)
Shift Forks		
Shaft bore ID	0.5118-0.5215 (13.000-13.018)	0.5133 (13.040)
Shaft diameter	0.5104-0.5112 (12.966-12.984)	0.5078 (12.900)
End thickness	0.25-0.26 (6.4-6.5)	0.24 (6.1)
Shift Drum		
Outside diameter	1.4157-1.4165 (35.96-35.98)	1.414 (35.92)
Diameter in grooves	0.4711-0.4718 (11.97-11.98)	0.4700 (11.95)
Groove width	0.278-0.282 (7.05-7.15)	0.283 (7.20)
Backlash		
1st gear	—	0.0078 (0.2)
2nd-5th gear	—	0.007 (0.17)

NOTE: If you own a 1980 or later model, first check the Supplement at the back of the book for any new service information.

CHAPTER SIX

FUEL AND EXHAUST SYSTEMS

The fuel system consists of the fuel tank, shutoff petcock, fuel filter, fuel pump, four Keihin carburetors, and one air cleaner.

The exhaust system consists of left and right headers, a U-shaped muffler (1975-1977) or two separate mufflers (1978-on).

This chapter includes service procedures for all parts of the fuel and exhaust systems.

Specifications (Table 1) are found at the end of the chapter.

AIR CLEANER

Replacement

The air filter element must be replaced every 12,000 miles or more frequently in dusty areas.

1. Open the top compartment and remove the tool tray.
2. Unscrew the air filter wing nut and remove the cover. See Figure 1.
3. Lift out the element and discard it.
4. Install a new element by reversing these steps.

CARBURETORS

Removal/Installation

The carburetors and air box must be removed as an assembly.

1. Open glove box lid and remove tool kit.

2. Remove wing nut on air cleaner cover. Remove cover and element.

3. Disconnect spark plug wires.

4. Remove 2 bolts inside air cleaner housing. See Figure 2. Disconnect breather hose. Pull housing out through the top.

5. Disconnect choke cable from linkage on right rear carburetor. See Figure 3.

6. Loosen both throttle cables at point shown in Figure 4. Disconnect from bellcrank at rear of air box.

7. Disconnect fuel line between carburetor assembly and fuel pump at the fuel pump. See Figure 5.

8. Remove 2 acorn bolts at each intake manifold. See Figure 6.

9. Remove 2 screws securing air cut valve; move it aside for clearance.

10. Slide carburetor assembly out.

11. Installation is the reverse of these steps.

Removing Individual Carburetor

1. Remove carburetor assembly as described in previous procedure.

2. Disconnect link between throttle bellcrank and left rear carburetor at the carburetor. See Figure 7. The link is secured with a snap ring and nylon washer.

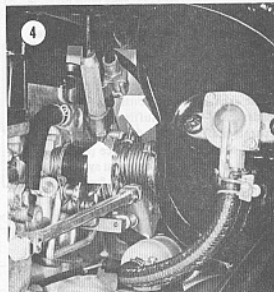
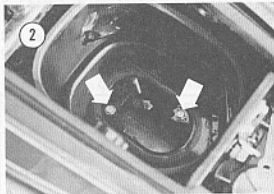
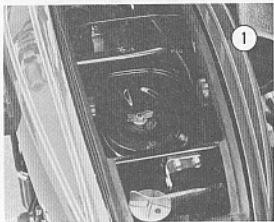

3. Disconnect choke link at left rear carburetor. See **Figure 7**.

4. Remove 5 screws holding left and right halves of air box together.

5. Bend down locking tabs inside air box securing carburetor mounting bolts.

6. Remove 2 bolts securing each carburetor to air box. See **Figure 8**.

7. Remove 2 screws securing each carburetor to its chrome bridge. See **Figure 9**.

8. Disconnect slow air line.

9. Loosen clamp and pull off intake manifold. See **Figure 10**.

10. Installation is the reverse of these steps. Note the following points:

- Make sure that O-rings on end of carburetor flange are in place. See **Figure 11**.
- Bend over locking tabs when mounting bolts are tight.

c. Make sure that universal coupling and small spring shown in **Figure 12** are installed between throttle shafts.

d. Smear the rubber gasket for air box with Vaseline.

e. Note there are 4 short air box screws and one long. The long one goes in the top hole near the air cut valve. See **Figure 13**.

Disassembly/Assembly

- Remove short slow air line from carburetor.

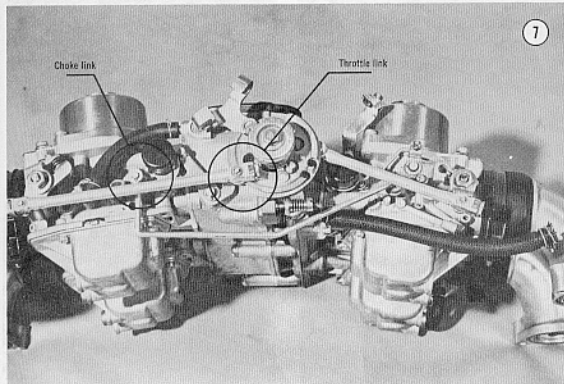
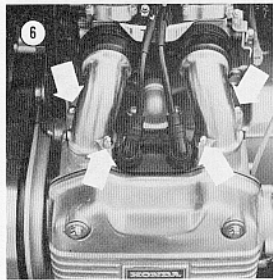
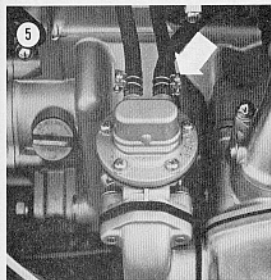

2. Remove 2 screws securing top cover (Figure 14) and remove the cover.
3. Carefully lift out the spring and piston. See Figure 15.

CAUTION

Do not bend the needle in the piston.

4. Lift out plastic seal in carburetor throat.
5. Remove 4 screws securing float bowl to main body. Lift the bowl off. See Figure 16.
6. Drive float pin out carefully from the side opposite the fuel inlet pipe. See Figure 17.
7. Lift the float assembly with the float valve

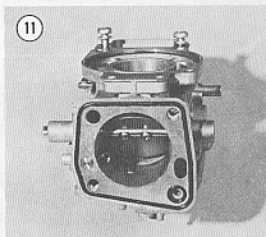
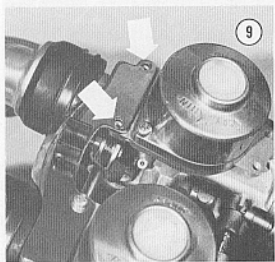
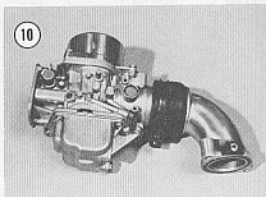
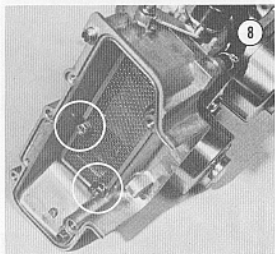

needle out of the main body. Slide the valve needle off the float.

8. Lift off main body gasket.

9. Remove screw and retainer holding the valve seat in main body. See Figure 18. Pull seat out.

10. Pull primary and secondary main jets out of body. To do this, pull up gently on the black clip holding them in place. See Figure 19.

11. Invert body and shake out the small aluminum plug. Also shake out the primary and secondary nozzles. See Figure 20.

12. Remove rubber cap, and unscrew slow fuel jet (Figure 20).

13. Remove Phillips screw inside throat. See Figure 21.

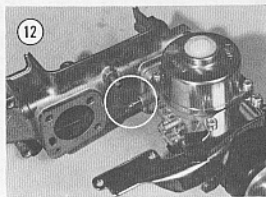

14. Invert body and shake out metal and fiber plates. If necessary, pry them out gently with a screwdriver in the screw hole.

15. Unscrew the secondary air jet and the primary air jet. See Figure 22.

16. Unscrew slow air jet from air cut-off connection. See Figure 23.

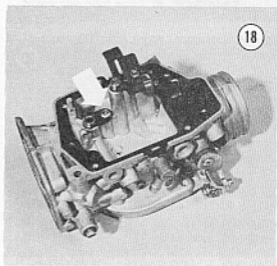
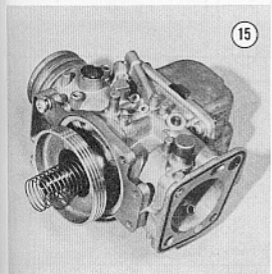
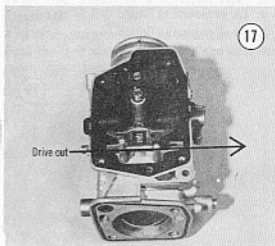
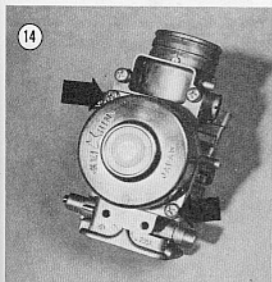
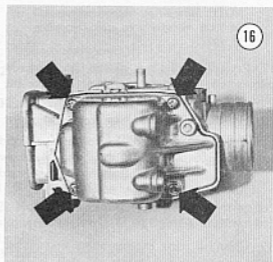
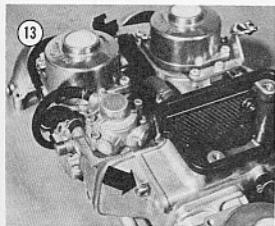

NOTE: Slow air jet cannot be removed on bikes manufactured after December 31, 1977.

17. Pry off small black plastic cap. Unscrew pilot screw (idle mixture valve). Remove the pilot screw and spring.

18. Pry out rubber O-rings from carburetor mounting flange. See Figure 11.

NOTE: Further disassembly is neither necessary nor recommended. If throttle or choke shafts or butterflies are damaged, take the body to your dealer for replacement or repair.

19. Clean all parts except rubber and plastic parts with carburetor cleaner.

20. Purchase the following O-rings:

- a. Large mounting flange
- b. Small mounting flange
- c. Idle mixture needle

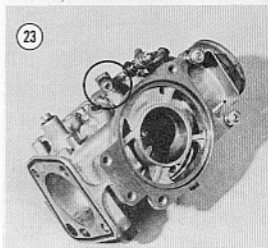
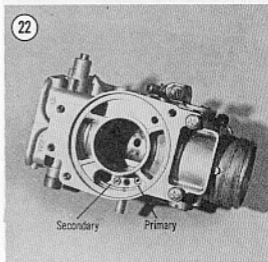
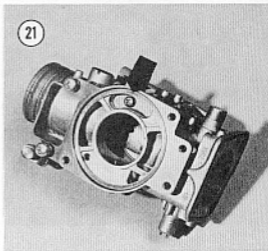
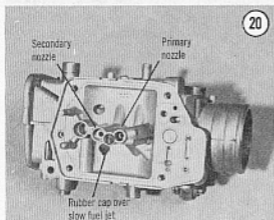
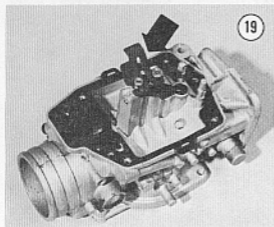
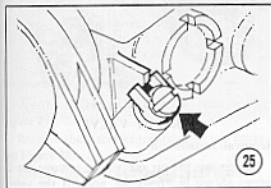
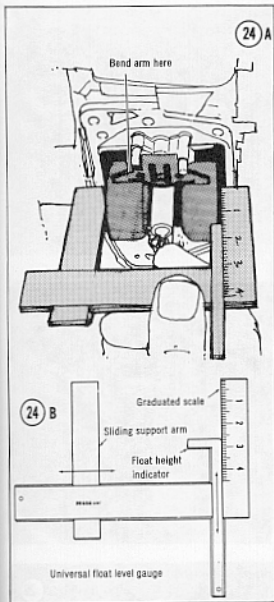

Figure 21

Figure 22

Figure 23



- d. Float valve body
- e. Primary main jet
- f. Secondary main jet

21. Assembly is the reverse of these steps.

Float Level Adjustment

The float level can be adjusted with the carburetors attached to the air box, however, the whole assembly must be removed from the bike. See *Carburetor Removal*.

1. Remove float bowl(s) if not done previously.
2. Hold carburetor so that the pivot is up as shown in Figure 24A. The gasket must not be in place.
3. Measure from the bottom of the float to the surface of the carburetor. Use Honda's special gauge (HC 23892) or a universal type. See Figure 24B.
4. The measurement should be 21mm. If not, bend the tang with needle nose pliers until the measurement is correct.
5. Install the float bowl(s).

Idle Mixture Adjustment (1975-1977)

This adjustment applies only to non-emission controlled GL-1000's manufactured until December 31, 1977. It is not a routine adjustment, and is only necessary if the factory setting is disturbed, such as after a carburetor overhaul.

1. Remove the limiter cap from each carburetor. See Figure 25.
2. Screw the pilot screw in (clockwise) until it seats lightly.
3. Unscrew the pilot screw (counterclockwise) the specified number of turns shown in Table 1 (at the end of the chapter).
4. Install the limiter caps.

Idle Mixture Adjustment (1978-on)

This procedure applies only to emission controlled GL-1000's manufactured since January 1, 1978. It does not apply to earlier models.

Idle mixture adjustment (pilot screw) on these models is not a routine adjustment. It should only be performed if the factory setting is disturbed, such as after a carburetor overhaul.

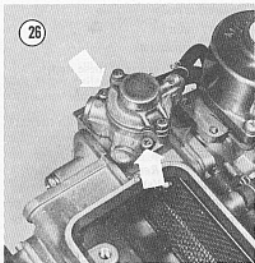

1. Remove limiter caps from pilot screws on each carburetor. See Figure 25.
2. Screw the carburetor pilot screws in clockwise until they lightly seat. Screw them out (counterclockwise) 2 turns.

CAUTION

Take care not to screw the pilot screws in too tightly. This could damage the seats.

3. Synchronize the carburetors as described in Chapter Three, *Carburetor Synchronization*.
4. Adjust the idle speed as described in Chapter Three, *Carburetor Idle Adjustment*.
5. Adjust each pilot screw in turn to gain the highest idle speed. They interact somewhat, so you must repeat the adjustment until no further increase is obtained.
6. Readjust idle speed as described in Chapter Three, *Carburetor Idle Adjustment*.
7. On carburetor No. 1, screw the pilot screw in until the idle speed drops 100 rpm. Then back the screw out (counterclockwise) $\frac{1}{4}$ turn.
8. Readjust idle speed to that specified in Table 1 (end of chapter).
9. Repeat Steps 7 and 8 for the other 3 carburetors.
10. Install the limiter caps on the carburetors. Make sure that the lug on the carburetor body aligns between the lugs on the cap.
11. Readjust carburetor idle speed if necessary.

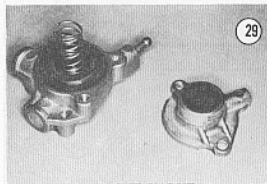
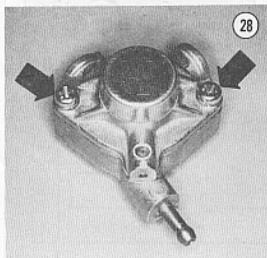
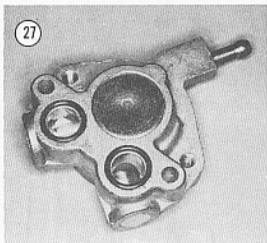

AIR CUT VALVE

Removal/Installation

To remove the air cut valve, remove the 2 screws shown in Figure 26, and lift the valve

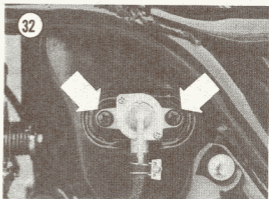
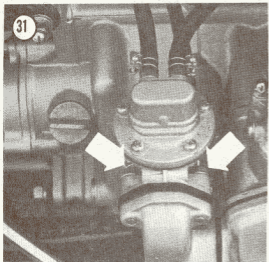
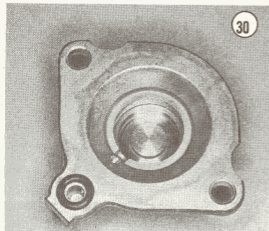

off. Disconnect the hose. Installation is the reverse of this procedure. Make sure that the O-rings on the bottom are in good condition; replace them if necessary.

NOTE: It is not necessary to remove the carburetor assembly to reach the valve. Simply remove the air cleaner assembly.

Disassembly/Assembly

1. Pry the 2 O-rings out of the bottom. See Figure 27.
2. Remove the 2 screws securing the top cover. See Figure 28.
3. Lift off the cover and spring. See Figure 29.
4. Pull up carefully on the diaphragm and lift it out.

5. Pry O-ring out of the cover. See Figure 30.
6. Assembly is the reverse of these steps. Replace the O-rings and diaphragm if damaged or deteriorated.

FUEL PUMP

The fuel pump must be replaced as an assembly. Internal part replacements are not available.

Removal/Installation

1. Turn fuel petcock to OFF.
2. Disconnect 2 fuel lines at fuel pump.
3. Remove 2 bolts securing pump to mounting flange. See Figure 31.
4. Installation is the reverse of this procedure. Use new gaskets on each side of plastic spacer.

FUEL PETCOCK

Replacement

1. Drain fuel tank into safe container.
2. Disconnect fuel line at petcock.
3. Remove 2 screws securing petcock to tank. See Figure 32.
4. Installation is the reverse of these steps.

Repair

Every part of the petcock is available as a replacement part. To disassemble the petcock:

1. Remove 2 cover screws. See Figure 33.
2. Lift off cover, circular spring, and lever.
3. Lift out gasket.
4. Installation is the reverse of these steps.

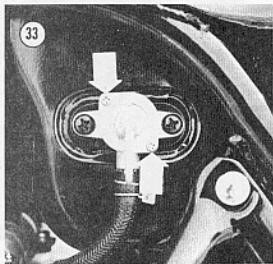

Fuel Sender Replacement

1. Remove seat. See Chapter Twelve.
2. Disconnect battery ground cable.
3. Disconnect electrical wire from sender. See Figure 34.
4. Unscrew sender retainer from tank. Lift sender out.

WARNING

Exposed fuel in tank is very dangerous. Do not permit smoking or any open flames in the area as long as the sender is off.

5. Installation is the reverse of these steps. Use a new gasket.

FUEL TANK

Removal/Installation

1. Remove the right side cover.
2. Remove the seat.
3. Disconnect the tail and turn signal light wires.
4. Remove the grab rail with the turn signals still mounted.
5. Remove the rear fender sections.
6. Remove the cotter pin and clevis securing the brake pedal to the master cylinder. Remove the 2 bolts mounting the master cylinder to the frame. See Figure 35.
7. Hang the rear master cylinder out of the way, but leave the hydraulic line connected.

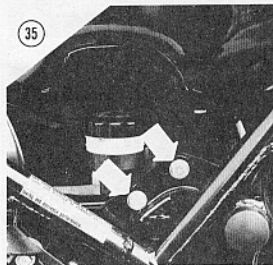

8. Remove the battery and the battery box.
9. Remove the fuel tank drain plug, and drain the fuel into a sealable container made for fuel storage.

WARNING

Do not use glass or plastic bottles. Glass is easily broken, and gasoline dissolves some plastics.

10. Remove the fuel petcock. See Figure 32.
11. Disconnect the fuel sender wires.
12. Remove the tank mounting bolt at the rear of the tank, and the cross plate near the front of the tank. See Figure 34.
13. Remove 4 bolts securing the service compartment.
14. Lift the service compartment enough to clear the fuel filler neck.
15. Slide the fuel tank toward the rear of the frame, and lift it out when clear.

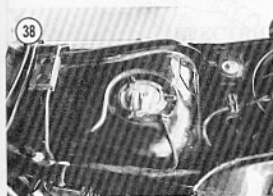

EXHAUST SYSTEM

The exhaust system consists of the exhaust headers and a muffler(s). See Figure 36.

Header Removal/Installation

1. Loosen clamp securing header to muffler. See Figure 37.
2. Remove 4 nuts holding each header to the cylinder heads. See Figure 38.
3. Disconnect header from cylinder head studs and slide the header out of the muffler.
4. Installation is the reverse of these steps. Use new copper packings in the cylinder heads.

Muffler Replacement

1. Raise bike on centerstand.
2. Remove rear wheel.
3. Remove clamps securing muffler to header pipes. See Figure 37.
4. Remove bolts securing rear footpegs and muffler to frame.
5. Remove muffler(s).
6. Installation is the reverse of these steps.

Table 1 FUEL SYSTEM SPECIFICATIONS

Carburetor	1975	1976	1977	1978	1979
Venturi size (mm)	32	32	32	31	31
Float level	0.83 in. (21mm)	0.83 in. (21mm)	0.83 in. (21mm)	0.83 in. (21mm)	0.83 in. (21mm)
Primary main jet	65	62	62	60	60
Secondary main jet	125	120	120	120	120
Primary air jet	60	60	60	60	60
Secondary air jet	120	120	120	120	140
Slow air	125	115	110	120	130
Slow fuel jet	35	35	35	35	35
Pilot screw setting (turns out)	1½	2	2½	1½	2
Fuel Pump					
Pressure	2.0 psi (0.14 kg/cm ²) @ 5,000 rpm; 2.3 psi (0.16 kg/cm ²) @ idle				
Capacity	1.5oz (450cc) per minute @ 3,000 rpm				
Fuel Tank Capacity					
Total	5 U.S. gallons (19 liters)				
Reserve	0.8 U.S. gallons (3 liters)				
Fuel Octane	86 (pump), 91 (research)				

36

EXHAUST SYSTEM

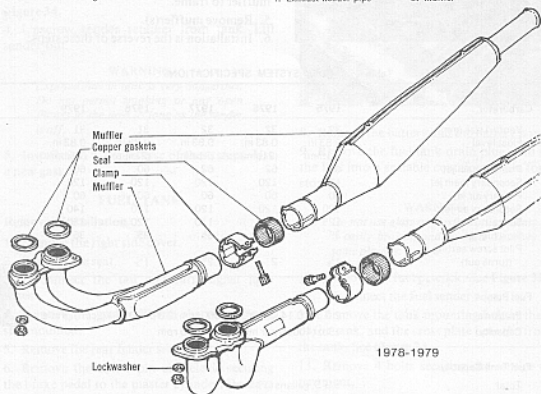
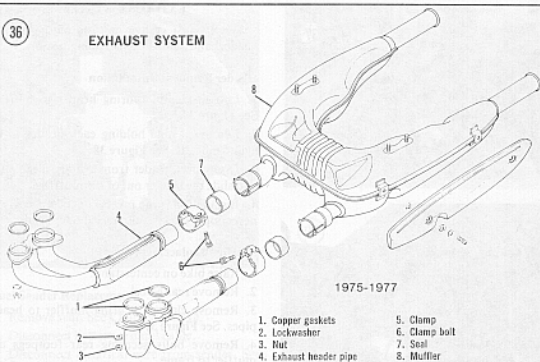

NOTE: If you own a 1980 or later model, first check the Supplement at the back of the book for any new service information.

CHAPTER SEVEN

ELECTRICAL SYSTEM

The electrical system includes the following systems (each is described in detail in this chapter):

- Charging system
- Ignition system
- Lighting system
- Directional signals
- Horn

CHARGING SYSTEM

The charging system consists of the battery, alternator, rectifier and regulator (Figure 1).

The alternator generates an alternating current (AC) which the rectifier converts to direct current (DC). The regulator maintains the voltage to the battery and load (lights, ignition, etc.) at a constant voltage regardless of variations in engine speed and load.

Testing Charging System

Whenever a charging system trouble is suspected, make sure the battery is fully charged and in good condition before going any further. Clean and test the battery as described in the following section.

Prior to starting the test, start the bike and let it run for 5 minutes. Do not let the engine run longer as the cooling fan must not be in operation during this test.

To test the charging system, connect a 0-15 volt DC voltmeter to the battery as shown in Figure 2A. Connect the voltmeter positive lead to the battery positive terminal and voltmeter negative lead to ground.

NOTE

Do not disconnect either the positive or negative battery cables; they are to remain in the circuit as is.

Connect a 0-10 volt DC ammeter in line with the main fuse connectors (fusible link). Loosen the screws securing the fusible link and remove the fusible link. Install an inline fuse/fuse holder (available at most auto supply or electronic supply stores) along with the ammeter as shown in Figure 2B. Use alligator clips on the test leads for a good electrical connection.

NOTE

During the test if the needle of the ammeter reads in the opposite direction on the scale, reverse the polarity of the test leads.

CAUTION

In order to protect the ammeter, always run the test with the inline fuse in the circuit.

1

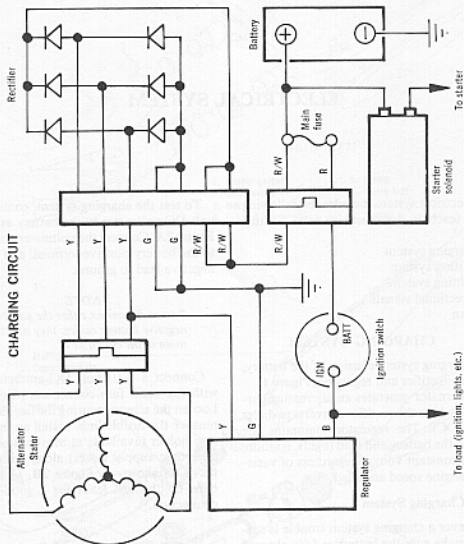

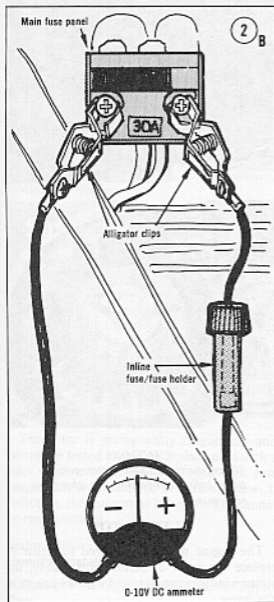
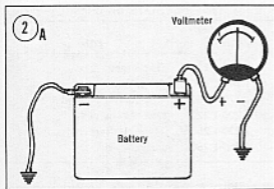
**CAUTION**

Do not try to test the charge system by connecting an ammeter between the positive battery terminal and the starter cable. The ammeter will burn out when the electric starter is operated.

Turn the headlight dimmer switch to the HIGH position (make sure the cooling fan is not running—the engine must be warm but not hot). Start the engine and run it at 5,000 rpm. Minimum charging current should be 3 amperes. Voltage should read 14.5 volts.

If the voltage is considerably lower than specified, check the alternator and voltage regulator/rectifier. Less likely is the possibility that the voltage is too high; in that case the voltage regulator is probably at fault. If amperage is too low, check the alternator.

Test the separate charging systems components as described under appropriate headings in the following section.

Disconnect the voltmeter and ammeter and reinstall the fusible link.

BATTERY**Care and Inspection**

1. Remove left side cover.
2. Remove the battery hold-down strap. See Figure 3.
3. Disconnect battery cables and vent lines.
4. Remove battery.

CAUTION

Do not start engine with battery removed or the rectifier will be damaged.

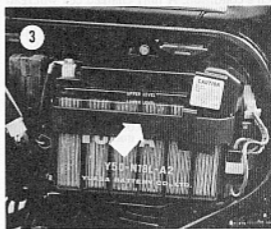

5. Clean top of battery with baking soda solution. Scrub with a stiff bristle brush. Wipe battery clean with a cloth moistened in ammonia solution, then flush with clean water.

CAUTION

Keep cleaning solution out of battery cells or the electrolyte will be seriously weakened.

6. Clean the battery terminals with a stiff wire brush.
7. Examine entire battery case for cracks.
8. Install the battery and reconnect the battery cables. Observe battery polarity.
9. Coat the battery connections with light mineral grease or Vaseline after tightening.
10. Check the electrolyte level and top up if it is necessary.
11. Install side cover.

Testing

Hydrometer testing is the best way to check battery condition. Use a hydrometer with numbered graduations from 1.100 to 1.300 rather than one with color-coded bands. To use the hydrometer, squeeze the rubber ball, insert the tip in the cell, and release the ball. Draw enough electrolyte to float the weighted float inside the hydrometer. Note the number in line with surface of the electrolyte; this is the specific gravity for this cell. Return the electrolyte to the cell from which it came.

The specific gravity of the electrolyte in each battery cell is an excellent indication of that cell's condition. A fully charged cell will read 1.275-1.380, while a cell in good condition may read from 1.250-1.280. A cell in fair condition reads from 1.225-1.250 and anything below 1.225 is practically dead.

Specific gravity varies with temperature. For each 10° that electrolyte temperature exceeds 80° F, add 0.004 to the reading indicated on the hydrometer. Subtract 0.004 for each 10° below 80° F.

If the cells test in the poor range, the battery requires recharging. The hydrometer is useful for checking the progress of the charging operation. Table 1 shows approximate state of charge.

Table 1 STATE OF CHARGE

Specific Gravity	State of Charge
1.110-1.130	Discharged
1.140-1.160	Almost discharged
1.170-1.190	One-quarter charged
1.200-1.220	One-half charged
1.230-1.250	Three-quarters charged
1.260-1.280	Fully charged

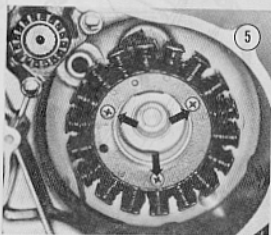
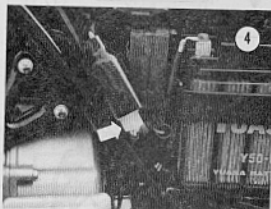

CAUTION

Always disconnect both battery connections before connecting the charging equipment.

ALTERNATOR

The engine must be removed to repair or replace the rotor or stator. Fortunately, the stator windings can be tested with the engine in the frame.

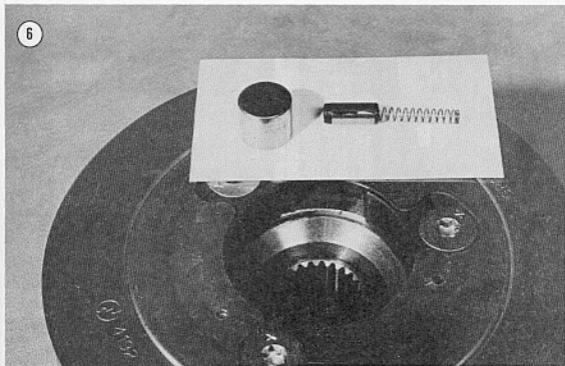

Testing the Stator

Check the stator for shorts and open circuits with an ohmmeter. Disconnect the stator plug at the point shown in Figure 4. Measure between any yellow and each of the other 2 leads; resistance should be about 1.1 ohms for both readings. Significantly lower readings indicate a short. Significantly higher or an "infinity" reading indicates an open circuit. In either case, replace the stator. Also measure from any lead to ground (engine case). The ohmmeter should read "infinity." If there is any other reading, the stator is shorted to the rear cover.

Testing the Rotor

The rotor is permanently magnetized and cannot be tested except by replacement with a rotor known to be good. A rotor can lose magnetism from old age or a sharp blow. If defective, the rotor must be replaced; it cannot be remagnetized.

Stator/Rotor Removal/Installation

1. Remove the engine as described in Chapter Four.

2. Remove the rear cover as described under *Rear Cover Removal* in Chapter Four.

3. Remove 3 screws securing the stator to the rear engine cover. See Figure 5.

4. Insert large drift into one of the holes around the stator. Remove center bolt with breaker bar, using the drift to keep the rotor from turning.

5. Slide the rotor off. If replacing the rotor, remove the 3 rollers, seats and springs from the old rotor and install them in the new rotor. See Figure 6.

6. Slide new rotor on and secure with bolt. Tighten bolt to 58-69 ft.-lb. (8.0-9.0 mkg).

7. Install stator with 3 screws.

8. Install rear cover as described in Chapter Four.

9. Install engine as described in Chapter Four.

RECTIFIER

Removal/Installation

1. Remove left side cover.

2. Remove 2 bolts securing rectifier to battery box. See Figure 7.

3. Disconnect wires from rectifier.

4. Installation is the reverse of these steps.

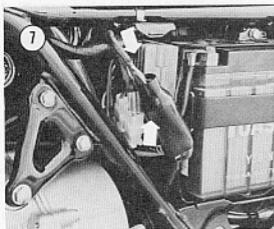

Testing

To test rectifier, disconnect the plug from the harness. See Figure 8. Make the following measurements, using an ohmmeter set at RX10.

1. Connect either ohmmeter lead to one of the green rectifier leads. Connect the other ohmmeter lead to each of the yellow leads. These 3 measurements must be the same, either all very high resistance or very low resistance. If one or more differ, the rectifier is bad and the entire rectifier must be replaced.
2. Reverse ohmmeter leads and repeat Step 1. This time, the readings must also be the same, but just the opposite from the measurements in Step 1. For example, if all readings in Step 1 were low, all readings in this step must be high and vice versa. Replace the rectifier if these measurements are not correct.
3. Connect either ohmmeter to one of the red/white rectifier leads. Connect the other ohmmeter lead to each of the yellow leads. These 3 measurements must be the same, either all very high or all very low. Replace the rectifier if these measurements are not correct.
4. Reverse ohmmeter leads and repeat Step 3. This time, the readings must also be the same, but just the opposite from the measurements in Step 3.

REGULATOR

The regulator is located inside the left pod cover. See Figure 9.

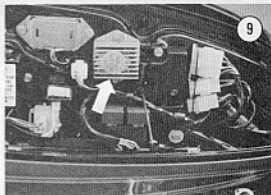

Testing

Test the charging system as described earlier. If the charging current is too high, replace the regulator.

Removal/Installation

1. Remove 2 bolts securing regulator to pod.
2. Disconnect plug connecting regulator to the harness.
3. Installation is the reverse of these steps.

IGNITION SYSTEM

The ignition system consists of a coil, spark plugs, and point set for each pair of cylinders. See Figure 10.

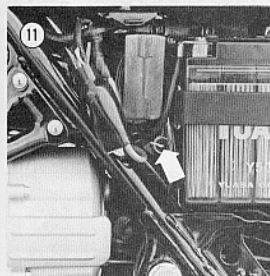
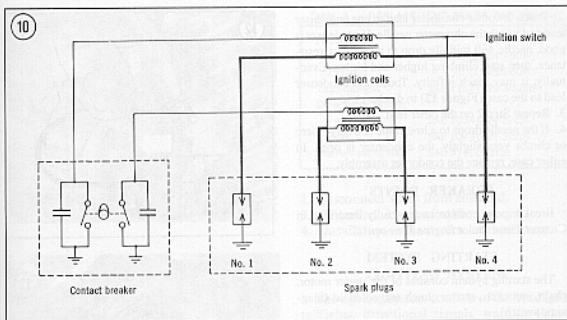

IGNITION COILS

Removal/Installation

- The coils are located under the center pod.
- Lower the left and right center pod covers.
- Remove upper coil mounting bolt from right side, and lower coil mounting bolt from the left side.
- Disconnect spark plug wires from plugs and pull wires out of retaining clips.
- Disconnect wires from harness.

- Pull ignition coils out either side.
- Installation is the reverse of these steps. Make sure that you route the spark plug wires to the proper cylinders. The wires are marked with the cylinder number.

Testing

The only certain test for a suspected coil is to replace it with a known good coil. Interchange the 2 coils and see if the symptoms change to the other cylinder bank.

CONDENSERS

Removal/Installation

Both of the condensers are in the same case, mounted near the rectifier. See Figure 11.

- Remove screws securing condensers to the battery box.
- Unplug leads.
- Installation is the reverse of these steps.

Testing

The condenser can be tested with ohmmeters which have an internal battery of 12 volts or less. Ohmmeters with larger batteries can destroy a good condenser as soon as connected.

- Connect one lead of ohmmeter to metal case of condenser.

2. Touch the other ohmmeter lead to one condenser lead and watch the ohmmeter needle. If condenser is good, needle will initially drop to a very low resistance, then start climbing higher and higher. Eventually, it may reach infinity. Touch the condenser lead to the case (**Figure 12**) to discharge it.
3. Repeat Step 2 on the other lead.
4. If the needle drops to a low value and stays there or climbs very slightly, the condenser is open. In either case, replace the condenser assembly.

BREAKER POINTS

Breaker point maintenance is fully described in Chapter Three under *Engine Tune-up*.

STARTING SYSTEM

The starting system consists of the starter motor, chain, sprockets, starter clutch and solenoid (magnetic switch).

Starter Motor Removal/Installation

The starter motor is mounted on the left side of the engine. See **Figure 13**.

1. Disconnect the left exhaust pipe from the engine (Chapter Six). Remove the rear exhaust pipe mounting stud.
2. Remove the shift lever.
3. Disconnect battery ground cable.
4. Disconnect starter wire from starter.
5. Remove 2 bolts securing motor. See **Figure 13**. Slide motor back carefully.
6. Installation is the reverse of these steps.

Starter Motor Brush Inspection/Replacement

1. Remove the starter as described above.
2. Remove the 2 long through-bolts, and pull off the brush cover.
3. Measure the brush length. See **Figure 14**. New brushes are 12-13 mm long. Replace the brushes if either one is 5.5 mm or less.
4. Install the brush cover, and secure it with the through-bolts.
5. Install the starter motor.

Starter Clutch

The starter clutch is part of the alternator rotor. See procedures in Chapter Four under

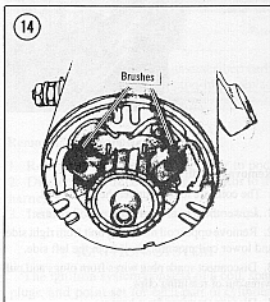
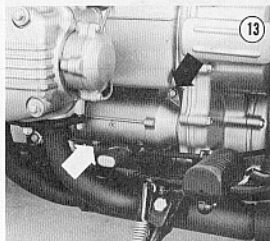
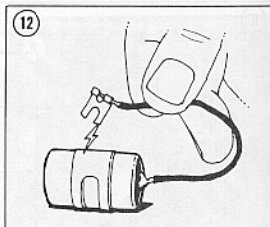

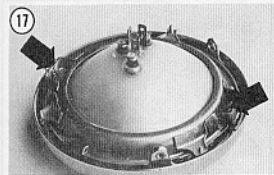
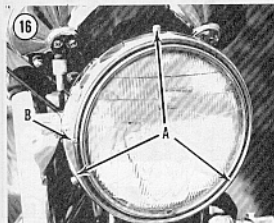
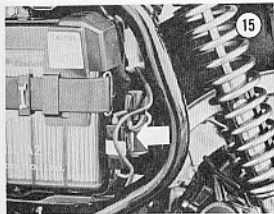

Alternator Rotor, Starter Clutch Disassembly/Assembly.

Starter Solenoid Removal/Installation

The starter solenoid is mounted near the battery. See Figure 15.

1. Remove battery.

Table 2 REPLACEMENT BULBS (U.S. Models)

Headlight	
1975-1977	GE4040 (12v/40-50W)
1978-on	(12v/55-60W)
Tail/stoplight	SAE 1157 (12v-3/32cp)
Directional signals	
Front	SAE 1034 (12v-32cp)
Rear	SAE 1073 (12v-32cp)
Instrument lights	SAE 57 (12v-2cp)

2. Disconnect wires from solenoid.
3. Pull solenoid out of rubber mount.
4. Installation is the reverse of these steps.

LIGHTING SYSTEM

The lighting system consists of the headlight, taillights, directional signals, warning lights, and stoplight. Table 2 lists replacement bulbs for these components.

Headlight Replacement (U.S. Models)

1. Remove the 3 mounting screws (A, Figure 16) and the adjusting screw (B, Figure 16). Remove the headlight from the case.
2. Disconnect the socket from light.
3. On sealed beam headlights, remove 2 retaining lock pins and screws from outer rim. See Figure 17. Remove 2 screws from inner rim and remove sealed beam.
4. On quartz bulb models, unclip the bulb retainer and remove the bulb.
5. Installation is the reverse of these steps. Adjust headlight as described in the following procedure.

CAUTION

When handling a quartz bulb, carefully read all instructions shipped with the replacement bulb. Do not touch the bulb glass with your fingers because of oil on your skin. Any traces of oil on the quartz bulb will drastically reduce the life of the bulb. Clean any traces of oil from the bulb with a cloth moistened in alcohol or lacquer thinner.

Headlight Replacement (European Models)

European models use a prefocused headlamp bulb and a city (pilot) lamp. To replace either bulb, see Table 3 and proceed as follows:

1. Remove retaining screws (Figure 18).
2. Pull headlight unit out.
3. Pull city lamp out of housing (Figure 19). Insert new bulb and push back into housing.
4. Disconnect plug to headlamp. Pry off retaining spring and lift out the bulb. See Figure 20.
5. Install new bulb. Do not handle glass envelope with your fingers. If you do, wipe it clean. The oil from your fingers can shorten bulb life.
6. Push headlight bulb down, and secure it with spring. Connect plug.
7. Install unit in housing with retaining screws.

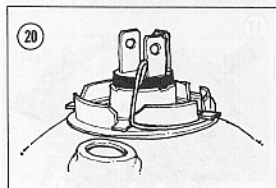
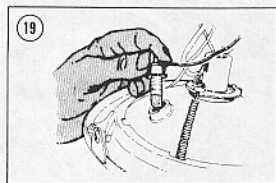
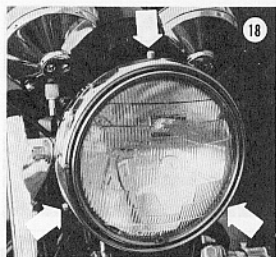

Headlight Adjustment

Adjust headlight horizontally and vertically according to Department of Motor Vehicle regulations in your area.

To adjust headlight horizontally, turn the screw (Figure 21). To adjust vertically, unscrew side reflectors and loosen bolts on either side of case. See Figure 22. Move headlight to desired position, then tighten bolts.

Taillight Replacement

A single bulb performs as a taillight, license plate light and stoplight. To replace the bulb, remove the lens and turn bulb counterclockwise. See Table 2 for replacement type.

Handlebar Switches

The handlebar switches which control the starter, lighting, etc. on U.S. and European models cannot be repaired. If defective, the whole switch housing must be replaced.

Front Stoplight

Switch Replacement (1975-1977)

The front stoplight switch operates from hydraulic brake pressure. It is mounted on the front brake fluid manifold. See Figure 23.

1. Disconnect electrical wires.

Table 3 REPLACEMENT BULBS
(European Models)

Headlight	12v45/40W
Turn signal	12v21W
City light	12v4W
Instruments	12v3.4W
Tail/brake	12v5/21W

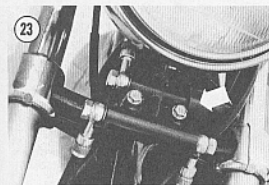
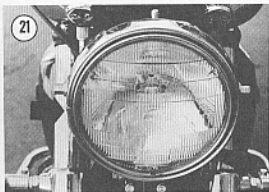

2. Siphon brake fluid from reservoir with a siphon used only for brake fluid.

WARNING

Do not suck brake fluid out with your mouth. Brake fluid is poisonous.

3. Unscrew the stoplight switch.

CAUTION

Catch dripping brake fluid before it can spill on painted surfaces. Brake fluid can

damage paint. If brake fluid does spill, flush it off with mild detergent and water immediately.

4. Installation is the reverse of these steps.
5. Fill brake reservoir and bleed brakes as described in Chapter Three.

Front Stoplight Switch Replacement (1978-on)

The front stoplight switch is operated from hydraulic brake pressure. It is mounted on the front master cylinder assembly.

1. Disconnect the electrical wires from the stoplight switch.
2. Remove the screw securing the switch to the master cylinder assembly and carefully pull the switch assembly out.
3. Install a new switch and the screw.
4. Reconnect the electrical wires.

Rear Stoplight Switch Adjustment

The rear stoplight switch is located on the right side, in front of the side cover. See Figure 24. To adjust the switch:

1. Turn the ignition switch on.
2. Depress brake pedal. Light should come on just as the brake begins to work.
3. To make light come on sooner, hold switch body and turn adjusting nut clockwise as viewed from top. Turn the nut counterclockwise to delay the light.

NOTE

Some riders prefer the light to come on a little early. This way, they can tap the pedal without braking to warn drivers who follow too closely.

Rear Stoplight Switch Replacement

To replace the switch, disconnect spring and wires and pull switch with locknut out of bracket. Installation is the reverse. Adjust as described above.

Directional Signal Switch Removal

1. Remove the 3 mounting screws (A, Figure 25) and the adjusting screw (B, Figure 25). Remove the headlight from the case.

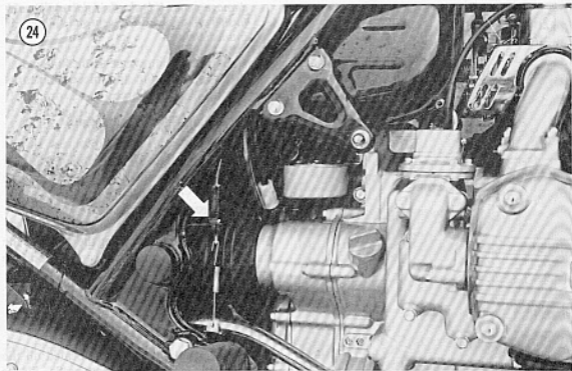

2. Disconnect 4 wires from harness.
3. Disconnect clutch cable as described in Chapter Five.
4. Remove mirror and clutch lever.
5. Remove screws securing switch assembly (Figure 26) and separate 2 halves.
6. Tie ends of switch wires to a piece of small rope (1/8-1/4 inch diameter) about 2-3 feet long.
7. Pull switch wires out of handlebars. Leave the rope in place in the handlebars with one end sticking out of the center hole and the other end sticking out of the end hole.

Directional Signal Switch Installation

1. Tape end of switch wires to rope sticking out of end hole.
2. Pull on rope at center hole and pull wires through handlebars. Untape rope.
3. Secure switch to handlebars.
4. Mount mirror and clutch lever.
5. Connect the clutch cable and adjust the lever free play.
6. Insert switch wires into headlight housing and reconnect to harness.

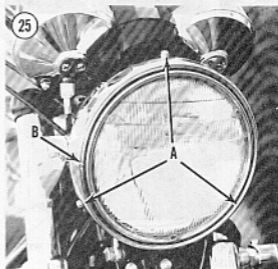

7. Install headlight.

Indicator Light Replacement

Remove 2 screws securing indicator panel. Lift off the panel and replace the defective bulb. See Table 2 for bulb type. Install panel; do not overtighten screws or the panel may crack.

Signal Light Replacement

To replace any of the 4 directional signal lamps, remove lens and replace bulb. Install lens, but do not overtighten screws.

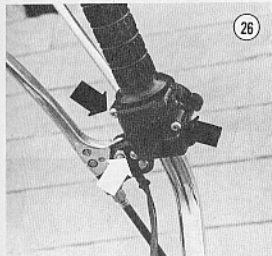

Flasher Relay Replacement

The flasher relay is located inside the left pod cover. See Figure 27 (1975-1977) or Figure 28 (1978-on). Pull old flasher relay out of the rubber mount. Transfer wires to new relay and install the relay in rubber mount.

HORN

Removal/Installation

1. Disconnect horn connector from harness.
2. Remove 2 bolts securing horn to bracket.
3. Installation is the reverse of these steps.

Testing

1. Disconnect horn wires from harness.
2. Connect horn wires to 12-volt battery. If it is good, it will sound.

Switch Removal/Installation

The horn switch is part of the directional signal assembly.

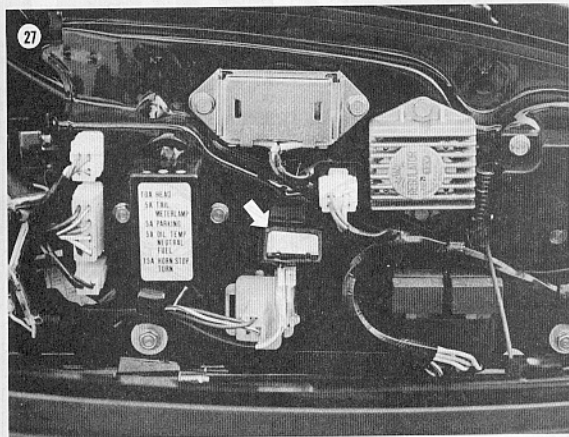

FUSES

There are several fuses on the GL-1000. The main fuse on all models is located near the rear edge of the battery. See **Figure 29**. On 1975-1977 models additional fuses are located in a fuse box mounted inside the left pod cover. See **Figure 30**. On 1978 and later models additional fuses are located in a fuse box mounted below the tool tray. See **Figure 31**. The function of each fuse is marked on the outside of the fuse box cover.

Whenever a fuse blows, find out the reason for the failure before replacing the fuse. Usually, the trouble is a short circuit in the wiring. This may be caused by worn-through insulation or a disconnected wire shorting to ground.

CAUTION

Never substitute tinfoil or wire for a fuse. Never use a higher amperage fuse than specified. An overload could result in fire and complete loss of the bike.

WIRING DIAGRAMS

Wiring diagrams are included at the end of the book.

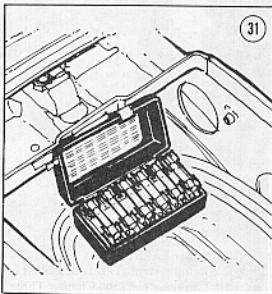
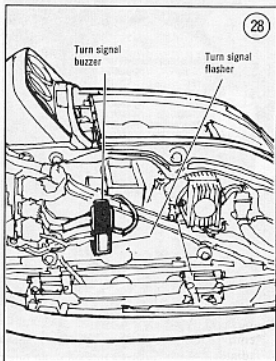
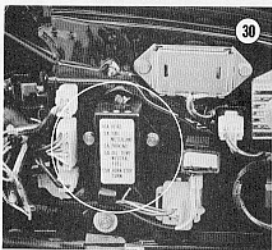
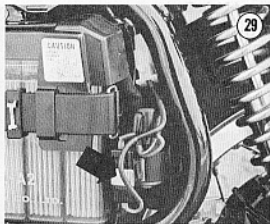

CHAPTER EIGHT

COOLING SYSTEM

The cooling system consists of the radiator, water pump, thermostat, thermostatically controlled fan, and coolant recovery tank.

This chapter describes repair and replacement of cooling system components. Table 1 summarizes cooling system specifications. Refer to Chapter Three for routine maintenance.

RADIATOR

Removal/Installation

1. Drain cooling system as described under *Changing Coolant* in Chapter Three.
2. Remove 2 acorn nuts at top of radiator. See Figure 1.
3. Remove 2 black bolts at bottom of radiator. See Figure 2.
4. Pull radiator forward slightly.
5. Disconnect electrical plug for fan.
6. Loosen clamps on upper and lower hoses. See Figure 3.
7. Pull hoses free and remove radiator.
8. Installation is the reverse of these steps. Refill the cooling system. This is described in Steps 6-10, *Changing Coolant*, Chapter Three.

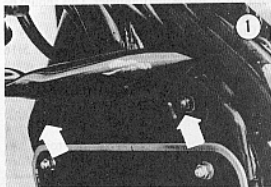

Table 1 COOLING SYSTEM SPECIFICATIONS

Coolant type	50/50 mixture ethylene glycol and water
Capacity	3.4 U.S. quarts; 2.8 Imp. qt. (3.2 liters)
Thermostat opens	176-183°F (80-84°C)

FAN

Removal/Installation

1. Remove the radiator as described in the previous procedure.
2. Remove 2 bolts securing the fan bracket to the radiator.

- Remove 3 screws holding the fan motor to the bracket and remove the motor.
- Installation is the reverse of these steps.

THERMOSTAT

Replacement

- Remove radiator as described earlier.
- Remove 2 bolts securing the water outlet to the thermostat housing.
- Lift out the thermostat.
- Installation is the reverse of these steps. Use a new O-ring in the water outlet.

Testing

- Slip a 0.002 in. (0.05 mm) feeler gauge between the valve and its seat.
- Submerge the thermostat in water with a thermometer as shown in **Figure 4**.
- Heat the water and hold a slight tension on the feeler gauge.
- When the valve opens and the feeler gauge slips out, read the thermometer. This should be about 176-183° F (80-84° C).
- Continue to heat the water to about 203° F (95° C). The valve should be open about 5/16 in. (8 mm). To measure this underwater, mark a tapered screwdriver blade at a point 5/16 in. wide (**Figure 5**). Insert the screwdriver blade between valve and its seat; you should be able to insert it up to the mark.
- If the thermostat opens at the wrong temperature, does not open fully, or does not open at all, replace it.

COOLANT CHANGE

The engine coolant must be changed every 24,000 miles or every 2 years, whichever comes first, to ensure adequate corrosion protection and freezing protection. See *Changing Coolant* in Chapter Three.

NOTE

If coolant is leaking from the weep hole in the water pump housing, the impeller O-ring seal should be replaced.

HOSE REPLACEMENT

Hoses deteriorate with age and should be replaced periodically or whenever they show

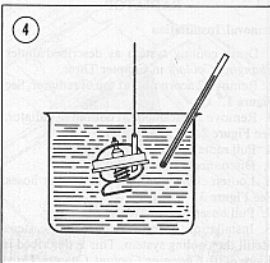
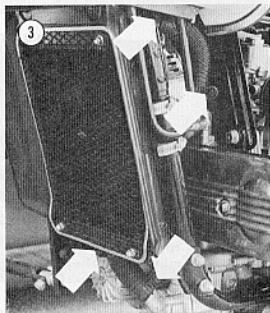
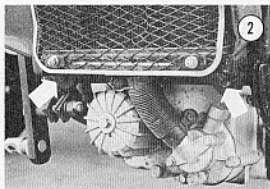

signs of cracking or leaking. To be safe, replace the hoses every 2 years. The spray from a cracked hose can injure the rider. Loss of coolant can cause the engine to overheat and be damaged.

To replace a hose:

1. Drain the coolant as described under *Changing Coolant* in Chapter Three.
2. Remove 2 acorn nuts at top of radiator. See **Figure 1**.
3. Remove 2 bolts at bottom of radiator. See **Figure 2**.
4. Pull radiator forward slightly.

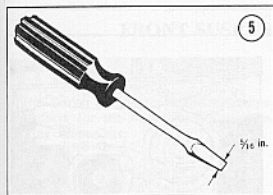

5. Loosen hose clamps at both ends of hose.
6. Pull hose off both ends.
7. Install new hose by reversing these steps. Make sure that you install the coiled metal hose protector over the hose. See **Figure 6**. Refill the system with coolant. Run the engine and check for leaks.

WATER PUMP

The water pump can be removed with the engine in the frame. **Figure 7** is an exploded view of the water pump.

Removal/Installation

1. If engine is in the frame, drain the engine oil and coolant. See Chapter Three. Also remove the radiator as described in this chapter.
2. Remove 4 bolts (4, **Figure 7**) securing the water pump housing to the engine front cover.

CAUTION

Do not drop or hit the impeller as it is made of plastic and will easily fracture or break. This is especially true on a well run-in machine as the plastic becomes brittle with age.

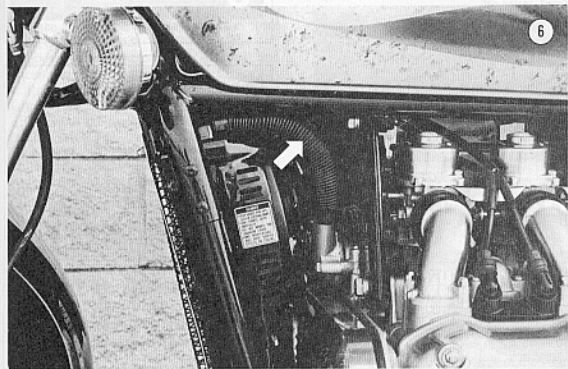

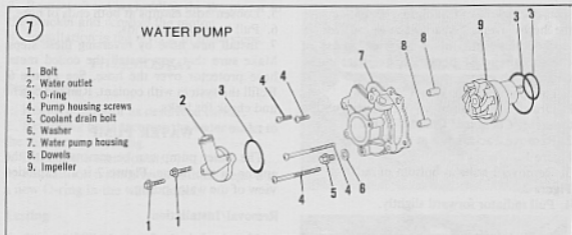

3. Pull the water pump off. If necessary, tap it off with a soft mallet.

NOTE

Steps 4-6 are not necessary unless the impeller or impeller seals must be replaced.

4. Remove 2 bolts (1, Figure 7) securing water hose outlet. Pull off cover.

5. Remove screws securing the engine front cover to the crankcase. See Figure 8. Pull the front cover off.

CAUTION

Usually the 2 dowel collars for the oil passages will fall out. Don't lose them.

6. Remove snap ring securing impeller in front engine case and pull the impeller out.

7. Assembly is the reverse of these steps. Use new gaskets and O-rings. Refill the engine with oil and coolant.

NOTE

If there is water in the engine oil, the O-rings around the impeller shaft or engine front cover are probably leaking.

TEMPERATURE SENDER AND FAN CONTROL SWITCH

The coolant temperature sender and the fan control switch are accessible from the right side of the engine. See Figure 9. To replace either component, disconnect the wire and unscrew the component with a deep socket wrench.

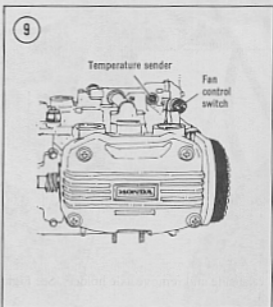
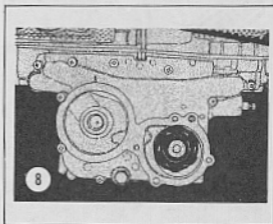

NOTE: If you own a 1980 or later model, first check the Supplement at the back of the book for any new service information.

CHAPTER NINE

FRONT SUSPENSION AND STEERING

This chapter includes repair and replacement procedures for the front wheel, forks, and steering components.

FRONT WHEEL

Removal

1. Rest the bike on the centerstand.
2. Place jack under engine and raise front wheel clear of ground.
3. Loosen speedometer cable setscrew and disconnect speedometer cable. See Figure 1.
4. Remove 2 bolts securing left caliper to front fork (Figure 2) and lift caliper off. Hang it up with wire to keep tension off of brake line.

NOTE

Insert a piece of wood in the caliper in place of the brake disc. That way if the brake lever is inadvertently squeezed, the piston will not be forced out of the cylinder. If this does happen, the caliper may have to be disassembled to reseat the piston and the system bled. By using the piece of wood, bleeding the brake is not necessary when installing the wheel.

5. Remove 4 axle holder nuts and washers on each side and remove axle holders. See Figure 3.
6. Lift front wheel free.

Installation

1. Insert the wheel between the front forks.
2. Fit the right brake disc carefully between the right caliper halves.
3. With the front fork cut-outs resting on the axle, install the 2 axle holders with the "F" for-

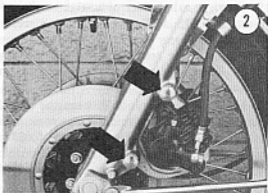
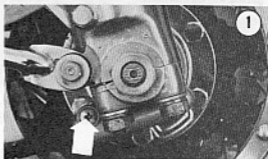

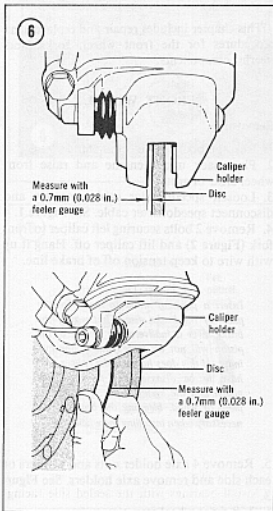
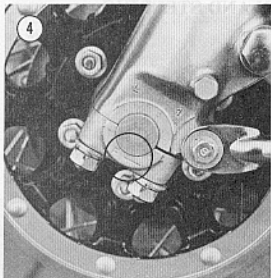
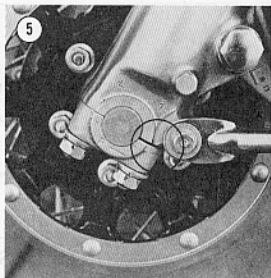
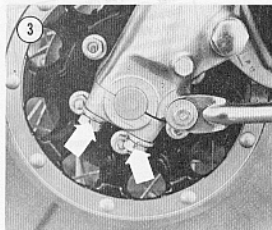

ward. See **Figure 4**. Tighten forward axle holder nuts lightly.

4. Install left caliper and tighten bolts to 22-29 ft.-lb. (3.0-4.0 mkg).

5. On *right* axle holder only, tighten *forward* nuts to 13-18 ft.-lb. (1.8-2.5 mkg) before tightening the rear nuts at all. This will leave a small gap at the rear of the holders. See **Figure 5**. Then torque the rear nuts to the same torque.

6. Measure the clearance between the outside surface of the left disc and the rear edge of the left caliper as shown in **Figure 6**. Use a 0.028 in. (0.7mm) feeler gauge.

7. If clearance measured above is 0.028 in. (0.7mm) or greater, tighten the forward nuts on

the left axle holder to 13-18 ft.-lb. (1.8-2.5 mkg), then tighten the rear nuts to the same torque.

8. If clearance is less than specified above, pull the left fork outward until clearance is correct, leave the feeler gauge in place and tighten the axle holder nuts— front nuts first, then rear nuts. Remove the feeler gauge.

9. Check clearance at other points between caliper and disc and make sure that it is at least as great as specified.

10. Turn wheel by hand and make sure that it turns smoothly. Apply brakes several times and check again for smooth rotation and adequate disc-caliper clearance.

Disassembly

Refer to **Figure 7** for this procedure.

1. Remove front axle nut (5) and pull axle out.
2. Remove 6 bolts securing brake discs to hub. Remove discs, speedometer gearbox (3), and seal (7).
3. Remove right bearing and spacer tube.
4. Remove seal and left bearing retainer. Lift left bearing out.

Inspection

1. Check brake components as described in Chapter Eleven.
2. Clean bearings thoroughly in solvent.
3. Clean hub inside and out with solvent.
4. Turn each bearing by hand. Make sure bearings turn smoothly. Check balls for evidence of wear, pitting, or excessive heat (bluish tint). Replace bearings if questionable.
5. Check axle for wear and straightness. **Figure 8** shows one method.

Assembly

1. Pack bearings thoroughly with multipurpose grease. Work grease in between balls thoroughly.
2. Pack wheel hub with grease.
3. Insert spacer.
4. Install bearings with the sealed side facing outward.

CAUTION

When tapping the bearings into place, tap on outer race only. Do not tap on inner race or the bearing might be damaged.

5. Install left bearing retainer and dust seal.
6. Install brake discs, speedometer gearbox, etc.

Wheel Balancing

An unbalanced wheel can be dangerous. Depending on the degree of unbalance and speed, the rider may experience anything from mild vibration to violent shimmy. In severe cases, the rider can lose control.

Wheels are relatively easy to balance without special equipment. Your dealer has an assortment of balance weights which attach to the spokes. They are crimped on to the light side of the wheel with ordinary gas pliers. Refer to **Figure 9**. Buy a couple of each weight available. If undamaged, you can return the unused weights.

ComStar wheels require stick-on weights with self-adhesive. Install weights on center rib of rim.

Before balancing a wheel, make sure bearings are in good condition and properly lubricated. Use the *Front Wheel, Disassembly/Inspection/Assembly* procedure in this chapter to be sure. In addition, make sure that the brakes do not drag. The wheel must rotate freely.

1. Rest bike on centerstand.
2. Place jack under engine and raise front wheel clear of ground.
3. Rotate rear wheel slowly and allow it to come to rest by itself. Note position of valve stem.
4. Repeat Step 3 several times. If the valve stem stops at a different position each time, the wheel is balanced. If the valve stem stops near the same position each time, attach weight at the 12 o'clock position (light side) until valve stem no longer favors one position when the wheel stops.
5. Road test bike on smooth, straight road.

7

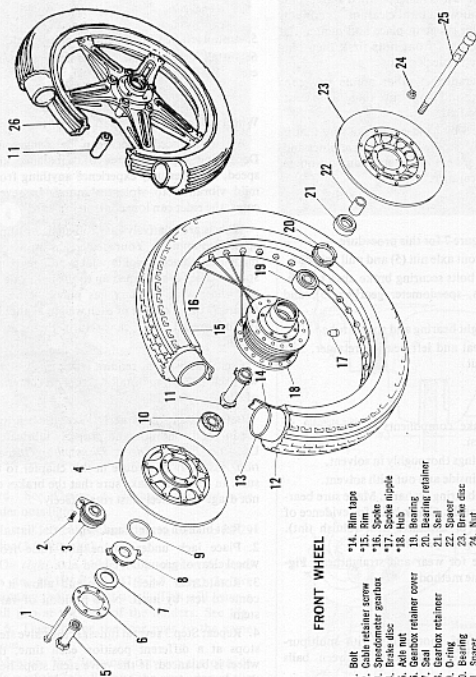

FRONT WHEEL

- 1. Bolt
- 2. Cable retainer screw
- 3. Speedometer gearbox
- 4. Brake disc
- 5. Axle nut
- 6. Gearbox retainer cover
- 7. Seal
- 8. Gearbox retainer
- 9. O-ring
- 10. Bearing
- 11. Spacer
- 12. Tire
- 13. Inner tube
- 14. Rim tape
- 15. Rim
- 16. Spoke
- 17. Socket nipple
- 18. Hub
- 19. Bearing
- 20. Bearing retainer
- 21. Seal
- 22. Spacer
- 23. Brake disc
- 24. Nut
- 25. Axle
- 26. ComStar wheel

*Wire wheel only.

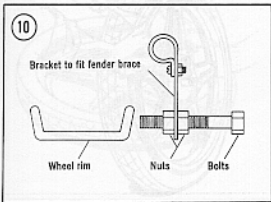
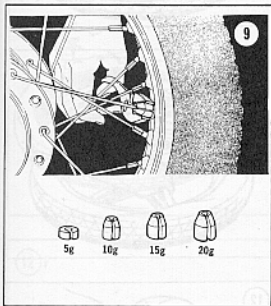
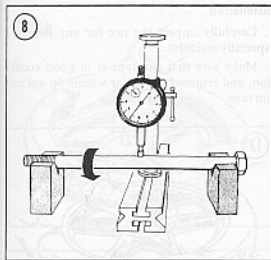

Spoke Adjustment (1975-1977 only)

Spokes loosen with use and should be checked periodically. If all appear loose, tighten all spokes on one side of the hub, then tighten all the spokes on the other side. One-half to one turn should be sufficient; don't overtighten. If you have a torque spoke wrench, tighten spokes to 17-38 in.-lb. (0.2-0.45 mkg).

After tightening spokes, check rim runout to be sure you haven't pulled the rim out of shape.

One way to check rim runout is to mount a dial indicator on the front fork so that it bears on the rim.

If you don't have a dial indicator, improvise as shown in Figure 10. Adjust position of bolt until it just clears rim. Rotate rim and note whether clearance increases or decreases. Mark the tire with chalk or crayon at areas that produce significantly large or small clearance. Clearance must not change by more than 0.08 in. (2mm).

To pull rim out, tighten spokes which terminate on the same side of hub and loosen spokes which terminate on opposite side of hub. See Figure 11. In most cases, only slight

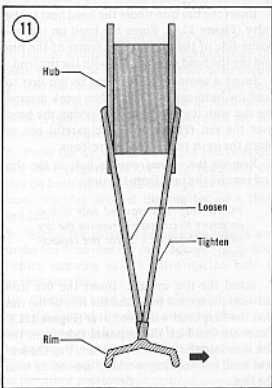

amount of adjustment is necessary to true rim. After adjustment, rotate rim and make sure another area has not been pulled out of true. Continue adjustment and checking until runout does not exceed 0.08 in. (2mm).

TIRE CHANGING

The stock ComStar wheels have aluminum rims and the exterior appearance can easily be damaged. Special care must be taken with tire irons when changing a tire to avoid scratches and gouges to the outer rim surface.

You may want to make a simple wood support of 2 x 4's with an inside dimension of approximately 17 in. x 17 in. (large enough to accommodate the brake disc and small enough to support the rim). This will protect the brake disc and the wheel rim at the same time.

Removal

1. Remove the valve core to deflate the tire.
2. Press the entire bead on both sides of the tire into the center of the rim.
3. Lubricate the beads with soapy water.
4. Insert the tire iron under the bead next to the valve (**Figure 12A**). Force the bead on the opposite side of the tire into the center of the rim and pry the bead over the rim with the tire iron.
5. Insert a second tire iron next to the first to hold the bead over the rim. Then work around the tire with the first tire iron, prying the bead over the rim (**Figure 12B**). Be careful not to pinch the inner tube with the tire irons.
6. Remove the valve from the hole in the rim and remove the tube from the tire.

NOTE: Step 7 is required only if it is necessary to completely remove the tire from the rim, such as for tire replacement.

7. Stand the tire upright. Insert the tire iron between the second bead and the side of the rim that the first bead was pried over (**Figure 12C**). Force the bead on the opposite side from the tire iron into the center of the rim. Pry the second bead off the rim, working around as with the first.

Installation

1. Carefully inspect the tire for any damage, especially inside.
2. Make sure that rim tape is in good condition, and centered. ComStar wheels do not use rim tape.

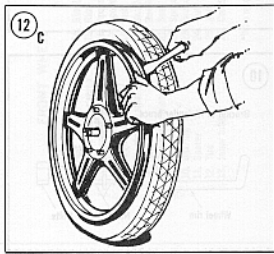
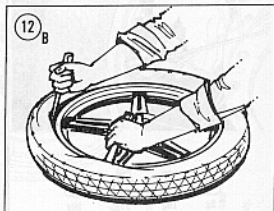
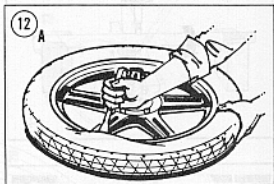

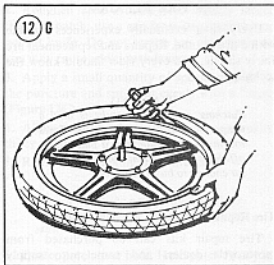
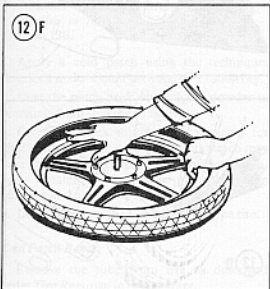
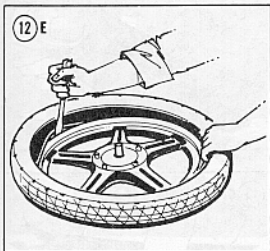
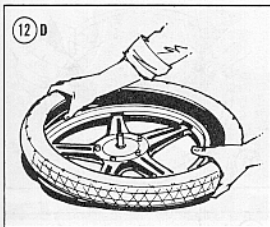

3. A new tire may have balancing rubbers inside. These are not patches and should not be disturbed. A colored spot near the bead indicates a lighter point on the tire. This spot should be placed next to the valve stem.

4. Inflate the tube just enough to round it out. Too much air will make installation difficult.

5. Place the tube inside the tire.

6. Lubricate both beads of the tire with soapy water.

7. Place the backside of the tire into the center of the rim and insert the valve stem through the stem hole in the wheel. The lower bead should go into the center of the rim and the upper bead outside. Work around the tire in both directions (Figure 12D). Use a tire iron for the last few inches of bead (Figure 12E).

8. Press the upper bead into the rim opposite the valve (Figure 12F). Pry the bead into the rim on both sides of the initial point with a tire iron, working around the rim to valve (Figure 12G).

9. Wiggle the valve to be sure the tube is not under the bead. Set the valve squarely in its hole before screwing in the valve nut to hold it against the rim.

10. Check the bead on both sides of the tire for even fit around the rim. Inflate the tire slowly to seat the beads in the rim. It may be necessary to bounce the tire to complete the seating. Inflate to the required pressure. Balance the wheel as described previously.

TIRE REPAIRS

Every rider eventually experiences trouble with a tire or tube. Repairs and replacement are fairly simple, and every rider should know the techniques.

WARNING

Patching a motorcycle tube is only a temporary fix. A motorcycle tire flexes too much and could rub a patch right off. However, a patched tire will get you far enough to buy a new tube.

Tire Repair Kits

Tire repair kits can be purchased from motorcycle dealers and some auto supply stores. When buying, specify that the kit you want is for motorcycles.

There are two types of tire repair kits:

- Hot patch
- Cold patch

Hot patches are stronger because they actually vulcanize to the tube, becoming part of it. However, they are far too bulky to carry for roadside repairs, and the strength is unnecessary for a temporary repair.

Cold patches are not vulcanized to the tube; they are simply glued to it. Though not as strong as hot patches, cold patches are still very durable. Cold patch kits are less bulky than hot and more easily applied under adverse conditions. A cold patch kit containing everything necessary tucks in easily with your emergency tool kit.

Tube Inspection

1. Install the valve core into the valve stem. Inflate the tube slightly. Do not overinflate.
2. Immerse the tube in water a section at a time. See Figure 13A. Look carefully for bubbles indicating a hole. Mark each hole and continue checking until you are certain that all holes are discovered and marked. Also make sure that the valve core is not leaking; tighten it if necessary.

NOTE: *If you do not have enough water to immerse sections of the tube, try running your hand over the tube slowly and very close to the surface. If your hand is*

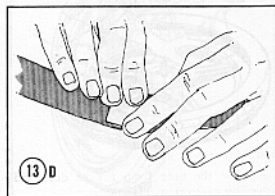
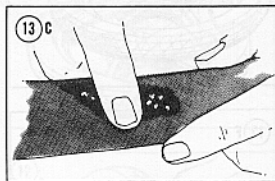
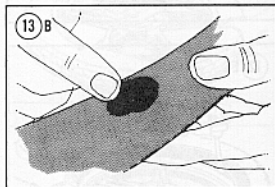
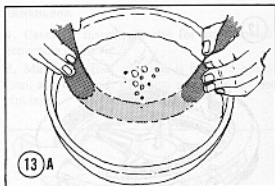

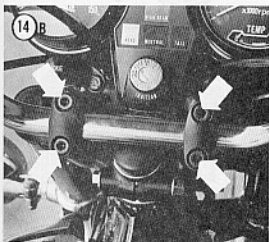
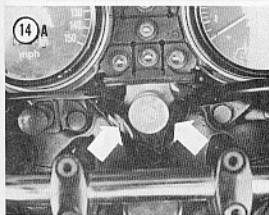

damp, it works even better. If you suspect a hole anywhere, apply some saliva to the area to verify it (Figure 13B).

3. Apply a cold patch using the techniques described under *Cold Patch Repair*, following.
4. Dust the patch area with talcum powder to prevent it from sticking to the tire.
5. Carefully check inside the tire casing for glass particles, nails or other objects which may have damaged the tube. If inside of tire is split, apply a patch to the area to prevent it from pinching and damaging the tube again.
6. Deflate tube prior to installation in the tire.

Cold Patch Repair

1. Remove the tube from tire as described under *Tire Removal* in this chapter.

2. Roughen area around hole slightly larger than the patch; use a cap from tire repair kit or pocket knife. Do not scrape too vigorously or you may cause additional damage.
3. Apply a small quantity of special cement to the puncture and spread it evenly with a finger (Figure 13C).
4. Allow cement to dry until tacky — usually thirty seconds or so is sufficient.
5. Remove the backing from the patch.

CAUTION

Do not touch the newly exposed rubber with your fingers or the patch will not stick firmly.

6. Center patch over hole. Hold patch firmly in place for about 30 seconds to allow the cement to set (Figure 13D).
7. Dust the patched area with talcum powder to prevent sticking.

STEERING

Handlebar Removal/Installation

1. Remove master cylinder. Leave hydraulic line connected.
2. Slacken clutch cable and disconnect from hand lever.
3. Separate 2 halves of starter switch assembly. Disconnect throttle cable from twistgrip.
4. Remove indicator panel. Follow the 2 wiring harnesses shown in Figure 14A. Disconnect the wires in the harnesses where they terminate in push-on connectors.
5. Remove 4 Allen bolts securing handlebars (Figure 14B) and lift them off.
6. Remove screws securing switch housings to handlebars and pull the wires out.
7. Installation is the reverse of these steps. Adjust clutch free play and throttle cables as described in Chapter Three.

Steering Head Disassembly and Inspection

This procedure lets you disassemble and inspect the steering head components while removing as few unrelated components as possible. Everything can be inspected and replaced except for the steering stem itself. Refer to Figure 15.

15

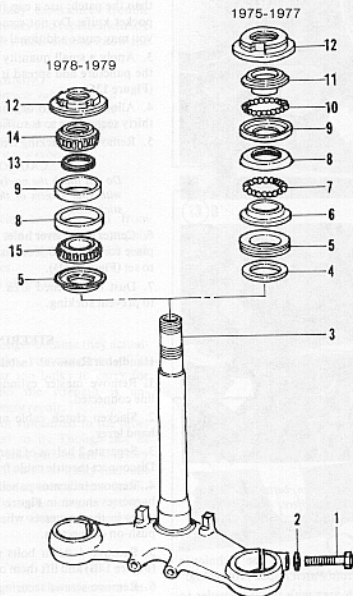

1. Clamp bolt
2. Washer
3. Steering head
4. Washer
5. Dust seal

6. Bottom cone race
7. Balls (19)
8. Lower ball race
9. Upper ball race
10. Balls (18)

11. Top cone race
12. Adjuster nut
13. Seal
14. Upper roller bearing
15. Lower roller bearing

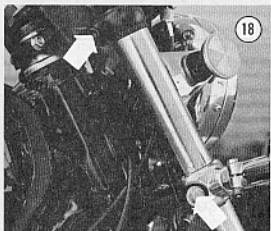
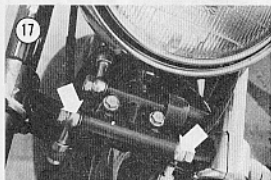
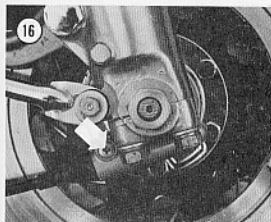

1. Rest bike on centerstand.
2. Loosen speedometer cable setscrew and pull cable out. See Figure 16.
3. Disconnect both front brake lines at the top end. See Figure 17. Plug all exposed ends to prevent brake fluid spillage and to keep dirt and moisture out of the brake system.

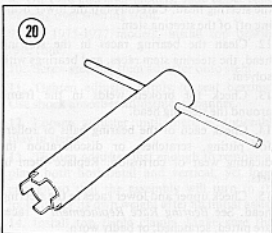
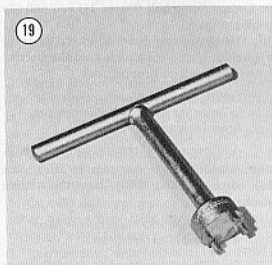

CAUTION

Do not spill brake fluid on painted surfaces as it will ruin the paint. If you do spill it, wash the area immediately with soapy water.

4. Loosen 2 Allen bolts on top triple clamp and 2 clamp bolts on stem. See Figure 18.
5. Slide entire fork/wheel assembly off. If necessary, jack the frame up to gain clearance.
6. Remove 4 Allen bolts securing handlebars and remove handlebar holders.
7. Lay a clean rag over the instruments to protect them and tip the handlebars forward.
8. Remove steering head nut with a special tool. See Figure 19. It is easily improvised. See Figure 20.

9. Loosen clamp bolt (**Figure 21**) and pull top triple clamp off.

10. Loosen steering head adjuster. Refer to **Figure 22**. Have an assistant hold the steering stem to keep it from dropping out.

NOTE: The same hooked spanner used to adjust the rear shock absorbers can be used to loosen the adjuster.

11a. On 1975-1977 models, hold a large pan directly under the steering stem to catch loose ball bearings and carefully lower the steering stem.

NOTE: There are 37 balls total — 18 on the top and 19 on the bottom.

11b. On 1978 and later models, carefully lower the steering stem. Lift the upper bearing out of the steering head. Carefully tap the lower bearing off of the steering stem.

12. Clean the bearing races in the steering head, the steering stem races, and bearings with solvent.

13. Check for broken welds in the frame around the steering head.

14. Check each of the bearing balls or rollers for pitting, scratches, or discoloration indicating wear or corrosion. Replace them in sets.

15. Check upper and lower races in the steering head. See *Bearing Race Replacement* if races are pitted, scratched, or badly worn.

16. Check steering stem for cracks. Check bearing race on stem for pitting, scratches, or excessive wear.

17. Check inside of steering head adjuster (top ball race) for pitting, scratches, or excessive wear.

Bearing Race Replacement

The headset and steering stem bearing races are pressed into place. Because they are easily bent, do not remove them unless they are worn and require replacement. Take old races to dealer to ensure exact replacement.

To remove a headset race, insert a hardwood stick into the head tube and carefully tap the race out from the inside. See **Figure 23**. Tap all around the race so that neither the race nor the

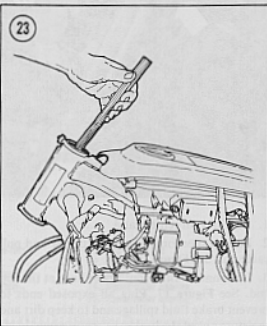
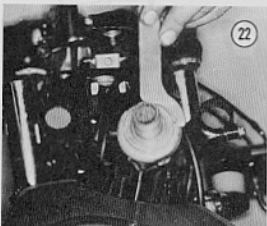

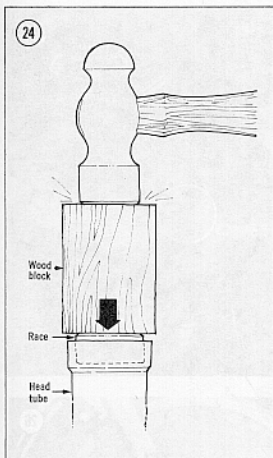

head tube are bent. To install a race, fit it into the end of the head tube. Tap it slowly and squarely in with a block of wood as shown in Figure 24.

NOTE: The upper and lower races are different. Be sure that you install them at the proper ends of the head tube.

To remove the steering stem race, try twisting and pulling it by hand. If it is stuck, carefully pry it up with a screwdriver, working around in a circle, prying a little at a time. To install the race, slide it over the steering stem with the bearing surface pointing up. Tap the race down with a piece of hardwood; work around in a circle so that the race will not be bent.

Steering Head Assembly

Refer to Figure 15 for this procedure.

1. Make sure that steering head and stem races are properly seated.

2. Install washer (1975-1977) and new dust seal over steering stem.

NOTE: Steps 3-5 apply to 1975-1977 models only.

3. Install bottom bearing race cone over steering stem. Slide it down as far as possible.

4. Apply coat of grease to bottom race cone and fit 19 ball bearings around it. The grease will hold them in place.

5. Fit 18 ball bearings into top race in head tube. Grease will hold them in place.

6. On 1978 and later models only, slide lower roller bearing over steering stem and tap it down as far as it will go.

7. Insert steering stem into head tube. Hold it firmly in place.

8. On 1978 and later models, slide upper roller bearing over steering stem.

9. On 1975-1977 models, install top bearing race cone.

10. Screw steering stem adjuster onto stem.

11. Tighten adjuster firmly to seat bearings. Use shock absorber adjustment spanner.

12. Loosen adjuster until there is noticeable play in stem.

13. Tighten adjuster just enough to remove all play, both horizontal and vertical, yet loose enough so that the assembly will turn to the locks under its own weight after an initial assist.

14. Install top triple clamp. Make sure that headlight brackets fit inside rubber mounts on top triple clamp. Tighten clamp bolt to 22-29 ft.-lb. (3.0-4.0 mkg).

15. Install thrust washer and steering head nut. Tighten with special tool. Install rubber cap over nut.

16. Fit handlebars into place. Secure with holders and Allen bolts. Each holder has a center punch at one end; the punches must face up. See Figure 25.

17. Slide the fork tubes into the steering head assembly.

18. Tighten stem clamp bolts just enough to hold forks in place. Tighten Allen bolts on top triple clamp to 22-29 ft.-lb. (3.0-4.0 mkg).

19. Connect brake lines to junction on steering stem.

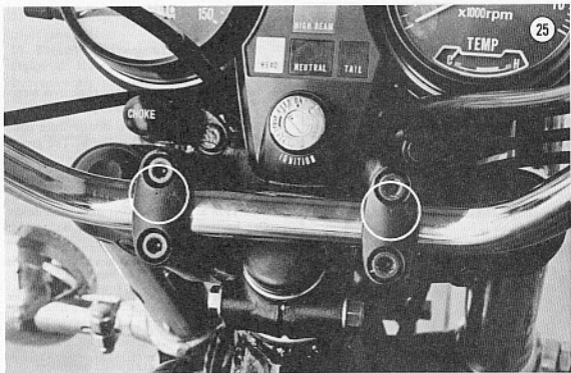

20. Insert speedometer cable and tighten screw.

21. Bleed brakes as described under *Bleeding Brakes*, Chapter Three.

Steering Stem Adjustment

If play develops in the steering stem, it may only require adjustment. However, don't take a chance on it. Disassemble the stem and look for possible damage. Then reassemble and adjust as described in Steps 9-11, *Steering Head Assembly*.

FRONT FORKS

Removal/Installation

1. Remove the front wheel as described under *Front Wheel Removal/Installation*.
2. Remove 2 bolts holding each brake caliper to its fork leg (Figure 26) and lift the calipers off. Tie them up with wire to keep tension off of the brake lines.

NOTE

Insert a piece of wood in each caliper in place of the brake disc. That way if the brake lever is inadvertently squeezed, the

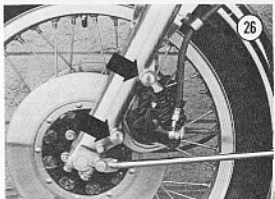

piston will not be forced out of the cylinder. If this does happen, the caliper may have to be disassembled to reset the piston and the system bled. By using the piece of wood, bleeding the brake is not necessary when installing the wheel.

3. Remove the front fender.
4. Loosen the Allen bolt and clamp bolt on the upper and lower triple clamp (Figure 27) and slide forks out.
5. Installation is the reverse of these steps. Tighten Allen bolts to 22-29 ft.-lb. (3.0-4.0

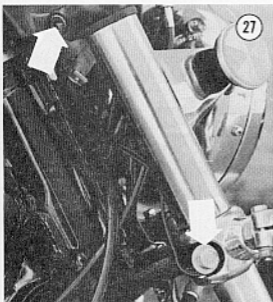

mkg). Tighten lower clamp bolt just enough to hold fork tube.

Disassembly/Assembly

Refer to Figure 28 for this procedure.

1. Hold the fork slider in a vise with soft jaws. Loosen the Allen bolt at bottom of slider (Figure 29). Do not remove it at this time.

NOTE

This bolt has been secured with a sealant and often is very difficult to remove because the damper rod will turn inside the slider. It sometimes can be removed with an air impact driver. If you are unable to loosen it, take the fork assembly to a dealer and have them remove each bolt.

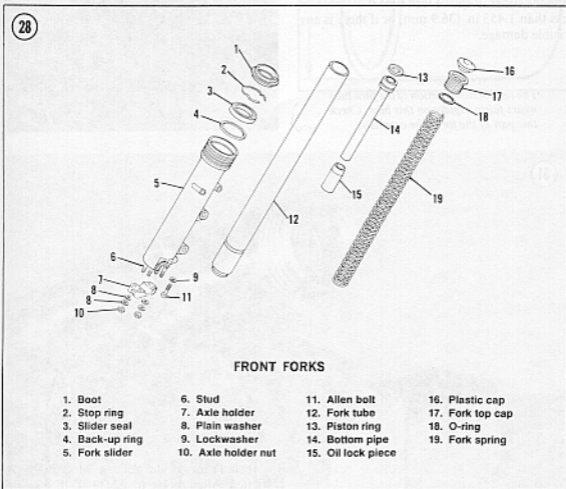

2. Hold the fork tube in a vise with soft jaws. Keep slider end lower than top end.
3. Remove top fork cap with Allen wrench. See Figure 30.
4. Pull fork spring out of fork tube.
5. Remove fork tube from vise and pour fork oil out. Pump fork several times by hand to get most of the oil out.
6. Remove the Allen bolt loosened in Step 1. See Figure 29. Pull the fork tube out of slider.
7. Remove parts 13-15 in Figure 28 from fork slider.
8. Pry dust seal (1, Figure 28) off top of slider.
9. Remove snap ring (Figure 31).
10. Pry seal out of slider. See Figure 32. Be careful not to mar the slider surface.
11. Clean all parts in solvent and dry.
12. Measure fork tube outer diameter with a micrometer at several points where it fits inside the slider. Replace fork tube if diameter is less than 1.453 in. (36.9 mm) or if there is any visible damage.

NOTE

The rear bottom portion of the fork tube wears fairly rapidly on this bike. Check this part of the fork tube carefully.

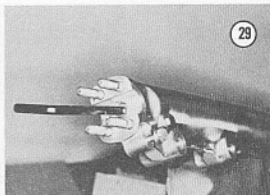

29

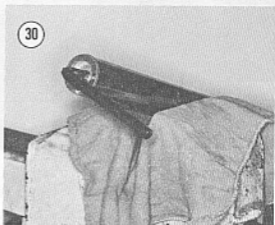

30



31

13. Measure inside diameter of fork slider. Replace if bore is greater than 1.467 in. (37.25 mm) or there is any sign of damage.
14. Measure the uncompressed length of fork spring. Replace if it is less than 19.5 in. (495 mm) on 1975-1977 models or 19.7 in. (500 mm) on models from 1978-1979.
15. Assembly is the reverse of these steps. Use new seals.
16. Apply fresh automatic transmission fluid to the slider seal prior to installation. Install the

slider seal with the seal spring facing down; make sure that it seats squarely and fully in the slider bore. Make a special tool from a piece of pipe with the dimensions shown in Figure 33 to tap the seal down into position. Install fork spring with the closely wound coils at the top.

NOTE

Apply silicone sealant (or Loctite Lock N' Seal) to the thread of the Allen bolt at bottom of slider prior to installation.

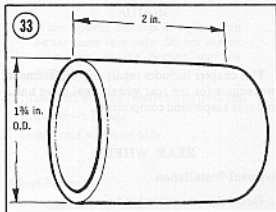
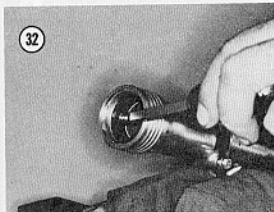

NOTE: If you own a 1980 or later model, first check the Supplement at the back of the book for any new service information.

CHAPTER TEN

REAR SUSPENSION AND FINAL DRIVE

This chapter includes repair and replacement procedures for the rear wheel, final drive unit, and rear suspension components.

REAR WHEEL

Removal/Installation

1. Rest bike on centerstand.
2. Remove lower shock absorber bolts. See Figure 1.
3. Raise the wheel with a block of wood so that the axle is above the muffler.
4. Remove the bolt securing the rear caliper. See Figure 2.
5. Remove cotter pin from axle nut and remove axle nut. See Figure 3.
6. Pull the rear axle out from the left side. See Figure 4.
7. Raise the caliper assembly up and off the brake disc. Move it out of way.

NOTE

Insert a piece of wood in each caliper in place of the brake disc. That way if the brake pedal is inadvertently depressed, the piston will not be forced out of the cylinder. If this does happen, the caliper may have to be disassembled to reset the piston and the system bled. By using the piece of wood, bleeding the brake is not necessary when installing the wheel.

8. Move the wheel to the left to separate it from the final drive splines.

9. Remove the wheel to the rear.
10. Installation is the reverse of the removal steps. Make sure that the wheel hub splines engage with the splines in the final drive unit. Torque axle nut to 58-72 ft.-lb. (8-10 mkg). Align the castellations in the nut with the axle hole and install a new cotter pin. Bend the ends over completely. Tighten the shock absorber bolts to 22-29 ft.-lb. (3-4 mkg) and the caliper bolt to 40-43 ft.-lb. (5.5-6.0 mkg).

Disassembly

Refer to Figure 5 for this procedure.

1. Remove rear wheel as described above.
2. Remove bearing retainer from hub.
3. Pry out seal.
4. Remove 6 nuts and pull off final drive flange.
5. Remove spacer from hub.
6. Insert drift through right side of hub, and tap out left bearing.
7. Tap right bearing out of final drive flange.

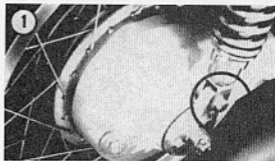

Inspection

1. Clean all parts in solvent.
2. Turn each bearing by hand. Make sure that bearings turn smoothly. Check balls for evidence of wear, pitting, or excessive heat (bluish tint). Replace questionable bearings.
3. Check axle for wear and straightness. Figure 6 shows one method.

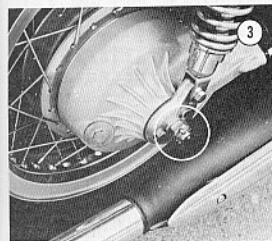
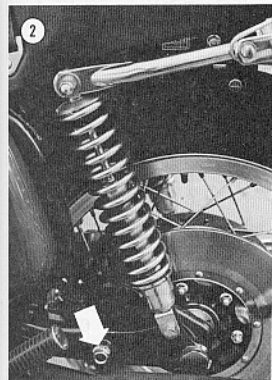

4. Check for bent or broken spokes.
5. Check for rim damage.

Assembly

Refer to **Figure 5** for this procedure.

1. Pack bearings thoroughly with multipurpose grease. Work grease in between balls.
2. Insert spacer.
3. Install left bearing in hub, and right bearing in drive flange with sealed side facing outward.

CAUTION

When tapping bearings into place, tap on the outer race only. Do not tap on inner race or the bearing may be damaged.

4. Install left bearing retainer and dust seal.
5. Install drive flange.
6. Install rear wheel on bike.

Wheel Balancing

An unbalanced wheel can be dangerous. Depending on the degree of unbalance and speed, the rider may experience anything from mild vibration to violent shimmy. In severe cases, the rider can lose control.

Wheels are relatively easy to balance without special equipment. Your dealer has an assortment of balance weights which attach to the spokes. They are crimped on to the light side of the wheel with ordinary gas pliers. See **Figure 7**. Buy a couple of each weight available (**Figure 8**). If undamaged, you can return the unused weights.

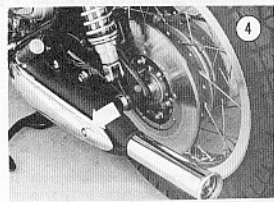

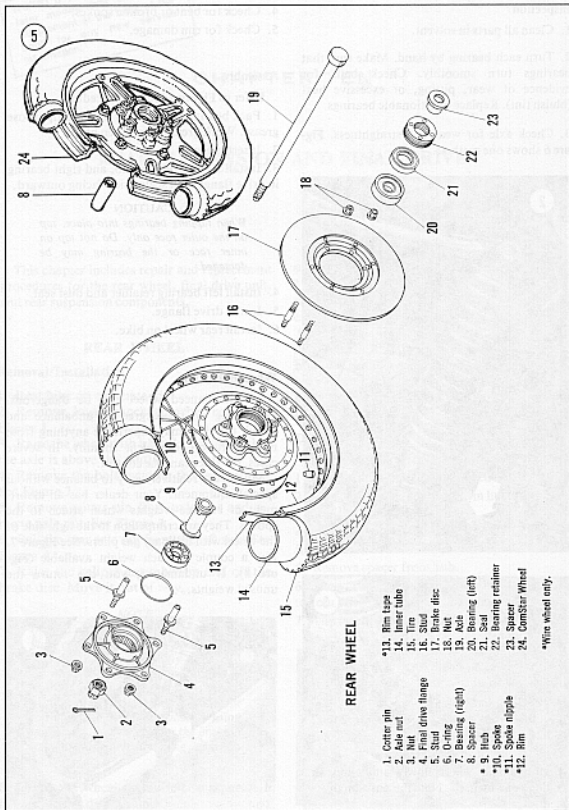

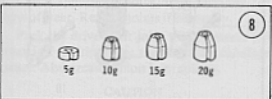
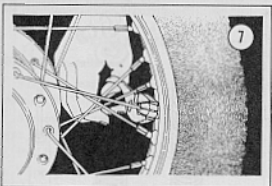
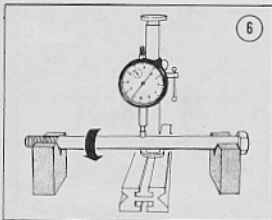

For ComStar wheels, use stick-on weights with self-adhesive made for solid wheels.

Before balancing a wheel, make sure bearings are in good condition and properly lubricated. Use the *Rear Wheel, Disassembly/Inspection/Assembly* procedures in this chapter to be sure. In addition, make sure that the brakes do not drag. The wheel must rotate freely.

1. Rest bike on centerstand.
2. Remove rear wheel.
3. Insert axle in wheel and support ends of axle so that wheel can rotate freely.
4. Rotate rear wheel slowly and allow it to come to rest by itself. Note the position of valve stem.

5. Repeat Step 3 several times. If the valve stem stops at a different position each time, the wheel is balanced. If the valve stem stops near the same position each time, add weight at the 12 o'clock position (light side) until valve stem no longer favors one position when the wheel stops.

6. Install wheel and road test bike on smooth, straight road.

Spoke Adjustment

Spokes loosen with use and should be checked periodically. Follow the *Spoke Adjustment* procedure in Chapter Nine.

TIRE CHANGING

Refer to *Tire Changing*, Chapter Nine for the correct procedure.

WARNING

The rear tire designed for the ComStar wheel is not interchangeable with the tire for the wire wheel. Damage to the tire, rim or inner tube could occur causing a serious accident.

REAR SHOCKS

Removal/Installation

Many accessories such as luggage racks and saddlebags use the upper shock mounting stud. Usually these accessories must be removed first.

1. Rest bike on centerstand and set shock to its softest setting.
2. Remove upper mounting nut and lower mounting bolt. See Figure 9.
3. Pull shock off.
4. Installation is the reverse of these steps.

Disassembly/Assembly

WARNING

Without the proper tool, this procedure can be dangerous. The spring can fly loose, causing injury. For a small bench fee, your dealer can do the job for you.

1. Compress shock as shown in Figure 10 and remove spring seat stops.

2. Release compression.
3. Remove cover and spring from damper unit.
- 4a. On 1975-1977 models, measure free length of spring. It should be 9.75 in. (244mm) or more in length.
- 4b. On 1978 models, measure free length of each spring. Small spring should measure 2.7 in. (69mm) and the larger spring should measure 6.7 in. (175mm).

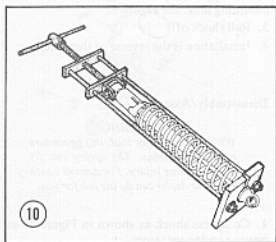
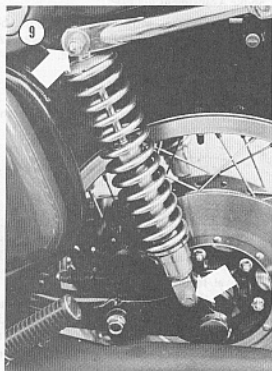

5. Check damper unit for leakage and make sure damper rod is straight.

NOTE: The damper cannot be rebuilt; it must be replaced as a unit.

6. Assembly is the reverse of disassembly. Note order of parts shown in Figure 11.

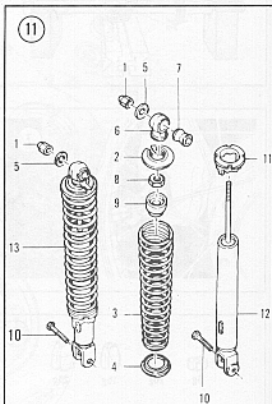

REAR SHOCK ABSORBER

1. Rear shock absorber upper nut
2. Spring upper seat
3. Spring (2-piece since 1978)
4. Spring under seat
5. Washer
6. Eye
7. Rubber bushing
8. Locknut
9. Rubber stop
10. Bolt
11. Preload adjuster
12. Shock body

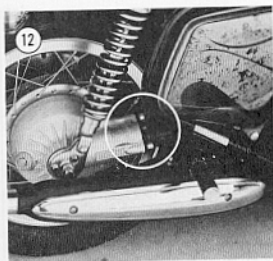

FINAL DRIVE

Removal/Installation

1. Remove rear wheel as described in this chapter.
2. Remove 3 nuts securing final drive to swing arm. See Figure 12.
3. Pull final drive straight back until it is free.
4. Wipe grease from pinion joint (on end of final drive) and drive shaft joint splines.
5. Check splines on both joints carefully for signs of wear. Replace joints if necessary.
6. Pack the drive shaft joint with 2 ounces (56 grams) of multipurpose molybdenum disulfide grease. Also grease pinion joint splines.

CAUTION

This is extremely important on 1975 models without a Zerk fitting on the final drive case. Your dealer can add the fitting to these models.

8. Install the final drive on the swing arm. Do not tighten nuts.
9. Insert rear axle through swing arm and final drive to align the final drive unit. Tighten final drive mounting nuts to 25-33 ft.-lb. (3.5-4.5 mkg) and remove rear axle.
10. Check torque of 6 nuts securing final drive flange to the rear wheel. Torque should be 36-43 ft.-lb. (5-6 mkg).
11. Install rear wheel as described in this chapter. Install the muffler as described in Chapter Six.

Disassembly and Inspection

Although it may be practical for you to disassemble the final drive for inspection, you cannot replace bearings or seals (which require bearing removal) without special tools. If there is trouble in the final drive, it may be best to remove the unit and let the dealer overhaul it as necessary. See Figure 13 for this procedure.

1. Remove final drive as described under *Final Drive Removal/Installation*.
2. Remove drain plug and fill plug. Refer to Figure 14. Pour oil from unit.
3. Remove 8 bolts securing ring gear cover. See Figure 15.
4. Lift ring gear cover out with 2 screwdrivers.
5. Clean the ring gear assembly and the gear case assembly with solvent.
6. Pry the staked area of the pinion nut out to free the nut. See Figure 16.
7. Hold pinion joint splines in a vise with soft jaws and remove the pinion nut. Also slide the pinion thrust washer off.
8. Tap the pinion shaft with a plastic or lead hammer to force the pinion out of its bearing and into the gear case. Remove the pinion joint and pinion.

CAUTION

Do not use a steel or brass hammer or the shaft could be damaged.

9. Slide the O-ring off the pinion shaft. Also slide off the spacer and washer.

CAUTION

The bearings are easily damaged if removed. The following inspection procedures do not require bearing removal. Remove the bearings only if they are defective.

10. Make sure that all bearings are clean.
11. Turn each bearing by hand. Make sure that bearings turn smoothly. Check rollers for evidence of wear, pitting, or excessive heat (bluish tint).
12. If any bearing is questionable, take it to your dealer. He will verify if the bearing is defective and replace it for a small bench fee. Special pullers are required to remove the bearings, and a press must be used to install them.

FINAL DRIVE

1. Bolt
2. Bolt
3. Washer
4. Washer
5. Bushing
6. Right cover
7. O-ring
8. Filler cap
9. O-ring
10. Drain plug
11. Washer
12. Spacer
13. Washer
14. Bearing race
15. Bearing
16. Washer
17. Stud
18. Gear housing
19. Pinion nut
20. Washer
21. Pinion joint
22. Oil seal
23. O-ring
24. Bearing
25. Bearing race
26. Pinion gear
27. Seal
28. Bearing
29. Preload shim
30. Ring gear
31. Bearing
32. Bearing retainer stop
33. Flange bolt
34. Left cover gasket
35. Left cover
36. Oil seal
37. O-ring
38. Bearing retainer
39. Spacer

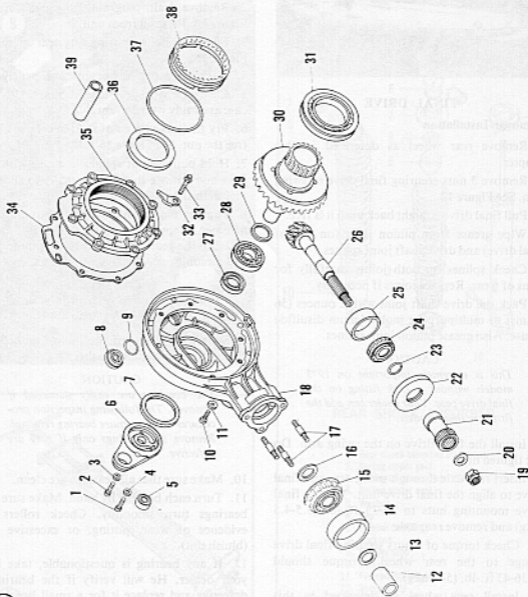

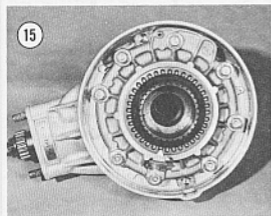
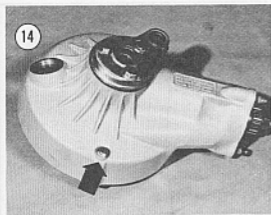
**CAUTION**

The final drive case is very easily damaged by trying to use improvised bearing replacement tools. Take the job to your dealer to avoid costly and unnecessary damage.

13. Check the wear pattern on the ring and pinion teeth. See Figure 17. Check for the following characteristics:

- There should be some clearance between top of teeth and top of pattern.
- There should be no distinct lines indicating high pressure areas.
- Marks on adjoining teeth should be directly opposite each other.
- Both drive and coast patterns should be fairly well centered on teeth.

14. Check teeth on ring and pinion gears. Look for visible wear or damage. Check for chipped or missing teeth.

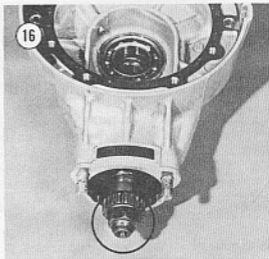
**Assembly**

This procedure assumes that all seals and bearings are in good condition and properly installed. Refer to Figure 13.

- Slide spacer, washer, and O-ring on pinion shaft. See Figure 18.
- Insert pinion into case. Tap it lightly with a plastic mallet to seat it in its bearing.
- Slide the pinion joint onto the pinion shaft. Install the thrust washer and pinion nut. See Figure 18. Tighten the pinion nut to 51-65 ft.-lb. (7.0-9.0 mkg). Make sure that pinion turns smoothly. Stake the nut into the hole in the pinion shaft with a centerpunch. See Figure 16.
- Install the case gasket on the case with a light coat of rubber-based gasket sealer such as Gasegacinch. Do not use sealer on cover side of gasket.

NOTE: The following steps adjust the gear preload. These steps must be followed exactly or the gears will wear prematurely. If the inspection showed satisfactory gear wear patterns, and nothing has been replaced, use the original preload shim and skip Steps 5-12.

- Install original preload shim on ring gear shaft. See Figure 19. A small coating of grease will hold it in place.
- Apply a thin, even coat of lead oxide or Prussian blue to the ring gear teeth.

7. Install the ring gear in the gear case. Tighten case bolts to 17-20 ft.-lb. (2.3-2.8 mkg).
8. Turn pinion shaft several turns in both directions so that the contact pattern of the teeth is pressed into the coating of lead oxide.
9. Remove case bolts and carefully lift ring gear assembly off.
10. Examine the contact pattern on the teeth and check for the characteristics listed under Step 13 of the *Disassembly/Inspection* procedure. Figure 17 shows typical patterns. Your pattern need not be exactly like the illustration to be acceptable.
11. If pattern is not acceptable, purchase different size shims and repeat Steps 5-10 to determine which shim size should be used. Do not use more than one at a time.

NOTE

Shims are available in thicknesses from 1.76 mm to 2.36 mm in 0.04 mm increments.

12. When you have found a shim which produces an acceptable pattern, clean all traces of lead oxide from the gears.
13. Install proper preload shim on ring gear. Hold it in place with a small amount of heavy grease.
14. Apply a light coat of rubber-based sealant (such as Gasegacinch) to the cover gasket.
15. Install ring gear assembly in gear case.
16. Secure case with 8 bolts and tighten them evenly and alternately to 17-20 ft.-lb. (2.3-2.8 mkg). Install the lock tab under the bolt shown in Figure 15.
17. Check backlash as follows. Lay final drive flat on a bench. Mount dial indicator so that the plunger bears on a ring gear tooth through the oil filler hole. The backlash must not exceed 0.25 mm.
18. Install the final drive unit on the swing arm as described under *Final Drive Removal/Installation*.

DRIVE SHAFT

Removal/Installation

1. Remove the rear wheel and final drive units as described in this chapter.
2. Slide drive shaft boot to the rear.

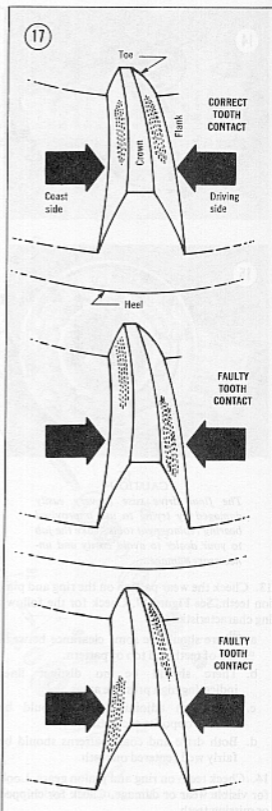

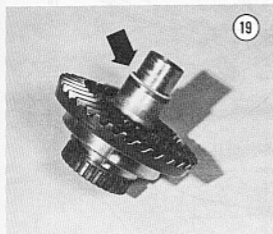
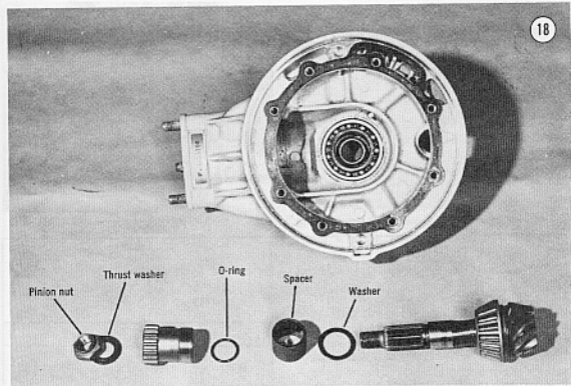

3. Remove snap ring from the front of the drive shaft with 90° snap ring pliers. See Figure 20.
4. Remove the swing arm as described in this chapter.
5. At the rear of the swing arm remove the internal snap ring and slide off the drive shaft coupling.
6. At the front of the swing arm slide out the drive shaft.

7. Installation is the reverse of these steps. Apply a light coat of multipurpose molybdenum disulfide grease to the forward splines to prevent rust. Pack rear drive shaft coupling as described under *Final Drive Removal/Installation*.

SWING ARM

Removal/Installation

Refer to Figure 21 for this procedure.

1. Remove the rear wheel as described under *Rear Wheel Removal/Installation*.
2. Remove bolts securing rear master cylinder and tie master cylinder out of way.

NOTE

Insert a piece of wood in each caliper in place of the brake disc. That way if the brake pedal is inadvertently depressed, the piston will not be forced out of the cylinder. If this does happen, the caliper may have to be disassembled to reseat the piston and the system bled. By using the piece of wood, bleeding the brake is not necessary when installing the wheel.

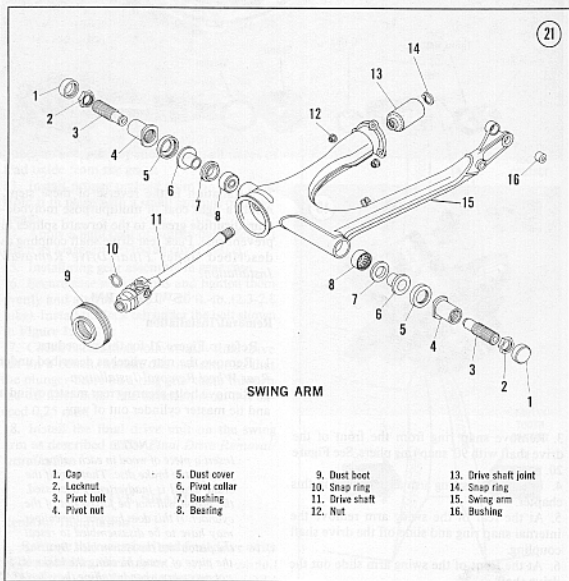
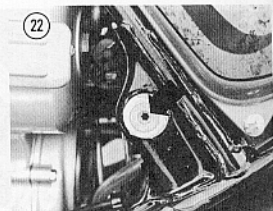
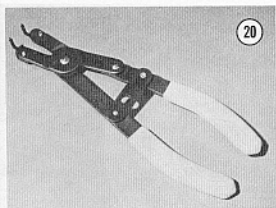

23

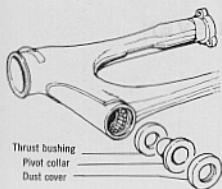

24

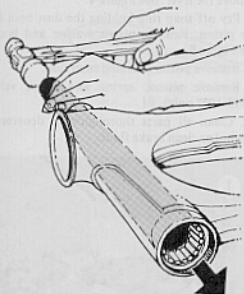
**NOTE**

On models so equipped, do not kink the metal brake line from the master cylinder to the caliper.

- Slide drive shaft boot to the rear.
- Remove snap ring from drive shaft with 90° snap ring pliers. See Figure 20.
- Remove rubber cap from swing arm locknut on each side and loosen the locknuts. See Figure 22.
- Unscrew each swing arm pivot bolt with an Allen wrench. Unscrew each one the same amount and record exactly the number of turns.
- When the swing arm is free of the pivot bolts, slide the swing arm assembly slightly to the left and then to the rear and out.
- Installation is the reverse of these steps. Apply a small amount of grease to the splines on front of drive shaft to prevent rust. Apply a small amount of grease to the ends of each pivot bolt. Screw the pivot bolts in exactly the same number of turns as recorded in Step 6. Tighten the left pivot bolt to 7.25 ft.-lb. (10 mkg) and back out 1/8 turn. Move the swing arm up and down and check for freedom of movement. If there is any binding check the condition of the bearings and replace if necessary. Tighten the locknuts to 58-87 ft.-lb. (8.0-12.0 mkg). Install the rubber caps.

Swing Arm Bearing Replacement

Refer to Figure 21 for this procedure.

- Remove swing arm as described in this chapter.
- Remove dust cover, pivot collar, and thrust washer. See Figure 23.
- Remove bearings by tapping them out from the opposite side. See Figure 24.
- Installation is the reverse of these steps. Lubricate bearings and pivot collar with NLGI-2 grease.

NOTE: If you own a 1980 or later model, first check the Supplement at the back of the book for any new service information.

CHAPTER ELEVEN

BRAKES

The GL-1000 has dual front disc brakes operated by a hand lever, and a single rear disc brake operated by a foot pedal. This chapter describes repair and replacement procedures for all brake components. **Table 1** (end of chapter) provides brake specifications.

FRONT MASTER CYLINDER

Removal/Installation

1. Remove the rear view mirror.
2. Disconnect the hydraulic line from the master cylinder. See **Figure 1**. Plug the end to prevent entry of moisture and dirt.
3. Remove the mounting bolts securing the master cylinder to the handlebars. See **Figure 1**.
4. Installation is the reverse of these steps.
5. Bleed the brakes as described under *Brake Bleeding*, Chapter Three.

Overhaul (1975-1978)

Refer to **Figure 2** for this procedure.

1. Remove the top cover and rubber from the reservoir.
2. Pour remaining brake fluid from the reservoir. Discard it; do not reuse it.
3. Remove 2 screws inside the reservoir (**Figure 3**) and lift the reservoir off. Also remove the plastic seal in the main body.

4. Pry out O-ring from main body.
5. Remove nut on bottom of main body and lift the plate off. Shake out the rubber tubing lever stop. See **Figure 4**.
6. Remove bolt securing lever to body and remove the lever. See **Figure 4**.
7. Pry off snap ring holding the dust boot on the piston. Remove plastic washer and boot. See **Figure 5**.
8. Remove piston retaining snap ring.
9. Remove piston, spring and check valve (1975-1977 only).
10. Clean all parts thoroughly in denatured alcohol or clean brake fluid.

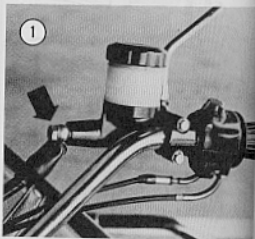

2

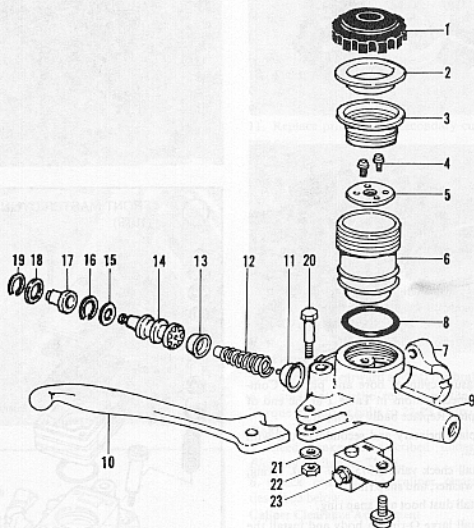

- | | |
|--------------------|-----------------------------|
| 1. Cap | 8. O-ring |
| 2. Diaphragm plate | 9. Body |
| 3. Diaphragm | 10. Lever |
| 4. Screws | 11. Check valve (1975-1977) |
| 5. Reservoir plate | 12. Spring |
| 6. Reservoir | 13. Primary cup |
| 7. Mount | |

- | |
|-------------------------|
| 14. Piston assembly |
| 15. Washer |
| 16. Snap ring |
| 17. Dust boot |
| 18. Washer |
| 19. Snap ring |
| 20. Lever bolt |
| 21. Washer |
| 22. Nut |
| 23. Brake switch (1978) |

**FRONT MASTER CYLINDER
(1975-1978)**

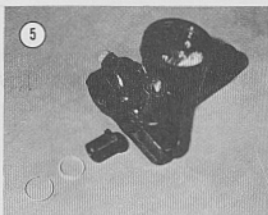
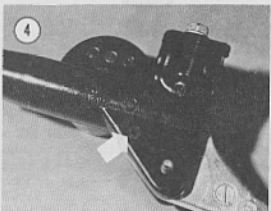

11. Measure cylinder bore and piston. Compare to specifications in **Table 1** at the end of the chapter. Replace badly worn parts.
12. Replace primary and secondary cups with new ones.
13. Install check valve (1975-1977 only), spring, piston, washer, and snap ring.
14. Install dust boot and snap ring.
15. Install large O-ring in body and install the reservoir with circular plates and 2 screws.

Overhaul (1979)

Refer to **Figure 6** for this procedure.

1. Remove the top cover and rubber diaphragm from the reservoir.
2. Pour remaining brake fluid from the reservoir. Discard it; do not reuse it.
3. Lift reservoir body off.
4. Pry out O-ring from main body.
5. Remove bolt securing the lever to the main body, and remove the lever.

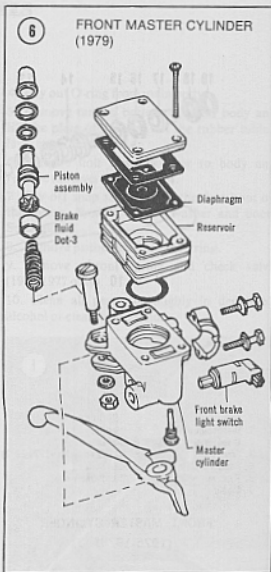

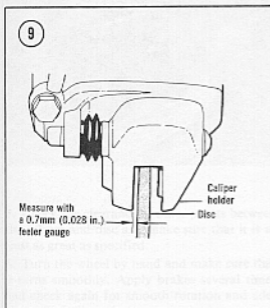
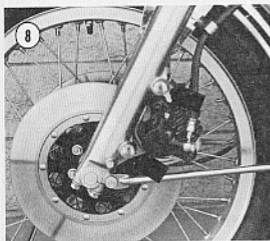
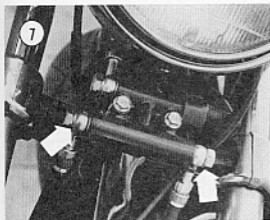

6. Pry off the snap ring holding the dust boot on the piston. Remove the plastic washer and boot.

7. Remove the piston retaining snap ring.

8. Remove the piston and spring.

9. Clean all parts thoroughly in denatured alcohol or clean brake fluid.

10. Measure the cylinder bore and piston. Compare to specifications in **Table 1** (end of chapter). Replace badly worn parts.

11. Replace primary and secondary cups with new ones.

12. Install spring, piston, and snap ring.

13. Install dust boot and snap ring.

14. Install large O-ring in the main body.

15. Install the reservoir, diaphragm, and cover.

FRONT BRAKE CALIPERS

Removal/Installation

1. Disconnect hydraulic line at upper end. See **Figure 7**. Plug the open ends to prevent spills and to keep out moisture and dirt.

2. Remove 2 caliper mounting bolts from fork. See **Figure 8**.

3. Lift caliper rearward and off the brake disc.

4. Installation is the reverse of these steps. Torque mounting bolts to 22-29 ft.-lb. (3.0-4.0 mkg).

5. Bleed brake as described under *Brake Bleeding* in Chapter Three.

6. Check brake disc-to-caliper clearance as described below.

Caliper Clearance Adjustment

1. Rest bike on centerstand.

2. Measure the clearance between the outside surface of the left disc and the rear edge of the left caliper as shown in **Figure 9**. Use a 0.028 in. (0.7mm) feeler gauge.

3. If clearance measured is greater than specified, no adjustment is necessary.

4. If clearance is less than specified, loosen the left axle holder nuts, pull the left fork outward until clearance is correct, leave the feeler gauge in place and tighten the *forward* axle holder nuts to 13-18 ft.-lb. (1.8-2.5 mkg). Then tighten the rear most axle holder nuts to the same torque and remove the gauge.

10

FRONT CALIPER

- | | |
|-------------------------|-----------------------|
| 1. Mounting bolt | 12. Pad set |
| 2. Washer | 13. Support bracket |
| 3. Allen bolt | 14. Inspection window |
| 4. Dust cap | 15. Caliper cover |
| 5. Bleeder valve | 16. Cover bolts |
| 6. Caliper body | 17. Pad shim |
| 7. Piston seal | 18. Pin |
| 8. Piston | 19. Pin |
| 9. Piston boot | 20. Dust cover |
| 10. Boot retaining clip | 21. Boot retainer |
| 11. Spreader spring | |

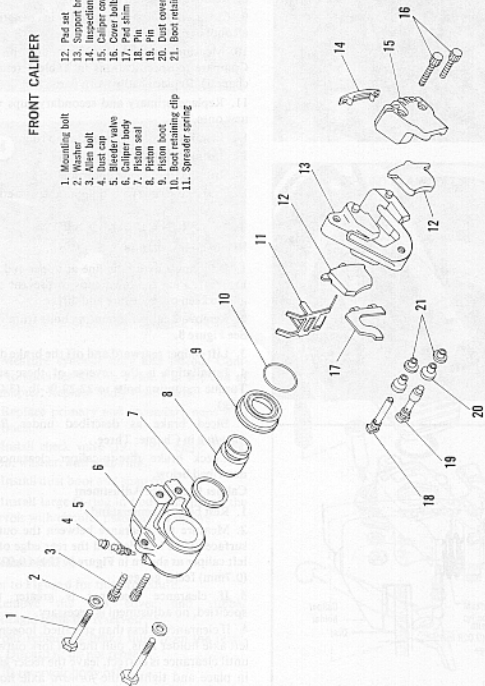

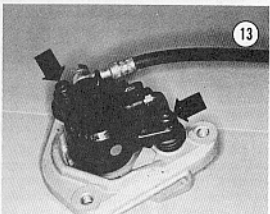
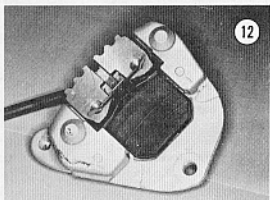
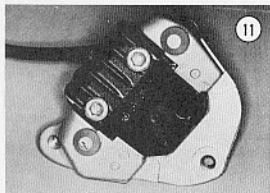

5. Check the clearance at other points between the caliper and disc and make sure that it is at least as great as specified.

6. Turn the wheel by hand and make sure that it turns smoothly. Apply brakes several times and check again for smooth rotation and adequate disc-caliper clearance.

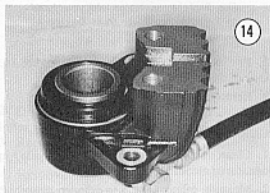

Disassembly

Refer to Figure 10 for this procedure.

1. Remove caliper as described above.
2. Remove 2 Allen bolts from caliper cover (Figure 11) and remove cover.
3. Remove brake pad from cover. If pads are to be reused, mark the pad so that it can be installed in the same place.
4. Remove stabilizing spring and other brake pad. See Figure 12.
5. Remove 2 Allen bolts securing main support bracket. See Figure 13.
6. Remove snap ring and dust seal (Figure 14).
7. Pull brake piston out. See Figure 15.

NOTE: In most cases the piston must be forced out with compressed air; even a bicycle tire pump develops sufficient pressure for this. Hold a shop rag over the piston to keep it from flying out and apply pressure to open end of brake

line. Seal the connection with your hand to keep as much air from leaking as possible.

8. Pry seal from cylinder bore. See **Figure 16**. Do not damage the bore.
9. Remove the brake line from the caliper.

Caliper Inspection

1. Clean all parts except brake pads in denatured alcohol or clean brake fluid.
2. Measure caliper piston-to-cylinder clearance. Clearance should not exceed 0.006 in. (0.15mm). Replace the cylinder if it is larger than 1.506 in. (38.245mm) and piston if smaller than 1.500 in. (38.105mm).
3. Check the cylinder bore seal. Replace it if damaged.
4. Check all parts for signs of wear or damage. Replace if questionable.

Assembly

Refer to **Figure 10** for this procedure.

1. Lubricate the cylinder bore with clean brake fluid and install the seal.
2. Lubricate the piston with clean brake fluid and push it fully into the bore. Do not let it get cocked in the bore or both could be damaged.
3. Install boot and secure with snap ring.
4. Install frame with 2 Allen bolts.
5. Install brake pad closest to piston with metal shim (18, **Figure 10**).
6. Install pad spring.
7. Install other pad and caliper cover. Secure cover with 2 bolts.
8. Install inspection window.
9. Install brake line on caliper. Torque to 22-29 ft.-lb. (3.0-4.0 mkg).

Brake Pad Replacement

Complete disassembly of the caliper is not necessary to replace the brake pads. When replacing the pads, replace all 4 front pads at the same time.

1. Rest bike on centerstand.
2. Remove 2 caliper mounting bolts and lift the caliper-rearward and off the disc.

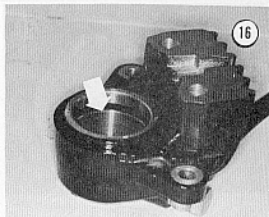

3. Remove 2 Allen bolts from caliper cover and remove cover. See **Figure 11**.
4. Remove both pads and the stabilizing spring.
5. Wipe dust and dirt from inside caliper. Do not damage dust boot. Check for signs of leakage around the boot. If the boot is cracked or there has been leakage, completely disassemble and inspect the caliper as described.
6. Push piston down fully into the bore. Open the bleeder valve if necessary.
7. Install stabilizing spring and new pads. The pad closest to the piston must have the metal shim on the side which bears against the piston.
8. Install caliper cover. Secure with 2 Allen bolts.
9. Install caliper and check disc-to-caliper clearance as described under *Front Caliper Removal/Installation and Caliper Clearance Adjustment*.

FRONT DISC

Replacement

The front discs are secured to the hub with 6 bolts and nuts. See exploded view under *Front Wheel Disassembly*, Chapter Nine.

To remove the discs, remove the front wheel as described in Chapter Nine. Remove the 6 bolts and nuts, and remove the discs.

When installing the discs, torque the mounting nuts to 20-24 ft.-lb. (2.7-3.3 mkg).

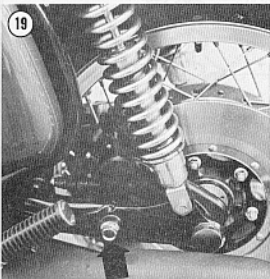

Inspection

The brake discs may be inspected without removing the wheel. Small marks on the disc are not important, but deep radial scratches reduce braking effectiveness and increase brake pad wear. Your dealer has the experience necessary to judge whether a disc is still serviceable or not.

REAR MASTER CYLINDER

Removal/Installation

1. Remove the cotter pin, washer and clevis pin securing the brake pedal to the master cylinder.

NOTE

On 1975-1976 models, it is necessary to remove the rear foot pegs, loosen the clamp on the right muffler and slide the muffler back to allow access to the cotter pin, washer and clevis pin.

2. Disconnect hydraulic line from master cylinder.
3. Remove 2 bolts mounting the master cylinder to the frame. See **Figure 17**.
4. Remove master cylinder.
5. Installation is the reverse of these steps. Bleed the rear brake system as described under *Bleeding Brakes* in Chapter Three.

Overhaul

Refer to **Figure 18** for this procedure.

1. Remove the top cover and rubber from reservoir.
2. Pour remaining brake fluid from the reservoir. Discard it; do not reuse it.
3. Remove 2 screws inside reservoir and lift the reservoir off.
4. Pry out O-ring from main body.
5. Remove clevis fork and rubber boot.
6. Remove snap ring and all internal parts.
7. Clean all parts thoroughly in denatured alcohol or clean brake fluid.
8. Measure cylinder bore and piston. Cylinder bore must not exceed 0.553 in. (14.055mm) and piston must not be smaller than 0.549 in. (13.940mm). Replace badly worn parts.
9. Replace internal parts (13-17, **Figure 18**) with new parts from a standard rebuild kit.
10. Install rubber boot and clevis.
11. Install large O-ring in body and install the reservoir with the circular plate and 2 screws.

REAR BRAKE CALIPER

Removal/Installation

1. Rest bike on centerstand.
2. Remove the rear wheel as described under *Rear Wheel Removal*, Chapter Ten.
3. Remove bolt securing caliper to the frame. See **Figure 19**.
4. Lift caliper out and disconnect the hydraulic line.

- Installation is the reverse of these steps.
- Bleed the brake as described under *Bleeding Brakes*, Chapter Three.

Disassembly

Refer to **Figure 20** for this procedure.

- Remove pad inspection cover.
- Remove 2 Allen bolts on side of caliper.
- Lift off right piston assembly and cover.
- Slide the brake pad assembly out. Mark the pads so that they will be installed in the same position.
- Remove snap ring and dust boot from one piston. Pull the piston out. Use pliers, but protect the piston from the plier jaws with a thick shop rag. Do not mar the piston or it must be replaced.

NOTE: If you cannot pull the piston out, force it out with compressed air. To do this, plug all openings except one (the bleed valve on the cover and the hydraulic line connection on the main body). Apply air pressure to the remaining opening and force the piston out; even a bicycle tire pump delivers enough pressure for this. Protect your hand with several layers of shop rags and hold it over the piston to keep it from flying out.

- Repeat Step 5 for the other piston.
- Pry the seal from each cylinder bore. Do not damage the bore.

Caliper Inspection

- Clean all parts except brake pads in denatured alcohol or clean brake fluid.
- Measure cylinder bore and piston diameter. Compare to specifications in **Table 1** (end of chapter). Replace badly worn parts.
- Check cylinder bore seals. If damaged, replace them. Better yet, use new seals during assembly as a matter of course.
- Check all parts for signs of wear or damage. Replace any questionable parts.

Assembly

Refer to **Figure 20** for this procedure.

- Lubricate the cylinder bores with clean brake fluid and install the seals.

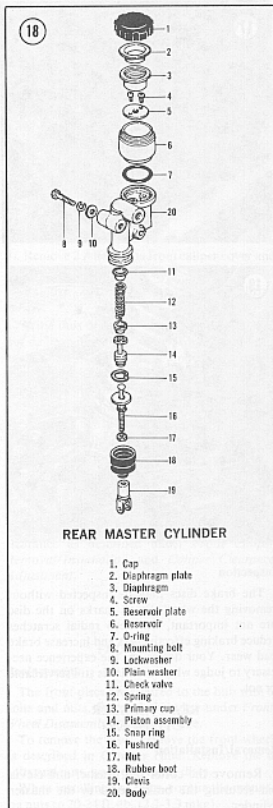

20

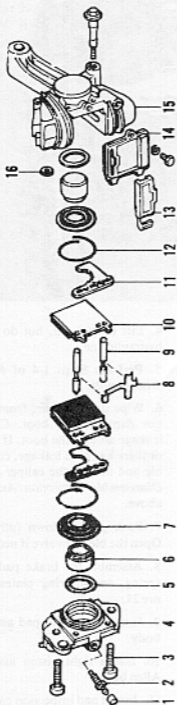

REAR CALIPER

1. Dust cap
2. Bleeder valve
3. Mounting bolt
4. Caliper
5. Piston seal
6. Piston
7. Piston dust boot
8. Spreader spring
9. Pin
10. Pad set
11. Pad shim
12. Boot retainer
13. Inspection window
14. Pad cover
15. Caliper
16. Seal

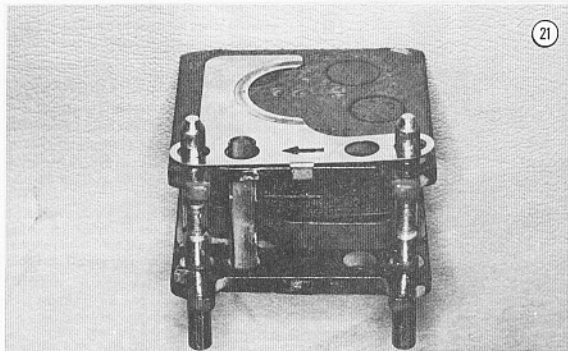

2. Lubricate the pistons with clean brake fluid and push them fully into their respective bores. Do not let them get cocked in the bore; the bore could be damaged.
3. Install boots and secure with snap rings.
4. Assemble the brake pads, 2 pins, spreader spring, and bearing plates as shown in **Figure 21**.
5. Install the brake pad assembly in the main body.
6. Install right piston assembly and cover and tighten Allen bolts.
7. Install pad inspection cover.
4. Lift caliper out, but do not disconnect the hydraulic line.
5. Perform Steps 1-4 of *Rear Brake Caliper Disassembly*.
6. Wipe dust and dirt from inside caliper. Do not damage dust boot. Check for signs of leakage around the boot. If the boot is cracked or there has been leakage, completely disassemble and inspect the caliper as described in the *Disassembly/Inspection/Assembly* procedures above.
7. Push pistons down fully into their bores. Open the bleeder valve if necessary.
8. Assemble the brake pads, 2 pins, spreader spring, and bearing plates as shown in **Figure 21**.
9. Install the brake pad assembly in the main body.
10. Install right piston assembly and tighten Allen bolts.
11. Install pad inspection cover.
12. Install caliper and rear wheel. Bleed brakes as described under *Bleeding Brakes*, Chapter Three.

Brake Pad Replacement

Complete disassembly of the caliper is not necessary to replace the brake pads. When replacing the pads, replace both pads at the same time.

1. Rest bike on centerstand.
2. Remove rear wheel as described under *Rear Wheel Removal*, Chapter Ten.
3. Remove bolt securing caliper to frame. See **Figure 17**.

REAR DISC

Inspection

Replacement

To remove the rear disc, remove the wheel as described under *Rear Wheel Removal*, Chapter Ten. Remove 6 nuts securing the disc to the hub. When installing the disc on the hub, torque the nuts to 20-24 ft.-lb. (2.7-3.3 mkg).

The brake disc may be inspected without removing the wheel. Small marks on the disc are not important, but deep radial scratches reduce braking effectiveness and increase pad wear. Your dealer has the experience necessary to judge whether a disc is still serviceable or not.

See Table 1, on the following page, for brake specifications.

Table 1 BRAKE SPECIFICATIONS

	New in. (mm)	Service Limit in. (mm)
Front master cylinder (1975-1978)		
Bore	0.6874-0.6891 (17.460-17.503)	0.6896 (17.515)
Piston diameter	0.6857-0.6868 (17.417-17.444)	0.6850 (17.400)
Front master cylinder (1979)		
Bore	0.6248-0.6265 (15.870-15.913)	0.6270 (15.925)
Piston diameter	0.6231-0.6242 (15.827-15.854)	0.6224 (15.815)
Rear master cylinder		
Bore	0.5511-0.5528 (14.000-14.043)	0.5533 (14.055)
Piston diameter	0.5495-0.5505 (13.957-13.984)	0.5488 (13.940)
Front caliper		
Bore	1.5031-1.5051 (38.18-38.23)	1.5057 (38.245)
Piston diameter	1.5005-1.5018 (38.115-38.148)	1.5001 (38.105)
Rear caliper (1975-1977)		
Bore	1.5031-1.5051 (38.18-38.23)	1.5057 (38.245)
Piston diameter	1.5005-1.5018 (38.115-38.148)	1.5001 (38.105)
Rear caliper (1978-on)		
Bore	1.6870-1.6890 (42.85-42.90)	1.6900 (42.915)
Piston diameter	1.6840-1.6860 (42.772-42.822)	1.6830 (42.757)
Front discs (1975-1977)		
Thickness	0.2322-0.2401 (5.9-6.1)	0.1968 (5.0)
Runout	0.0-0.002 (0.0-0.05)	0.012 (0.3)
Front discs (1978-on)		
Thickness	0.1890-0.2050 (4.8-5.2)	0.1570 (4.0)
Runout	0.0-0.002 (0.0-0.05)	0.012 (0.3)
Rear disc		
Thickness	0.2716-0.2795 (6.9-7.1)	0.2362 (6.0)
Runout	0.0-0.002 (0.0-0.05)	0.012 (0.3)

NOTE: If you own a 1980 or later model, first check the Supplement at the back of the book for any new service information.

CHAPTER TWELVE

FRAME AND REPAINTING

The frame does not require periodic maintenance. However, all welds should be examined immediately after any accident, even a slight one.

This chapter describes procedures from completely stripping and inspecting the frame. In addition, recommendations are provided for repainting the stripped frame.

This chapter also includes procedures for the kickstand, centerstand, and footpegs.

KICKSTAND (SIDE STAND)

Removal/Installation

Refer to Figure 1.

1. Support bike on centerstand.
2. Disconnect kickstand return spring from kickstand.
3. Unbolt kickstand from frame.
4. Installation is the reverse of these steps.

CENTERSTAND

Removal/Installation

1. Support bike on kickstand
2. Remove muffler as described in Chapter Six.
3. Disconnect stand return spring.
4. Remove the cotter pin on the end of centerstand shaft.

5. Loosen shaft clamp bolts.
6. Slide shaft out and remove stand.
7. Installation is the reverse of these steps. Use a new cotter pin. Fill shaft with grease.

CAUTION

Do not overtighten clamp bolts.

FOOTPEGS

Front Removal/Installation

Virtually every part of the front footpegs is a replacement part. If a part requires replacement, remove the entire footpeg from the frame by removing the single mounting nut or bolt.

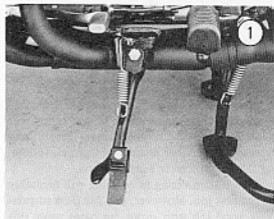

See **Figure 2**. Replace damaged part and re-mount footpeg.

Rear Removal/Installation

To remove footpeg alone, remove cotter pin and pivot pin. See **Figure 3**. To remove footpeg and mounting bracket, remove muffler mounting bolt. See **Figure 3**. When installing mounting bracket, make sure that you align the tab with the locating hole.

STRIPPING THE FRAME

1. Remove the fuel tank, seat, and battery. Disconnect negative terminal *first*.
2. Remove engine as described in Chapter Four.
3. Remove front wheel, steering, and suspension as described in Chapter Nine.
4. Remove rear wheel and suspension components. See Chapter Ten.
5. Remove lighting and other electrical equipment. Remove wiring harness. See Chapter Seven.
6. Remove the kickstand and centerstand.
7. Remove bearing races from steering head tube with a wooden drift. See Chapter Nine.
8. Check the frame for bends, cracks, or other damage, especially around welded joints and areas which are rusted.
9. Assembly is the reverse of these steps.

PAINTING THE FRAME

Strip *all* components from the frame. Thoroughly strip all old paint. The best way is to have it sandblasted down to bare metal. If this is not possible, you can use a liquid paint remover and steel wool.

When the frame is down to bare metal, have it inspected for hairline and internal cracks. Magnafluxing is the most common process.

Spray one or two coats of primer as smoothly as possible. Use a fine grade of wet sandpaper to remove flaws. Carefully clean the surface, then spray on either lacquer or enamel, following the manufacturer's instructions.

A shop specializing in painting will probably do the best job. However, you can do a surprisingly good job with spray can paint using this



trick. First, shake the can thoroughly — at least as long as stated on the can. Then immerse the can upright in a pot or bucket of *warm* water (not over 120°F).

WARNING

Higher temperature could cause the can to burst.

Leave the can in for several minutes. When thoroughly warmed, shake the can again and spray the frame. Several light mist coats are better than one heavy coat.

REPAINTING

The GL-100 is unique in that the bike can be ridden while all paintable covers are at the paint shop. All paintable covers are easily removed.

1. Remove side covers. See **Figure 4**. These are plastic.

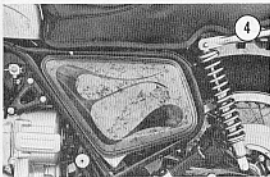

4

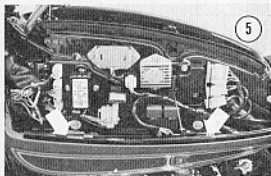

5

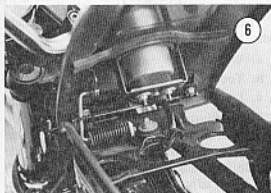

6

2. Swing pod side covers down. Disconnect stop wire and remove hinge pin to lift off covers. See Figure 5. These are made of fiberglass.

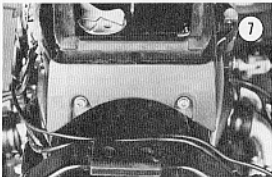

7

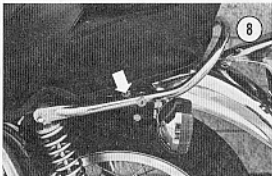

8

3. Remove metal top pod cover. See Figure 6.
4. Remove 2 Phillips screws securing small metal piece at rear of pod. See Figure 7.

NOTE: These screws are easier to remove after removing seat.

SEAT REMOVAL/INSTALLATION

1. Remove 2 bolts securing rear of seat. See Figure 8.
2. Lift rear of seat and disconnect it from front mount.
3. Installation is the reverse of these steps.

CHAPTER THIRTEEN

SIDECAR OPERATION

The Gold Wing has a number of characteristics which make it well suited to sidecar service. There is plenty of power for effortless cruising at any legal speed even when fully loaded with passenger and camping gear. Furthermore, the smooth, quiet engine is appreciated by the passenger who must sit with the engine very close by.

This chapter describes a number of modifications which make the Gold Wing perform even better with a sidecar. Some of the modifications make the bike unsuitable for solo work so you must decide whether the sidecar is a permanent or occasional addition. Of course, all the modifications are easily removed if you should decide to restore the bike to solo use.

INSTALLATION

There are many middle to heavyweight sidecars which can be mounted on the Gold Wing. Some use universal mounts, while others require welded attachment points on the bike frame. Regardless of the mounting method, alignment between bike and sidecar must be properly adjusted and the mounts must be rigid enough to maintain this alignment under all conditions of load and cornering. The information in this section assumes the sidecar is mounted on the right

side of the bike for countries where vehicles operate on the right side of the road. For operation on the left side of the road, mount the sidecar on the left side.

There are 3 basic adjustments to be made when installing a sidecar:

- a. Wheel lead
- b. Toe-in
- c. Lean

These adjustments must be made with the rig resting on a flat, level floor. The sidecar frame must remain horizontal front to back and side to side. Once adjusted, good mounts will maintain these adjustments for a very long time. However, since they affect handling so much, it is wise to check them every 3,000 miles. You should also check them after traveling over very poor roads, hitting a curb or similar obstruction, or after any collision, however mild.

Wheel Lead

Most sidecars are mounted so that the sidecar axle is 8-12 inches ahead of the bike's rear axle. See **Figure 1**. There are exceptions, particularly the Harley-Davidson which has both axles even. The sidecar manufacturer or dealer can suggest how much lead is necessary. Wheel lead minimizes the rig's tendency to pitch forward during hard left-hand turns. When this occurs,

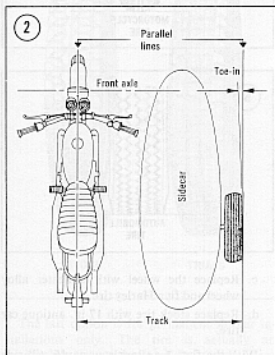
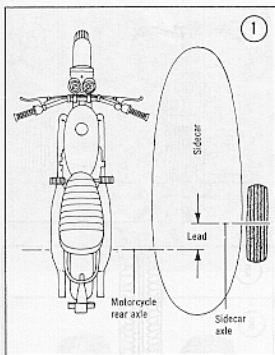

the rear wheel loses traction. In severe cases, the bike could flip right over the sidecar, but the driver would have to be going far faster than any reasonable person would dare.

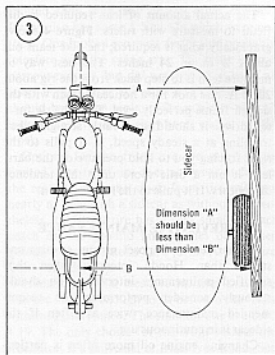

Toe-in

In order for the rig to track straight, the sidecar should be rigged with a small amount of toe-in, that is, the sidecar wheel points slightly toward the bike. See Figure 2. Without toe-in, the rig tends to pull to the right and the rear tire wears much faster.

To measure toe-in you will need a 6-7 ft. 2x4 with at least one true edge. Have an assistant hold the true edge flat against the sidecar tire. See Figure 3. Measure from the inside edge of the board to the centerline of each rim; hook a tape measure over a spoke nipple. The distance measured at the front should be $\frac{1}{4}$ -1 in. less than at the rear. Adjust the mounting clamps as necessary.

Lean

The bike may be leaned out or leaned in to compensate for severe pulling to the right or left. The amount of lean depends on a number of factors:

- Road camber
- Bike weight and load
- Sidecar weight and load

The actual amount of lean required is difficult to measure with rulers. **Figure 4** shows graphically what is required; the bike leans out about $\frac{1}{4}$ in. in 24 inches. The best way to measure lean is to step back from the rig about 20-25 ft. and look for a noticeable lean with the sidecar frame perfectly level. Take the rig for a test drive. It should track fairly straight when traveling at a steady speed. If it pulls to the right forcing you to hold pressure on the bars, lean it out a little more until this tendency disappears. If it pulls to the left, lean it in.

PREVENTIVE MAINTENANCE

Sidecar service imposes greater stresses and strains than Honda intended when they specified maintenance intervals. You should seriously consider performing the recommended maintenance twice as often if the sidecar is in continuous use.

Changing engine oil more often is particularly important. Change oil at least every 1,500 miles. The oil filter can be changed every 3,000 miles, but for \$1 extra it is false economy not to change it at every oil change.

TIRES

A motorcycle tire is designed to operate with a bike heeled well over on either side. The tread wraps around the sidewall to some extent to provide traction in corners. See **Figure 5**. When you add a sidecar, the bike no longer heels over during cornering. Therefore, the tires should have a flat tread like an automobile tire. See **Figure 6**.

Tire selection depends on a number of factors such as how serious you are about sidecars and how much you are willing to spend. If the sidecar is used only occasionally, and the bike is also used solo, you are limited to motorcycle tires. If the sidecar is a permanent addition, most motorcycle tires are out of the question. All the wear is in the center so that they wear flat very rapidly. The rounded tread is wasted.

There are several options for rear tires:

- Retain the stock tire and live with the flat wear and low tire mileage.
- Relace the wheel with the 16 in. rim and fit a Harley tire.

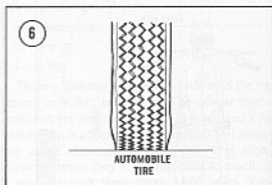
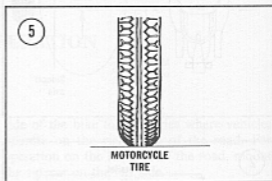
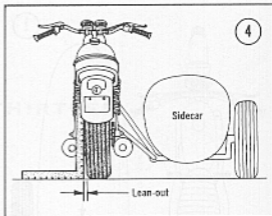

- Replace the wheel with a Lester alloy wheel and fit a Harley tire.
- Replace stock tire with 17 in. antique car tire.

With the first 3 options you could still ride the bike solo. As mentioned before, the stock tire wears rapidly in the center, and at \$35-up it is expensive. The Harley tire has a flatter tread, and wears longer in sidecar service than the stock tire; it costs about the same, though.

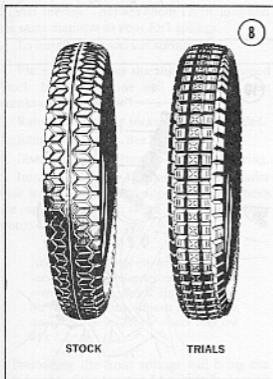
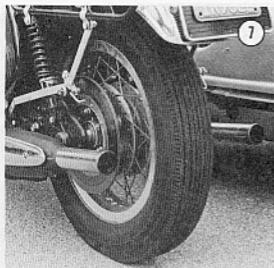

The last option is for permanent sidecar installations only. The tire is actually an automobile tire, with a very flat tread. Lucas Engineering, Culver City, California sells a B.F. Goodrich 4.50 x 17 4-ply rayon tire which mounts on the stock GL-1000 rim and uses the stock inner tube. See Figure 7. With this tire, there is actually a larger contact patch on the

ground than with any of the other options. Lucas also has some 5.50 x 17s which were not tried. One looked too wide and would probably interfere with the swing arm. The other looked narrow enough, but did not appear to be of as good a quality as the 4.50 x 17. The reader should be on the lookout for other 16 and 17 inch tires available elsewhere which would work.

Options for the front tire are much more limited. The front tire does not wear as fast as the rear, so that the stock front tire will last nearly as long with a sidecar as without. Nevertheless, the stock tire has a very small contact patch on the ground and washes out rather quickly on moderate to hard turns. A wider tire helps considerably.

There are no flat tread 19 in. tires available that are narrow enough to fit between the forks without interference. The smallest one is a 6.00 x 19. The only choice for the front besides the stock tire, is a universal or trials type tread. See Figure 8. Either a 3.50 or 4.00 will fit fine. The tread is not flat, but it is wider and flatter than the stock tire.

Many sidehackers use universal or trials type tires on the rear as well as the front. Unfortunately, none is available for a 17 in. rim wide enough for the GL-1000.

WIRE WHEELS

Sidecar service imposes side loads that the stock wheels were never intended to handle. After a short time the spokes loosen and continually require tightening. There are several choices for wheels:

- Retain stock rims and spokes
- Relace stock rims with heavier spokes
- Replace stock wheels with alloy wheels

If the sidecar is only an occasional addition, and the outfit is never loaded very heavily, you can get away with the stock rims and spokes. Check tension at least every 500 miles, and tighten when necessary.

If the sidecar is permanent or you load it heavily, have the wheels relaced with 8 gauge spokes. This costs about \$30 a wheel, but it is money well spent. If you are replacing the stock 17 in. rim with a 16 in. (Harley) rim, have it

laced on with the heavier spokes, usually at no extra cost.

If you are really serious, replace the stock wire wheels with alloy wheels. This can be expensive (\$350 and up), but you will never again have to worry about wheel loads. Lester Tire and Wheel Co. in Ohio makes a set which bolts right on the GL-1000 with the stock hardware and brakes. Furthermore, the rear wheel is 16 in. so you can use a Harley tire.

You could also investigate replacing the wheels with late-model Honda Comstars.

FRONT SUSPENSION

The stock front suspension sags and bottoms out with the weight of the sidecar. This is aggravated even more if you have a fairing, particularly one with storage pockets.

The stock suspension has another problem. It was designed with a large amount of trail which makes steering rather heavy. This is not much of a problem with a solo bike which is steered by shifting your weight. However, in sidecar service, steering must be done by moving the handlebars and steering is excessively heavy for some drivers.

Modifications to Stock Suspension

The modifications in this section will help the dampening and springing qualities of the stock suspension considerably for sidecar service. Unfortunately, nothing can be done to the stock suspension to lighten the steering pressure. If the pressure is more than you are willing to tolerate, consider the Bingham leading link suspension described in the next section.

There are several ways to cure the sag problem. The easiest way is to preload the stock springs. This raises the front end similar to the way you raise the rear end with adjustable shocks. Another solution, though more costly, would be to replace the front springs with heavier ones.

The stock front springs can be preloaded with solid spacers. See Figure 9. Cut spacers from 1 1/2 in. OD steel pipe or solid stock. Softer metals may chip causing rapid fork wear. Try

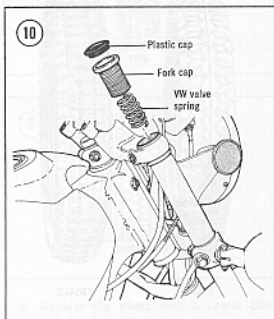
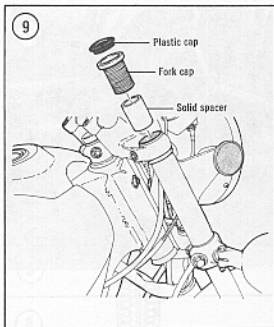

different spacer lengths to get as much preload as you need. With the bike loaded normally, the forks should compress about one inch. Select your spacer length to achieve this.

Instead of solid spacers, you can use Volkswagen engine valve springs. See Figure 10. Some VW's have 2 springs per valve; a small inner spring and a larger outer spring. Get

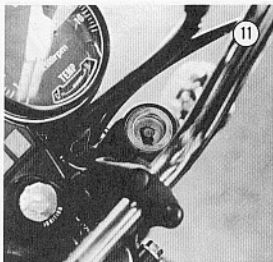

2 outer springs. They are about 1 1/4 in. long and the same diameter as your fork springs.

To install the spacers or springs:

1. Place a jack under the engine. Use a wood block between engine and jack to protect crankcase.
2. Raise jack until the forks are fully extended.
3. Remove fork caps. See Figure 11.
4. Insert spacer or spring on top of fork spring.
5. Install fork caps. This sounds much easier than it is. It takes quite a lot of force to push the caps down and get the threads started. Ugly words may help.

NOTE: The O-rings on the fork caps are very easily damaged even without preload spacers. Buy 2 before starting the job just in case. Honda parts books do not list them; tell the dealer they are 28 x 2.3mm.

Preloading the front springs will bring the ride height of the front end back up, but it will not change the spring rate. The only way to change the stiffness of the front forks is to replace the fork springs with heavier (stiffer) springs. There should be a noticeable reduction in front end dive, sag, and bottoming with 10-20% stiffer fork springs.

Dampening characteristics of the stock forks can be improved by substituting a heavier fork oil. Several manufacturers make special fork

oils from SAE 5 to SAE 40 or 50. The stock oil recommendation is SAE 5. SAE 10 or even 20 will provide better dampening; heavier oil may blow the fork seals. Change the oil as described in Chapter Three, *Changing Front Fork Oil*.

Steering Damper

A steering damper is not necessary with the stock GL-1000. In fact, it makes low speed steering even harder. If you take your hands off the bars at low speed, the front wheel develops a hard wobble, but if you keep your hands on the bars where they belong there is no problem. Before buying a steering damper to cure a wobble, make sure that the steering head bearings are properly adjusted. In most cases they are adjusted too loosely. For adjustment procedure, see Chapter Nine, *Steering Head Assembly*, Steps 9-11.

Leading Link Suspension

The leading link suspension used on many bikes until the late 50's has fallen out of favor with motorcycle manufacturers. This suspension is simple, rigid, and effective. However, it is more costly to manufacture and not as neat in appearance as telescopic fork suspensions.

Doug Bingham, Side Strider, Inc., and Motorvation, Inc., manufacture a leading link suspension specifically for the Gold Wing. See Figure 12. These suspensions fit into the existing triple clamps in place of the stock forks. No welding or other modifications are necessary. The stock wheel and brakes are retained.

The leading link suspension set-up for sidecar use reduces the trail. This makes steering much quicker and easier. In fact it is so effective that some drivers may want to add a steering damper to provide more road "feel."

There is another advantage to installing a leading link suspension. The unit comes with 2 adjustable shock absorbers. The front end is easily adjusted by preloading the shock absorber springs in the same manner as the rear shock absorbers. See Figure 13.

The test bike used for this chapter uses 130 lb. S&W springs on the suspension. They may

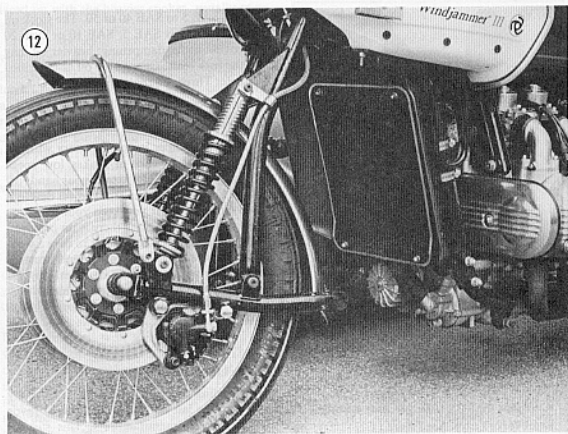

be a little stiff for some drivers, but they seem about right for a fully loaded touring hack with 2 people. They also prevent front end dive on hard braking.

If the ride is too stiff, you can get a smoother ride with 110 lb. springs. These are available from Arnaco or S&W through your dealer. Considering the weight of the Gold Wing, don't get any lighter than 110 lb. springs.

REAR SUSPENSION

The stock shock absorbers and springs are pitifully unable to cope with a sidecar. The rear end sags badly even with the weight of the driver. During moderate to hard right-handers, the shocks bottom hard. Better shocks and stiffer springs change handling dramatically.

Any of the better quality motorcycle shocks will work well. Both Arnaco and Koni shocks

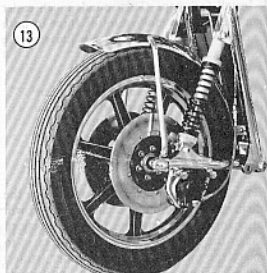

were tried. With Arnaco shocks, dampening is adjustable without disturbing the shock mounting. Koni shocks must be removed from the

bike, then the spring must be removed from the shock to adjust dampening. Since a touring bike usually has saddlebags and other accessories which must be removed to reach the shocks, and since a touring bike operates under a variety of load conditions from driver only to

fully loaded, the Arnaco shocks are a good choice.

Regardless of the shocks selected, use 150 lb. S&W springs or you will have the same sagging you had with the stock springs. Most shock manufacturers don't provide springs heavier than about 110lb.

FIGURE 1. The Arnaco shocks are a good choice.

1980 AND LATER SERVICE INFORMATION

FIGURE 2. The Arnaco shocks are a good choice.

Engine type	1980-1981 1200 cc, 4-cylinder 1982-1983 1200 cc, 4-cylinder 1984-1985 1200 cc, 4-cylinder 1986-1987 1200 cc, 4-cylinder 1988-1989 1200 cc, 4-cylinder
Ignition	1980-1981 1200 cc, 4-cylinder 1982-1983 1200 cc, 4-cylinder 1984-1985 1200 cc, 4-cylinder 1986-1987 1200 cc, 4-cylinder 1988-1989 1200 cc, 4-cylinder
Lubrication	1980-1981 1200 cc, 4-cylinder 1982-1983 1200 cc, 4-cylinder 1984-1985 1200 cc, 4-cylinder 1986-1987 1200 cc, 4-cylinder 1988-1989 1200 cc, 4-cylinder
Transmission	1980-1981 1200 cc, 4-cylinder 1982-1983 1200 cc, 4-cylinder 1984-1985 1200 cc, 4-cylinder 1986-1987 1200 cc, 4-cylinder 1988-1989 1200 cc, 4-cylinder
Final reduction ratio	1980-1981 1200 cc, 4-cylinder 1982-1983 1200 cc, 4-cylinder 1984-1985 1200 cc, 4-cylinder 1986-1987 1200 cc, 4-cylinder 1988-1989 1200 cc, 4-cylinder
Steering system	1980-1981 1200 cc, 4-cylinder 1982-1983 1200 cc, 4-cylinder 1984-1985 1200 cc, 4-cylinder 1986-1987 1200 cc, 4-cylinder 1988-1989 1200 cc, 4-cylinder
Battery	1980-1981 1200 cc, 4-cylinder 1982-1983 1200 cc, 4-cylinder 1984-1985 1200 cc, 4-cylinder 1986-1987 1200 cc, 4-cylinder 1988-1989 1200 cc, 4-cylinder
Alternator	1980-1981 1200 cc, 4-cylinder 1982-1983 1200 cc, 4-cylinder 1984-1985 1200 cc, 4-cylinder 1986-1987 1200 cc, 4-cylinder 1988-1989 1200 cc, 4-cylinder
Spring order	1980-1981 1200 cc, 4-cylinder 1982-1983 1200 cc, 4-cylinder 1984-1985 1200 cc, 4-cylinder 1986-1987 1200 cc, 4-cylinder 1988-1989 1200 cc, 4-cylinder
Swing beam angle	1980-1981 1200 cc, 4-cylinder 1982-1983 1200 cc, 4-cylinder 1984-1985 1200 cc, 4-cylinder 1986-1987 1200 cc, 4-cylinder 1988-1989 1200 cc, 4-cylinder
Tire	1980-1981 1200 cc, 4-cylinder 1982-1983 1200 cc, 4-cylinder 1984-1985 1200 cc, 4-cylinder 1986-1987 1200 cc, 4-cylinder 1988-1989 1200 cc, 4-cylinder
Wheelbase	1980-1981 1200 cc, 4-cylinder 1982-1983 1200 cc, 4-cylinder 1984-1985 1200 cc, 4-cylinder 1986-1987 1200 cc, 4-cylinder 1988-1989 1200 cc, 4-cylinder
Front suspension	1980-1981 1200 cc, 4-cylinder 1982-1983 1200 cc, 4-cylinder 1984-1985 1200 cc, 4-cylinder 1986-1987 1200 cc, 4-cylinder 1988-1989 1200 cc, 4-cylinder
Rear suspension	1980-1981 1200 cc, 4-cylinder 1982-1983 1200 cc, 4-cylinder 1984-1985 1200 cc, 4-cylinder 1986-1987 1200 cc, 4-cylinder 1988-1989 1200 cc, 4-cylinder
Front fender	1980-1981 1200 cc, 4-cylinder 1982-1983 1200 cc, 4-cylinder 1984-1985 1200 cc, 4-cylinder 1986-1987 1200 cc, 4-cylinder 1988-1989 1200 cc, 4-cylinder
1988-1989	1980-1981 1200 cc, 4-cylinder 1982-1983 1200 cc, 4-cylinder 1984-1985 1200 cc, 4-cylinder 1986-1987 1200 cc, 4-cylinder 1988-1989 1200 cc, 4-cylinder
1992-93	1980-1981 1200 cc, 4-cylinder 1982-1983 1200 cc, 4-cylinder 1984-1985 1200 cc, 4-cylinder 1986-1987 1200 cc, 4-cylinder 1988-1989 1200 cc, 4-cylinder
Rear fender	1980-1981 1200 cc, 4-cylinder 1982-1983 1200 cc, 4-cylinder 1984-1985 1200 cc, 4-cylinder 1986-1987 1200 cc, 4-cylinder 1988-1989 1200 cc, 4-cylinder
1980-1981	1980-1981 1200 cc, 4-cylinder 1982-1983 1200 cc, 4-cylinder 1984-1985 1200 cc, 4-cylinder 1986-1987 1200 cc, 4-cylinder 1988-1989 1200 cc, 4-cylinder
1982-93	1980-1981 1200 cc, 4-cylinder 1982-1983 1200 cc, 4-cylinder 1984-1985 1200 cc, 4-cylinder 1986-1987 1200 cc, 4-cylinder 1988-1989 1200 cc, 4-cylinder

SUPPLEMENT

1980 AND LATER SERVICE INFORMATION

The following supplement provides procedures unique to the Honda GL1100 Standard and Interstate models for 1980-1983. All other service procedures are identical to 1979 models.

The chapter headings in this supplement correspond to those in the main body of this book. If a change is not included in the supplement, there are no changes affecting the 1980-1983 models.

CHAPTER ONE

GENERAL INFORMATION

Refer to Table 1 for general specifications.

Table 1 GENERAL SPECIFICATIONS (GL1100)

Engine type	4-stroke, SOHC, horizontally opposed 4 cylinder	
Bore and stroke	2.953×2.417 in (75×61.4 mm)	
Displacement	62.2 cu. in. (1,085 mm)	
Compression ratio	9.2 to 1	
Carburetion	4 Keihin carburetors with accelerator pump on No. 3 carburetor only	
Ignition	Capacitor discharge ignition (CDI)	
Lubrication	Wet-sump, filter, oil pump	
Clutch	Wet multi-disc	
Transmission	5-speed, constant mesh	
Transmission ratios	1980-1981	1982-on
1st	2.500	2.500
2nd	1.667	1.667
3rd	1.286	1.250
4th	1.065	1.000
5th	0.909	0.829
Final reduction ratio	3.091	3.100
Starting system	Electric starter only	
Battery	12 volt, 20 amp/hour	
Alternator	Three phase, AC, 300 watt/5,000 rpm	
Firing order	1-3-2-4	
Steering head angle	20° 30'	
Trail	5.3 in. (134 mm)	
Wheelbase	63.2 in. (1,605 mm)	
Front suspension	Telescopic fork 5.8 in. (147 mm) travel	
Rear suspension	Swing arm and shock absorbers 3.2 in. (80 mm) travel	
Front tire		
1980-1981	110/90-19 82H tubeless	
1982-on	120/90-18 65H tubeless	
Rear tire		
1980-1981	130/90-17 86H tubeless	
1982-on	140/90-16 71H tubeless	

(continued)

Table 1 GENERAL SPECIFICATIONS (GL1100) (continued)

Seat height	31.1 in. (795 mm)
Ground clearance	
1980-1982	5.7 in. (145 mm)
1982-on	5.5 in. (140 mm)
Overall height	
Standard	
1980-1982	47.0 in. (1,195 mm)
1982-on	46.9 in. (1,190 mm)
Interstate	
1980-1982	59.1 in. (1,500 mm)
1982-on	58.9 in. (1,495 mm)
Overall width (handlebar)	32.6 in. (820 mm)
Overall length	
Standard models	92.3 in. (2,345 mm)
Interstate	
1980-1982	94.7 in. (2,405 mm)
1983	96.9 in. (2,460 mm)
Dry weight	
Standard	
1980-1981	589 lb. (267 kg)
1982	595 lb. (270 kg)
1983	600 lb. (272 kg)
Interstate	
1980-1981	673 lb. (305 kg)
1982	679 lb. (308 kg)
1983	686 lb. (311 kg)
Curb weight	
Standard	
1980-1981	639 lb. (290 kg)
1982	646 lb. (293 kg)
1983	645 lb. (294 kg)
Interstate	
1980-1981	723 lb. (328 kg)
1982	729 lb. (331 kg)
1983	737 lb. (334 kg)
Fuel capacity	
Total	5.3 U.S. gal. (20 liters, 4.4 imp. gal.)
Reserve	1.1 U.S. gal. (4.0 liters, 0.9 imp. gal.)

CHAPTER TWO

TROUBLESHOOTING

CAPACITOR DISCHARGE IGNITION

1. *Engine cranks but will not start*—Make sure the engine stop switch is ON. Check that all 4 spark plug wires are attached to the correct cylinder's spark plug and are on tight. Inspect for fouled spark plugs, clean if necessary. Check ignition timing as described in the Chapter Three section in the supplement and adjust if necessary.

2. *No spark at plugs*—Make sure the engine stop switch is ON. Check the battery for a full charge. Test the ignition coil(s) and pulse generators as described in Chapter Seven section in the supplement. If there is no primary voltage to the ignition coils and points, check for loose or broken wire(s), defective switches (ignition, engine stop,

starter). The spark plugs may also be defective. If all these units test okay, the spark unit may be defective.

3. *Engine starts but runs only on 2 cylinders*—One of the pulse generators is not working correctly or is grounded. One of the ignition coils is not working properly or one set of spark plug wires is loose or disconnected.

4. *Engine starts but runs poorly*—The ignition timing may be incorrect or the ignition timing advance mechanism may not be working properly. Test all ignition parts as described in the supplement. Check the spark plugs for fouling or wear and replace if necessary. Make sure the spark plug wires are routed to the correct spark plugs.

CHAPTER THREE

PERIODIC MAINTENANCE AND LUBRICATION

ROUTINE CHECKS

Refer to **Table 2** for recommended lubricants, fluids and capacities for the GL1100.

Refer to **Table 3** for recommended tire inflation pressures.

PERIODIC MAINTENANCE

Clutch Adjustment (1982-on)

In order for the clutch to fully engage and disengage, there must be 3/8-3/4 in. (10-20 mm) free play at the lever end (**Figure 1**).

Follow the clutch adjustment procedure described under *Clutch Adjustment* in Chapter Three in the main body of this book.

Clutch Adjustment (1982)

NOTE

Clutch adjustment on 1982-on models is limited to adjustment of the cable only. There is no adjustment possible at the clutch lifter mechanism.

1. Loosen the locknut and screw the cable adjuster all the way into the clutch lever bracket.
2. Loosen the locknut and turn the cable lower adjuster clockwise as viewed from the top. This will loosen the clutch cable.
3. Rotate the lower clutch cable adjuster counterclockwise until there is about 5/8 in. free play at the lever end. Tighten the locknut.
4. Unscrew the cable adjuster to set the free play between 3/8-3/4 in. (10-20 mm). See Figure 1. Tighten the locknut.
5. Road test the bike to make sure that the clutch fully disengages when the lever is pulled in; if it does not, the bike will creep in gear when stopped. Also make sure the clutch fully engages; if it does not, the clutch will slip, particularly when accelerating in a high gear.

Brake Bleeding (1983)

This procedure is not necessary unless the brakes feel spongy, there has been a leak in the system, a component has been replaced or the brake fluid has been replaced. The front hand lever and master cylinder control the front left-hand caliper assembly. The rear brake pedal and master cylinder are hydraulically connected to and control the front right-hand caliper and the single rear caliper.

NOTE

When bleeding the unified brake system, first bleed the right-hand front caliper and then the rear caliper. Do not try to bleed both front caliper assemblies at the same time.

1. Remove the dust cap from the brake bleed valve (Figure 2).

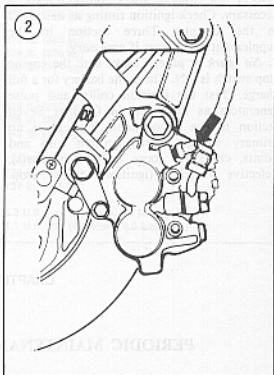
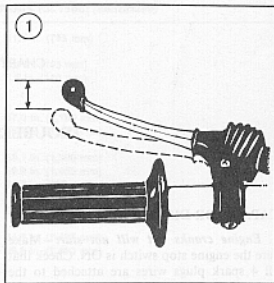

2. Connect a length of clear tubing to the bleed valve on the caliper. Place the other end of the tube into a clean container. Fill the container with enough fresh brake fluid to keep the end submerged. The tube should be long enough so that a loop can be made higher than the bleed valve to prevent air

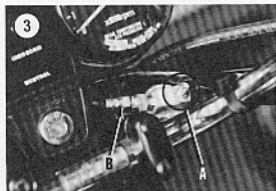

from being drawn into the caliper during bleeding.

CAUTION

Cover the fuel tank and instrument cluster with a heavy cloth or plastic tarp to protect it from accidental spilling of brake fluid. Wash brake fluid off of any painted or plated surface immediately, as it will destroy the finish. Use soapy water and rinse completely.

3. Clean the top of the master cylinder of all dirt and foreign matter. Remove the cap and diaphragm. Fill the reservoir almost to the top lip; insert the diaphragm and the cap loosely. Leave the cap in place during this procedure to prevent the entry of dirt.

WARNING

Use brake fluid clearly marked DOT 3 only. Others may vaporize and cause brake failure. Always use the same brand name; do not intermix as many brands are not compatible.

4. When bleeding the front system, insert a 15 mm (1/2 in.) spacer between the handlebar grip and the brake lever. This will prevent over-travel of the piston within the master cylinder. Slowly apply the brake lever (or pedal) several times. Hold the lever (or pedal) in the applied position. Open the bleed valve about one-half turn. Allow the lever (or pedal) to travel to its limit (against the installed spacer on the lever). When this limit is reached, tighten the bleed screw. As the fluid enters the system, the level will drop in the reservoir. Maintain the level at about 3/8 inch

from the top of the reservoir to prevent air from being drawn into the system.

5. Continue to pump the lever or pedal and fill the reservoir until the fluid emerging from the hose is completely free of bubbles.

NOTE

Do not allow the reservoir to empty during the bleeding operation or more air will enter the system. If this occurs, the entire procedure must be repeated.

6. Hold the lever or pedal in the applied position, tighten the bleed valve, remove the bleed tube and install the bleed valve dust cap.

7. If necessary, add fluid to correct the level in the reservoir. It should be to the upper level line.

8. Install the reservoir cap.

9. Test the feel of the brake lever and pedal. It should be firm and should offer the same resistance each time it's operated. If it feels spongy, it is likely that there still is air in the system and it must be bled again. When all air has been bled from the system and the fluid level is correct in the reservoir, double-check for leaks and tighten all the fittings and connections.

WARNING

Before riding the motorcycle, make certain that the brakes are operating correctly by operating the lever or pedal several times.

Front Fork Oil Change

1. Rest the bike on the centerstand.
2. Remove the air valve cap and bleed off all air pressure from each fork by depressing the valve stem (A, Figure 3).

WARNING

Always bleed off all air pressure; failure to do so may cause personal injury when disassembling the fork.

NOTE

Release the air pressure gradually. If released too fast, fork oil will spurt out with the air. Protect your eyes and clothing accordingly.

3. Disconnect the air hose first from the top fork cap/air valve assembly that is fitted with the air hose connector (B, **Figure 3**) and then from the other top fork cap/air valve (**Figure 4**).

NOTE

The air hose connector may have been installed on either the right- or left-hand fork leg upon assembly by the dealer or the last time it was serviced. It does not make any difference which side it is on.

4. Unscrew the air hose connector from the top fork cap/air valve assembly (**Figure 5**).
5. Place a drain pan under the drain screw of each fork leg and remove the drain screw (**Figure 6**) from each fork leg.
6. Apply the front brake and push down on the handlebars several times to pump the forks and expell any remaining fork oil. *Never* reuse the oil.

CAUTION

Do not allow the fork oil to come in contact with any of the brake components.

7. Inspect the condition of the gasket on the drain screw; replace it if necessary. Install both drain screws.
8. Place wood block(s) under the engine so the front wheel is off of the ground.
9. Unscrew the top fork cap/air valve assembly. Unscrew the fork cap slowly as it is under spring pressure from the fork spring. Withdraw the fork spring from the fork tube.
10. Refill each fork leg with DEXRON ATF (automatic transmission fluid) or fork oil. The quantity for each fork leg is as follows:
a. 1980-1981 models: 7.0 oz. (220 cc).
b. 1982-on models: 9.8 oz. (290 cc).

NOTE

In order to measure the correct amount of fluid, use a plastic baby bottle. These have measurements in fluid ounces (oz.) and cubic centimeters (cc) on the side.

11. Install the fork spring.
12. Inspect the condition of the O-ring seal on the fork cap bolt/air valve assembly; replace if necessary.

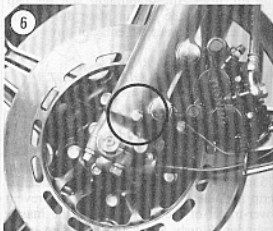

13. Install the fork top cap while pushing down on the spring. Start the fork cap bolt slowly; don't cross thread it. Tighten fork cap bolt/air valve assembly to 17 ft.-lb. (2.3 mkg).
14. Repeat Steps 9-12 for the other fork leg.
15. After the fork cap bolt/air valve assemblies are tightened they must be aligned

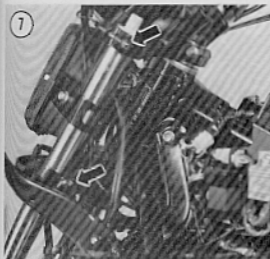

to their original position to correctly accept the air hose. If necessary loosen the upper and lower fork bridge bolts (Figure 7) and rotate the fork tube until alignment is correct. Retighten the upper fork bridge bolt to 16 ft.-lb. (2.2 mkg) and the lower to 25 ft.-lb. (3.5 mkg).

NOTE

On Interstate models it is necessary to remove the front fairing as described under Front Fairing Removal/Installation in the Chapter Twelve section of this supplement.

16. Apply a light coat of grease to the new O-ring seals (Figure 8) on the air hose connector and air hose.

17. Install the air hose connector and tighten to 4 ft.-lb. (0.6 mkg).

18. Install the air hose first to the top fork cap/air valve assembly and tighten to 4 ft.-lb. (0.6 mkg). Install the air hose to the air hose connector and tighten the fitting to 13 ft.-lb. (1.8 mkg).

NOTE

Hold onto the air hose connector (attached to the top fork cap/air valve assembly) with a wrench while tightening the air hose fitting.

19. Inflate the forks to 14-21 psi (1.0-1.5 kg/cm²). Do not use compressed air; only use a small hand-operated air pump as shown in Figure 9.

WARNING

Never use any type of compressed gas as an explosion may be lethal. Never heat the fork assembly with a torch or place it near an open flame or extreme heat as this will also result in an explosion.

20. Road test the bike and check for leaks.

Changing Final Drive Oil

1. Ride the bike until normal operating temperature is obtained. Usually 15-20 minutes of stop-and-go riding is sufficient.

2. Place the bike on the centerstand.

3. Place a drain pan under the drain plug.

4. Remove the oil fill cap (A, Figure 10) and the drain plug (B, Figure 10).

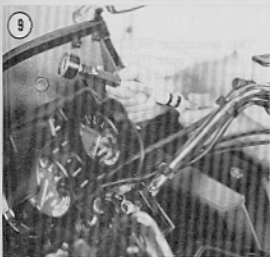

5. Let the oil drain for at least 15-20 minutes to assure that the majority of the oil has drained out.
6. Inspect the condition of the sealing washer on the drain plug; replace the sealing washer if necessary.
7. Install the drain plug and tighten it securely.
8. Insert a funnel into the oil fill cap hole and add approximately 4.7-5.4 oz. (140-160 cc) of hypoid gear oil. Remove the funnel and make sure the oil level comes up to the bottom of the oil fill cap bolt hole.

NOTE

Use SAE 90 for temperatures above 41° F (5° C) or SAE 80 for temperatures below 41° F (5° C).

NOTE

In order to measure the correct amount of fluid, use a plastic baby bottle. The have measurements in fluid ounces (oz.) and cubic centimeters (cc) on the side.

9. Install the oil fill cap.
10. Test ride the bike and check for oil leaks. After the test ride recheck the oil level; readjust if necessary.

ENGINE TUNE-UP

Refer to Table 4 for engine tune-up specifications.

Valve Clearance

The valve clearance procedure is the same as on previous years with the exception of the clearance dimension. The correct valve clearance is as follows:

- a. Intake valves: 0.004 in. (0.1 mm).
- b. Exhaust valves: 0.005 in. (0.13 mm).

Ignition Timing

The Honda GL1100 is equipped with a capacitor discharge ignition system (CDI). This system uses no breaker points and the timing cannot be adjusted. The timing can be checked with a strobe light to make sure that all components are working properly. If timing is incorrect, refer to the Chapter Seven section of this supplement.

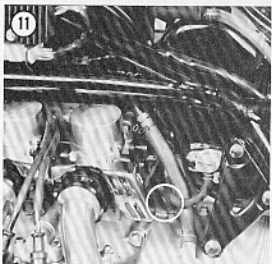
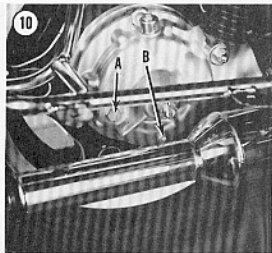

This procedure requires a special timing cap (Honda part No. HC 63068) for the timing hole; it is available from a Honda dealer. If not used, considerable oil mist will fling out of the hole onto the engine.

1. Start the engine and let it reach normal operating temperature, then shut it off.
2. Place the bike on the centerstand.
3. Remove the ignition timing mark cap (Figure 11) and install the special timing cap.
4. Connect a portable tachometer following the manufacturer's instructions. The bike's tachometer is not accurate enough in the low rpm range for this adjustment.

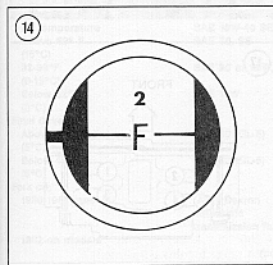
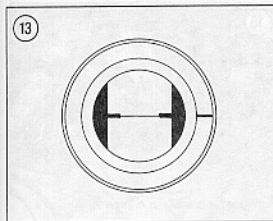
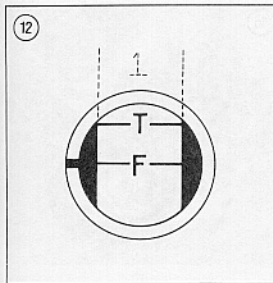

5. Connect a strobe timing light to the No. 2 cylinder spark plug lead (front cylinder left-hand side) following the manufacturer's instructions.

6. Start the engine and let it idle (950 ± 100 rpm); aim the timing light at the timing window and pull the trigger. If the timing mark (F-1) aligns with the fixed pointer (Figure 12) the timing is correct.

7. If the timing is incorrect, there is a problem with one of the ignition components. Refer to the Chapter Seven section of this supplement.

8. Also check the ignition advance alignment. Restart the engine and increase engine speed to slightly above 3,000 rpm; check alignment of the full advance marks and the fixed pointer (Figure 13). If the idle speed alignment is correct but the full advance is incorrect, refer to *Ignition Advance Mechanism* in the Chapter Seven section of this supplement.

CAUTION

Do not rev the engine past 8,000 rpm for a sustained period of time with no load on it. Possible engine damage may result.

9. Shut off the engine and reconnect the timing light to the No. 4 cylinder spark plug lead (rear cylinder, left-hand side).

10. Start the engine and let it idle (950 ± 100 rpm); aim the timing light at the timing window and pull the trigger. If the timing mark (F-2) aligns with the fixed pointer (Figure 14), the timing is correct.

11. If the timing is incorrect, there is a problem with one of the ignition components. Refer to the Chapter Seven section of this supplement.

12. Shut off the engine and disconnect the timing light and portable tachometer. Remove the special timing cap and install the timing hole cover.

Carburetor Synchronization

When the carburetors are properly synchronized the engine will warm up faster and there will be an improvement in throttle response, performance and mileage.

Prior to synchronizing the carburetors, the air cleaner must be clean and the valve clearance must be properly adjusted. The ignition timing must also be correct.

This procedure requires 2 special tools. You will need a mercury manometer (carb-sync tool). This is a tool that measures the manifold vacuum for all 4 cylinders simultaneously. A carb-sync tool (Figure 15) can be purchased from a Honda dealer, motorcycle supply store or mail order firm.

NOTE

When purchasing this tool check that it is equipped with restrictors. These restrictors keep the mercury from being drawn into the engine when engine rpm is increased during the adjustment procedure. If the mercury is drawn into the engine the tool will have to be replaced.

The other special tool needed is a carburetor adjusting wrench, also available from a Honda dealer. It is the carburetor adjusting wrench (part No. 07908-4220100).

1. Place the bike on the centerstand, start the engine and warm it up just until it will idle reliably. Do not allow it to reach full operating temperature as this may lead to overheating during the test procedure. Shut off the engine.

2. Remove the vacuum plug (consisting of a screw and flat washer) from each of the 4 intake ports (Figure 16).

3. Connect the vacuum lines from the carb-sync tool, following the manufacturer's instructions. Be sure to route the vacuum lines to the correct cylinder. Most carb-sync tools have the cylinder number indicated on them adjacent to each tube containing mercury.

NOTE

The No. 3 carburetor (rear cylinder, right-hand side) has no synchronization screw; the other 3 carburetors must be synchronized to it. The carburetors are numbered in the same manner as the cylinders (Figure 17).

4. Start the engine and let it idle at 950 rpm \pm 100 rpm.

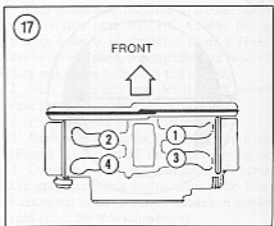
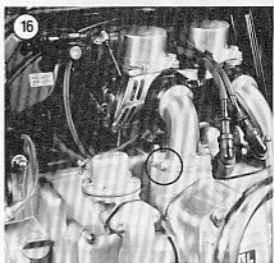
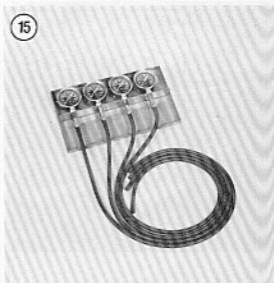

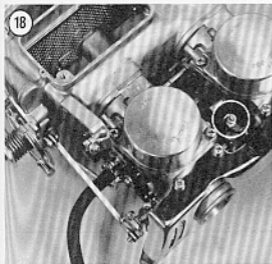

5. If the difference in gauge readings is 2.0 in. Hg (50 mm Hg) or less among all 4 cylinders the carburetors are considered synchronized. If not, proceed as follows.

6. Using the special tool described in the introduction to the procedure, loosen the locknut and turn the adjusting screw on the No. 1 carburetor (Figure 18). Turn the adjusting screw until the reading is the same as that on the No. 3 carburetor. Tighten the locknut. Open the throttle a little and close it back down after each adjustment.

CAUTION

If your carb-sync tool is not equipped with restrictors, open and close the throttle very gently to avoid sucking mercury into the engine. If this happens, it will not harm the engine but will render the tool useless.

NOTE

Figure 18 is shown with the carburetor assembly removed for clarity. Do not remove for this procedure.

7. Perform Step No. 6 for the No. 2 and 4 carburetors. Repeat Step 6 until all carburetors have the same gauge readings as the No. 3 carburetor.

NOTE

To gain the utmost in performance and efficiency from the engine, adjust the carburetors so that the gauge readings are as close to each other as possible.

8. After all carburetors are adjusted properly make sure all locknuts are tight.

9. Shut off the engine and remove the vacuum lines. Install the screws and washers into the vacuum ports (Figure 16). Make sure they are in tight to prevent a vacuum leak.

10. Restart the engine and readjust the idle speed if necessary; refer to *Carburetor Idle Adjustment* in Chapter Three in the main body of this book.

Table 2 RECOMMENDED LUBRICANTS, FLUIDS, AND CAPACITIES

	Type	Capacity
Engine oil		
All temperature	SAE 10W-40 SE	3.4 U.S. quarts;
Above 59° F (15°C)	SAE 30, SE	3.2 liters
32-59°F (0-15°C)	SAE 20 or 20W, SE	
Below 32°F (0°C)	SAE 10W	
Final drive oil		
Above 41°F (5°C)	SAE 90 (GL-5)	4.7-5.4 U.S. oz.; 140-160 cc
Below 41°F (5°C)	SAE 80 (GL-5)	
Fork oil:		
1980-1981 models	(ATF) Dexron automatic transmission fluid	7.0 U.S. oz.; 220 cc
1982-on models		9.8 U.S. oz.; 290 cc

(continued)

Table 2 RECOMMENDED LUBRICANTS, FLUIDS, AND CAPACITIES (continued)

	Type	Capacity
Drive shaft	Molybdenum disulfide grease (NGLI-2)	90 grams
Coolant	Ethylene glycol for aluminum engines	3.6 U.S. quarts; 3.4 liters
Fuel	86 (pump) octane 91 (research) octane	Total: 5.3 U.S. gallons; 4.4 imp. gallons; 2.0 liters ----- Reserve: 1.1 U.S. gallons; 0.9 imp. gallons; 4.0 liters

Table 3 TIRE PRESSURES

	Front psi (kg/cm ²)	Rear psi (kg/cm ²)
Under 200 lb. load	32 (2.25)	32 (2.3)
Over 200 lb. load	28 (2.0)	40 (2.8)

Table 4 ENGINE TUNE-UP SPECIFICATIONS

Valve clearance (cold)	
Intake	0.004 in. (0.10 mm)
Exhaust	0.005 in. (0.13 mm)
Spark plug type	
Standard heat range	
1980-1981	ND X24ES-U, NGK D8EA or Champion AB-Y
1982-on models	ND X24EPR-U9 or NGK DPR8EA-9
Cold climate	
1980	ND X27ES-U or NGK D9ES
1981	ND X27ESR-U or NGK D9ES
1982-on	ND X22EPR-U9 or NGK DPR7EA-9
Extended high speed riding:	
1980	ND X22ES-U or NGK D7ES
1981	ND X22ESR-U or NGK D7ES
1982-on	ND X27EPR-U9 or NGK DPR9EA-9
Gap:	
1980-1981	0.024-0.028 in. (0.6-0.7 mm)
1982-on	0.031-0.035 in. (0.8-0.9 mm)
Ignition timing	
Advance at idle:	
1981-1982	13° BTDC at 950 rpm
1982-on	10° BTDC at 950 rpm
Maximum advance	38.5° BTDC above 950 rpm
Idle speed	950 rpm
Firing order	1-3-2-4

CHAPTER FOUR

ENGINE

The engine in the GL1100 is basically the same as the one used in the GL1000 in prior years. The main difference is an increase in bore size from 2.83 in. (72.0 mm) to 2.953 in. (75.0 mm). This increases the displacement from 61.0 in. (999 cc) to 66.2 in. (1,085cc).

The stroke length and compression ratio are the same as on previous models. Refer to Table 5 for complete engine specifications.

ENGINE REMOVAL/INSTALLATION (1983)

Engine removal and installation is the same as on previous models with the exception of having to move the disc brake pressure control valve and holder bracket. If they are not moved they will be snagged by the vacuum controller during engine removal. The hydraulic brake lines do not have to be disconnected for this procedure.

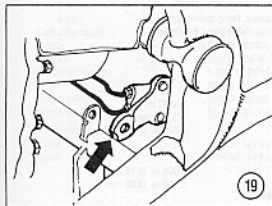

1. Remove the bolt securing the bracket that holds the metal and flexible brake lines to the frame on the left-hand side.
2. Push the pressure control valve and holder bracket back and position it onto the frame cross member as shown in Figure 19.
3. After the engine is installed, reposition the pressure control valve and holder bracket back to its original location.
4. Move the bracket at the rear into position on the frame. Install the bolt and tighten securely.

CYLINDER HEADS

Installation

Cylinder head removal and installation is the same as on previous models; the torque specifications for the cylinder head bolts have been changed.

Torque the bolts in the sequence shown in Figure 20. Tighten the six 10 mm bolts to 40 ft.-lb. (5.5 mkg) and the one 6 mm bolt to 8 ft.-lb. (1.0 mkg).

VALVES AND VALVE SEATS

The valves on the GL1100 must not be ground as they are manufactured with a special surface on the valve face. If the valve face is rough, worn unevenly or contacts the valve seat improperly, the valve must be replaced.

CRANKCASE

Assembling the Crankcase

Crankcase assembly is the same as on previous models; the torque specifications for the connecting rod cap nuts and the main bearing cap bolts have been changed.

Tighten the connecting rod bearing cap nuts to 23 ft.-lb. (3.2 mkg).

Tighten the bolts on the center main bearing cap to 51 ft.-lb. (7.0 mkg) and the 2

outer main bearing cap bolts to 36 ft.-lb. (5.0 mkg).

PISTONS AND
CONNECTING RODSConnecting Rod Bearing
and Crankpin Inspection

The torque specification for the connecting rod cap nuts has been changed. Tighten the connecting rod bearing cap nuts to 23 ft.-lb. (3.2 mkg).

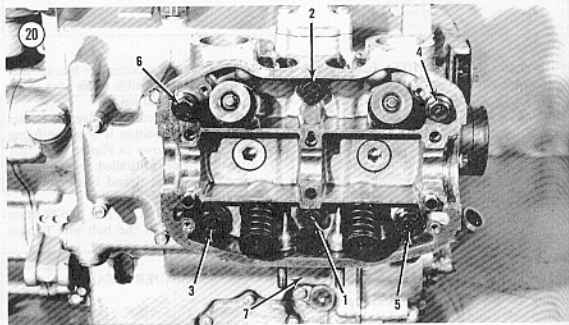

Table 5 ENGINE SPECIFICATIONS

Item	Specifications	Wear Limit
General		
Type	4-stroke, liquid cooled, sohc	
Engine layout	Horizontal opposed 4-cylinder	
Displacement	66.2 cu.in. (1,085 cc)	
Compression ratio	9.2 to 1	
Firing order	1-3-2-4	
Cylinders		
Bore	2.9528-2.9533 in. (75.000-75.015 mm)	2.9567 in. (75.100 mm)
Cylinder/piston clearance	0.0008-0.0026 in. (0.020-0.065 mm)	0.006 in. (0.15 mm)
Out of round	--	0.006 in. (0.15 mm)
Taper	--	0.002 in. (0.05 mm)

(continued)

Table 5 ENGINE SPECIFICATIONS (continued)

Item	Specifications	Wear limit
Pistons		
Diameter at skirt	2.9508-2.9520 in. (74.950-74.980 mm)	2.9468 in. (74.850 mm)
Clearance in bore	0.0008-0.0026 in. (0.020-0.055 mm)	0.006 in. (0.15 mm)
Ring groove width		
Top and second	0.0475-0.0480 in. (1.205-1.220 mm)	0.0512 in. (1.300 mm)
Oil ring	0.0986-0.0992 in. (2.505-2.520 mm)	0.1024 in. (2.600 mm)
Piston rings		
Number per piston		
Compression	2	
Oil control	1	
Ring end gap		
Top and second	0.004-0.012 in. (0.1-0.3 mm)	0.02 in. (0.6 mm)
Oil (side rail)	0.008-0.035 in. (0.2-0.9 mm)	0.04 in. (1.1 mm)
Ring side clearance		
Top and second	0.0006-0.0018 in. (0.015-0.045 mm)	0.004 in. (0.09 mm)
Crankshaft and connecting rods		
Runcut	—	0.0019 in. (0.050 mm)
Main bearing oil clearance	0.0008-0.0017 in. (0.020-0.044 mm)	0.0031 in. (0.080 mm)
Connecting rod oil clearance	0.0008-0.0017 in. (0.020-0.044 mm)	0.0031 in. (0.080 mm)
Connecting rod big end side clearance	0.006-0.012 in. (0.15-0.30 mm)	0.016 in. 0.41 mm
Crankpin and main journal out-of-round	—	0.0003 in. (0.008 mm)
Camshaft		
Valve timing at 1 mm lift		
Intake valve		
Opens	5° (BTDC)	
Closes	43° (ABDC)	
Exhaust valve		
Opens	45° (BBDC)	
Closes	5° (ATDC)	
Cam lobe height		
Intake	1.46 in. (37.0 mm)	1.45 in. (36.8 mm)
Exhaust	1.45 in. (36.8 mm)	1.44 in. (36.6 mm)
End journal diameter	1.061-1.062 in. (26.95-26.97 mm)	1.059 in. (26.91 mm)
Center journal diameter	0.9817-0.9823 in. (24.934-24.950 mm)	0.980 in. (24.91 mm)
Valve springs free length		
Outer	1.72 in. (43.8 mm)	1.67 in. (42.5 mm)
Inner	1.58 in. (40.2 mm)	1.54 in. (39.0 mm)

(continued)

Table 5 ENGINE SPECIFICATIONS (continued)

Item	Specifications	Wear Limit
Valves		
Intake stem OD	0.259-0.260 in. (6.58-6.59 mm)	--
Exhaust stem OD	0.2579-0.2583 in. (6.55-6.56 mm)	--
Intake head diameter	1.496 in. (38.00 mm)	--
Exhaust head diameter	1.260 in. (32.00 mm)	--
Seat width	0.06 in. (1.4 mm)	
Valve guide ID		
Intake and exhaust	0.260-0.261 in. (6.60-6.62 mm)	0.2614 in. (6.64 mm)
Valve stem-to-guide clearance		
Intake	0.0004-0.0016 in. 0.010-0.040 mm	0.003 in. (0.07 mm)
Exhaust	0.002-0.003 in. (0.05-0.07 mm)	0.004 in. (0.10 mm)

CHAPTER FIVE

CLUTCH AND TRANSMISSION

CLUTCH

Removal

NOTE

The first 3 steps apply only if the engine is in the frame.

1. Remove the rear wheel as described in the Chapter Ten section of this supplement.
2. Remove the exhaust system as described in the Chapter Six section of this supplement.
3. Remove the clutch cable cover and disconnect the clutch cable at the engine.
4. Remove the Phillips head screws securing the clutch cover and lift the cover off (Figure 21).

NOTE

On models since 1982, don't lose the clutch lifter piece within the clutch cover.

5. Remove the clutch lifter rod from the clutch lifter.
6. Remove the bolts securing the clutch lifter and remove the clutch lifter (Figure 22).

NOTE

Note that the 2 longer dowel bolts are installed in the clutch lifter holes marked with raised buttons. They must be reinstalled into the same holes during assembly.

7. Remove the clutch springs.
8. Remove the clutch locknut and lockwasher (Figure 23).

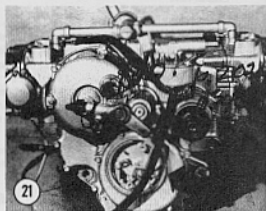

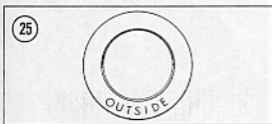
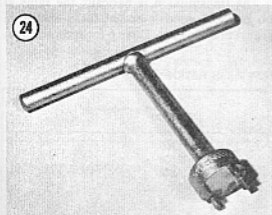
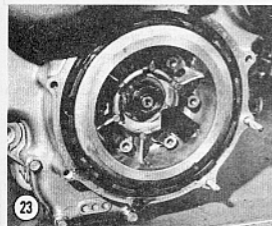
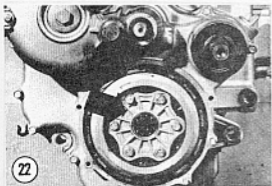
**NOTE**

Clutch nut removal requires a special tool available from a Honda dealer (Locknut Wrench Socket—part No. 07716-0020202). See Figure 24.

- Withdraw the clutch center, friction discs, clutch plates, pressure plate and clutch housing as an assembly.

NOTE

The clutch housing cannot be removed without first removing the engine from the frame and removing the engine rear cover.

- Remove the splined spacer from the transmission main shaft.

Disassembly/Assembly

Refer to Chapter Five in the main body of this book.

Installation

- Install the splined spacer on the transmission main shaft.
- Install the clutch center, friction discs, clutch plates and pressure plate as an assembly.
- Install the lockwasher with the dished side facing toward the outside. The word "OUTSIDE" stamped on it must face outward (Figure 25).
- Install the locknut and tighten with the special tool shown in Figure 24. Tighten the locknut to 44 ft.-lb. (6.0 mkg).
- Install the clutch springs onto the bosses on the clutch center.

NOTE

The clutch lifter plate is held in place with 6 bolts. Two of these bolts are of a special type called dowel bolts. They have a long shoulder and are longer in overall length than the other 4.

- The clutch lifter plate has 2 holes marked with raised buttons (these are for the dowel bolts). See Figure 26. Align these 2 holes with the 2 holes in the pressure plate that have recessed threads to accept the long shoulder of the dowel bolts (Figure 27). Install the clutch lifter.

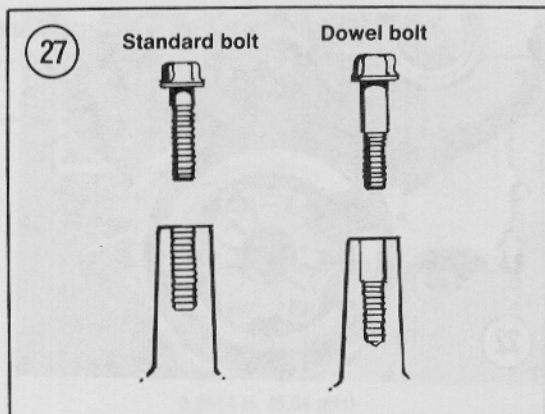
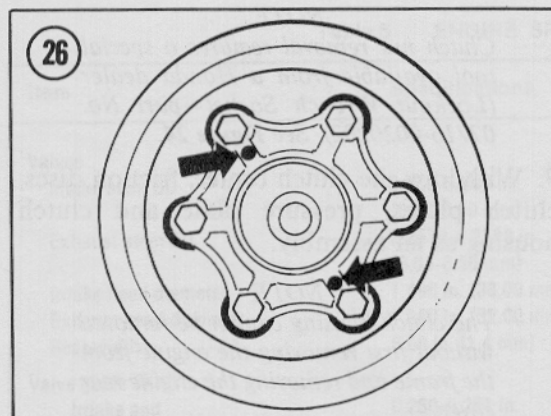

7. Install the longer 2 dowel bolts into the holes in the lifter plate marked with the raised buttons (Figure 26).

8. Install the 4 shorter bolts into the other 4 holes and finger-tighten all bolts. If one of the dowel bolts will not screw all the way in *stop immediately* as it may be installed in the wrong hole. Remove all bolts and repeat Step 6 making sure the alignment is correct between the 2 clutch parts.

9. Tighten the 6 bolts in a crisscross pattern to 7 ft.-lb. (1.0 mkg).

10. Install the clutch lifter.

NOTE

On 1982-on models, make sure the lifter piece is in position on the clutch

lifter within the clutch cover prior to installation.

11. Install the clutch cover.

12. Connect the clutch cable and the clutch cable cover.

13A. On 1980-1981 models, adjust the clutch as described under *Clutch Adjustment* in Chapter Three in the main body of this book.

13B. On 1982-on models, adjust the clutch as described under *Clutch Adjustment* in the Chapter Three section of this supplement.

TRANSMISSION

The transmission is basically the same as on previous models except for a change of gear ratios. Refer to **Table 6** for specifications.

Table 6 TRANSMISSION GEAR RATIOS

Gear	Ratio	
	1980-1981	1982-on
Primary drive	1.708	1.708
First	2.500	2.500
Second	1.667	1.667
Third	1.286	1.250
Fourth	1.065	1.000
Fifth	0.909	0.829

CHAPTER SIX

FUEL AND EXHAUST SYSTEMS

CARBURETOR

Removal

NOTE

The carburetors are numbered in the same sequence as the engine cylinders. The No. 1 carburetor is located on the front right-hand side with the No. 3 directly behind it. The No. 2 is located on the front left-hand side with the No. 4 directly behind it (Figure 28). Remember that the right- and left-hand sides refer to the carburetor assembly as it sits in the bike's frame, not as it sits on your workbench.

1. Place the bike on the centerstand and remove the seat and top compartment cover.
2. Remove the wing nut securing the air cleaner cover and remove the air cleaner cover (Figure 29).
3. Remove the air cleaner element.
4. Remove the bolts (Figure 30) securing the air cleaner case holder and remove the case holder.
5. Disconnect the breather hose (Figure 31) from each side of the air cleaner case and remove the air cleaner case.
6. Disconnect the spark plug caps (A, Figure 32) from the spark plugs and unhook the

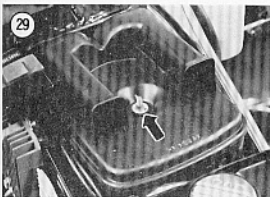
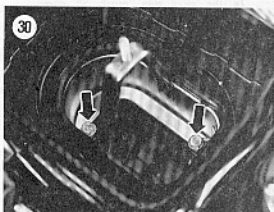
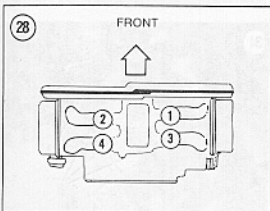

leads from the clips on the carburetor assembly (B, Figure 32).

7. Disconnect the fuel pump outlet line (C, Figure 32) from the fuel pump. Insert a golf tee into the fuel line to prevent fuel from draining out.

8. At the hand throttle, loosen the throttle cable locknut and turn the adjusting barrel all the way in. This provides the necessary slack for ease of cable removal at the carburetor assembly.

9. Loosen the clamping screw (A, Figure 33) on the choke cable and disconnect the cable from the carburetor assembly (B, Figure 33).

10. Disconnect the vacuum hose from the No. 3 carburetor (rear, right-hand carburetor).

11. Loosen the screws on the clamping bands (A, Figure 34) on all 4 carburetors.

12. Remove the bolts (B, Figure 34) securing the intake tubes to the cylinder heads and remove all 4 intake tubes and O-ring seals on the bottom of the intake tubes.

NOTE

In the next step, mark all parts removed with either a "No. 1" or "No. 3" so they will be reinstalled onto the correct carburetor.

13. Remove the screws securing the top covers on the No. 1 and No. 3 carburetors (both carburetors on the right-hand side). Remove both top covers, springs and vacuum piston assemblies. Place a clean shop rag into the carburetor throats to prevent the entry of foreign matter.

14. Partially pull the carburetor assembly to the left-hand side (Figure 35).

15. Loosen the locknut on both throttle cables (Figure 36) and remove the cables from the throttle wheel assembly. Tie the loose ends of the cables up out of the way onto the frame.

16. Carefully pull the carburetor assembly the rest of the way out of the frame. Watch that the lower portion of the assembly does not catch on the coolant tubes on top of the engine.

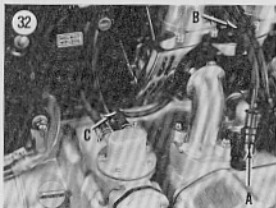

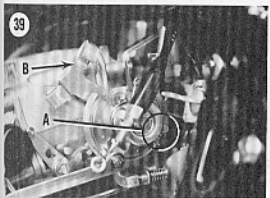
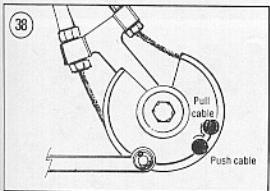

Installation

1. Install the carburetor assembly partially into position from the left-hand side of the frame.
2. Be sure the throttle cables and choke cable are in the correct position in the frame and that they are not twisted or kinked and do not have any sharp bends.
3. Attach the throttle "pull" cable onto the right-hand side of the throttle wheel (Figure 37) and into the upper hole in the throttle wheel (Figure 38).
4. Attach the throttle "push" cable onto the left-hand side of the throttle wheel (A, Figure 39) and into the lower hole in the throttle wheel (Figure 38).
5. Move the carburetor assembly farther toward the right and position both throttle cables into the bracket (B, Figure 39). Tighten the locknuts finger-tight at this time.
6. Move the carburetor assembly all the way into position and tighten the locknuts securely.
7. Install the vacuum piston assemblies, springs and carburetor top caps to the No. 1 and No. 3 carburetors.
8. Install the intake tubes onto the carburetor throats. Push the intake tube all the way in until the notch in the tube is nestled up against the raised button on the carburetor. They must be pushed in all the way for correct alignment with the cylinder heads. Do not tighten the clamping bands at this time.
9. Make sure there is an O-ring seal in place in the groove in the bottom of each intake tube. Align the carburetor assembly and install the bolts securing the intake tubes to the cylinder heads. Start all bolts by hand prior to tightening any of the bolts.
10. Tighten all intake tube bolts securely in a crisscross pattern.
11. Tighten the clamping band screws securely.
12. Connect the vacuum hose to the No. 3 carburetor (rear, right-hand carburetor).
13. Connect the choke cable to the carburetor assembly and tighten the clamping screw (A, Figure 33).
14. Connect the fuel pump outlet line (C, Figure 32) to the fuel pump.

15. Connect the spark plug caps (A, Figure 32) to the spark plugs and hook the lead into the clips on the carburetor assembly.
16. Make sure the gasket (Figure 40) between the carburetor air chamber and the air cleaner case is in position.
17. Install the air cleaner case and connect the breather hose (Figure 31) to each side of the air cleaner case.
18. Install the air cleaner holder and install the bolts.
19. Install the air cleaner element and install the air cleaner cover. Tighten the wing nut securely.
20. Install the top compartment cover and seat.
21. Adjust the throttle cable as described under *Throttle Operation* in Chapter Three in the main body of this book.

Disassembly/Cleaning/Inspection

It is recommended that only one carburetor be disassembled and cleaned at one time. This will prevent intermixing of parts. The No. 3 carburetor is equipped with an accelerator pump.

NOTE

All 4 carburetors look the same, but slight differences exist among all of them. Take note of this prior to disassembly.

All components that require cleaning can be removed from the carburetor body without removing the carburetors from the air chamber.

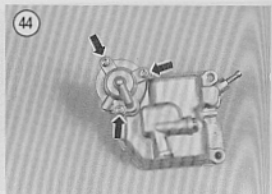
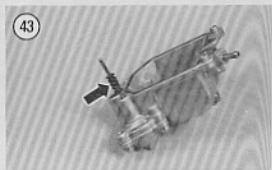
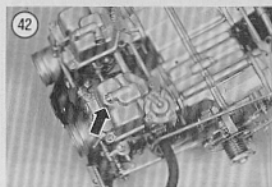
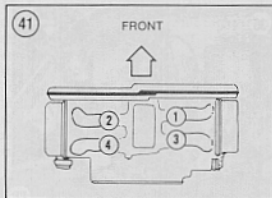

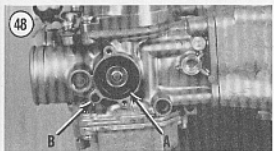
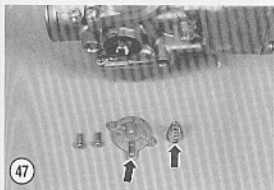
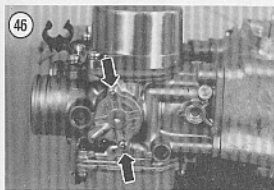
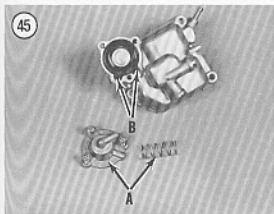

NOTE

The carburetors are numbered in the same sequence as the engine cylinders. The No. 1 carburetor is located on the front right-hand side with the No. 3 directly behind it. The No. 2 is located on the front left-hand side with the No. 4 directly behind it (Figure 41). Remember that the right- and left-hand sides refer to the carburetor assembly as it sits in the bike's frame, not as it sits on your workbench.

1. On the No. 3 carburetor only, disassemble the accelerator pump assembly. Remove the screws securing the float bowl and remove the float bowl (Figure 42). Remove the small rubber boot on the accelerator pump shaft (Figure 43). Remove the screws (Figure 44) securing the accelerator pump cover. Remove the cover and spring (A, Figure 45) and withdraw the diaphragm and shaft assembly.
2. On carburetors so equipped, disassemble the air cutoff valve. Remove the screws (Figure 46) securing the air cutoff valve cover. Remove the cover and spring (Figure 47). Remove the diaphragm (A, Figure 48) and small O-ring seal (B, Figure 48).
3. Remove the screws (Figure 49) securing the carburetor top cover to the main body and remove the cover.
4. Remove the compression spring (A, Figure 50) and vacuum cylinder assembly (B, Figure 50).
5. Remove the O-ring seal and the air jet cover (Figure 51).
6. Disassemble the vacuum cylinder assembly (Figure 52).

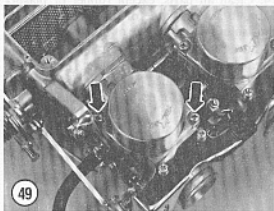

7. Remove the screws (Figure 42) securing the float bowl to the main body and remove it.

NOTE

The float bowl is removed from the No. 3 carburetor during accelerator pump removal.

8. Remove the gasket from the float bowl (Figure 53).

9. Carefully push out the float pivot pin (Figure 54).

10. Lift the float and needle valve (Figure 55) out of the main body.

11. Remove the main jet and the needle jet holder (Figure 56). Tilt the carburetor to the side and catch the needle jet as it slides out of the tube.

NOTE

Prior to removing the pilot screw, record the number of turns necessary until the screw lightly seats. Record the number of turns for all 4 carburetors as they must be reinstalled into the exact same setting.

12. Remove the pilot screw (A, Figure 57), spring, plain washer and O-ring.

13. If damage is evident remove the float valve seat and strainer (B, Figure 57).

NOTE

Further disassembly is neither necessary nor recommended. If throttle or choke shafts or butterflies are damaged, take the body to your dealer for replacement.

14. Clean all parts, except rubber or plastic parts, in a good grade of carburetor cleaner. This solution is available at most automotive or motorcycle supply stores in a small, resealable tank with a dip basket (Figure 58). If it is tightly sealed when not in use, the solution will last for several cleanings. Follow the manufacturer's instructions for correct soak time (usually about 1/2 hour).

NOTE

It is recommended that one carburetor be cleaned at a time to avoid interchanging of parts.

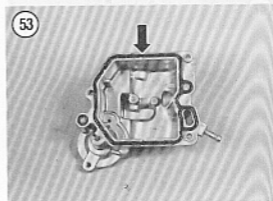
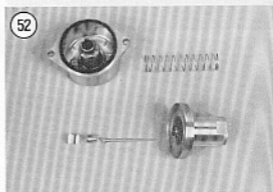
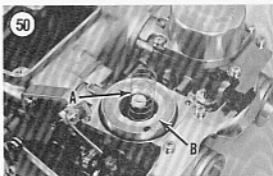

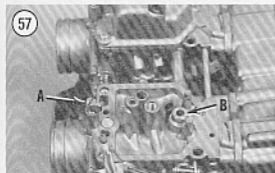
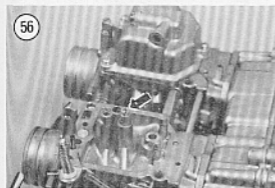
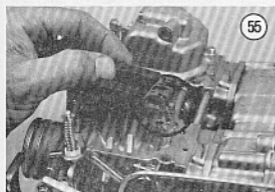
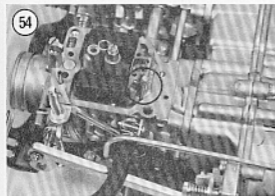

15. Remove the parts from the cleaner and blow dry with compressed air. Blow out the jets with compressed air. *Do not* use a piece of wire to clean them as minor gouges in a jet can alter flow rate and upset the fuel/air mixture.

16. Inspect the end of the float valve needle (Figure 59) and seat for wear or damage; replace either or both parts if necessary.

17. Repeat Steps 1-16 for the other 3 carburetors; note that Steps 1 and 2 are performed only on specific carburetors, as indicated.

18. Replace any O-rings and gaskets that appear to be damaged or deteriorated. O-ring seals tend to become hardened after prolonged use and heat and therefore lose their ability to seal properly. Replace as necessary.

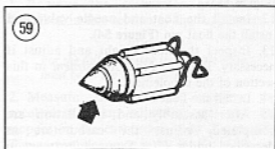
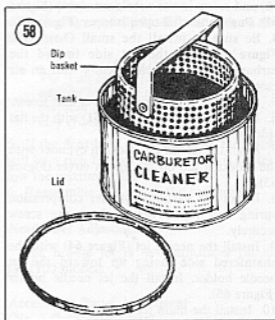

Assembly

1. Screw the pilot screw into the exact same position (same number of turns) as recorded in *Removal Step 12*.

NOTE

If a new pilot screw was installed turn it 1 1/4 turns out from the lightly seated position.

2. When installing the diaphragm on the accelerator pump make sure the 2 tabs on the diaphragm align with the notches in the float bowl (B, Figure 45). Inspect the diaphragm for cracks and hardening; ensure that the rod is not bent. Be sure to install the rubber boot (Figure 43) onto the diaphragm rod.

3. Assemble the vacuum cylinder. Insert the jet needle into the vacuum cylinder (Figure 60) and screw in the needle set screw (Figure 61). Push in the full open stopper (Figure 62).

4. Be sure to install the small O-ring (B, Figure 48) with the flat side toward the carburetor body, on carburetors with an air cutoff valve.

5. Install the gasket, air jet cover and screw.

6. Install the seal ring (Figure 51) with the flat side on first.

7. Align the slot in the vacuum cylinder with the indexing tab on the air jet cover (Figure 63).

8. Install the vacuum cylinder compression spring and top cover. Tighten the screw securely.

9. Install the needle jet (Figure 64) with the chamfered side facing up toward the jet needle holder. Install the jet needle holder (Figure 65).

10. Install the main jet (Figure 56).

11. Install the needle valve onto the float (Figure 55).

12. Install the float and needle valve and install the float pin (Figure 54).

13. Inspect the float height and adjust if necessary. Refer to *Float Adjustment* in this section of the supplement.

14. Install the float bowl.

15. After assembly and installation are completed, adjust the carburetors as described under *Pilot Screw Adjustment* in

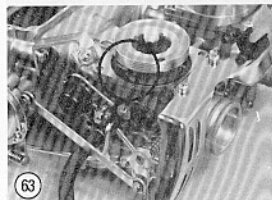
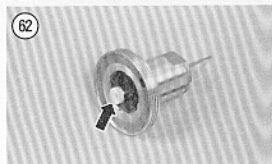

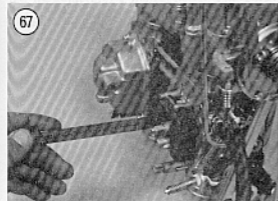
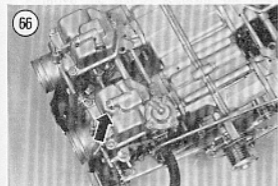
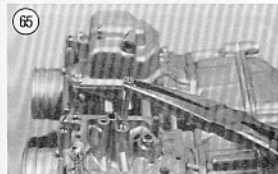

this section of the supplement and *Carburetor Synchronization* in the Chapter Three section of the supplement.

CARBURETOR ADJUSTMENTS

Float Adjustment

The carburetor assembly has to be removed and partially disassembled for this adjustment.

1. Remove the carburetors as described in this section of the supplement.
2. Remove the screws securing the float bowls (Figure 66) to the main bodies and remove them.
3. Hold the carburetor assembly so that the float arm is just touching the float needle. Use a float level gauge or small ruler and measure the distance from the carburetor body to the float arm (Figure 67). The correct height is 0.61 in. (15.5 mm).
4. Adjust by carefully bending the tang on the float arm.

CAUTION

The floats on all 4 carburetors must be adjusted to exactly the same height to maintain the same fuel/air mixture to all 4 cylinders.

5. If the float level is set too high, the result will be a rich fuel/air mixture. If it is set too low the mixture will be too lean.
6. Reassemble and install the carburetor.

Needle Jet Adjustment

The needle jet is *non-adjustable* on all GL1100 models.

Accelerator Pump Adjustment (No. 3 Carburetor Only)

1. Remove the carburetor assembly as described in this section of the supplement.

NOTE

For the following step the throttle valve must be in the closed position.

2. Measure the distance between the accelerator pump adjusting arm and the stopper on the carburetor body (Figure 68). The correct clearance is 0.4 in. (10 mm).

3. If adjustment is necessary, carefully bend the adjusting arm and repeat Step 2 until correct clearance is obtained.

Choke Adjustment

1. Operate the choke knob and check for smooth operation of the cable and choke mechanism.
2. Pull the knob all the way *up* to the closed position.
3. At the carburetor assembly, move the choke lever (A, Figure 69) to make sure it is at the end of its travel thus closing the choke valves. If you can move the choke lever an additional amount it must be adjusted as described in Step 4.
4. To adjust, loosen the cable clamping screw (B, Figure 69) and move the cable sheath *up* until the choke lever is fully closed. Hold the choke lever in this position and tighten the cable clamping screw securely.
5. Push the choke knob all the way *down* to the fully open position.
6. At the carburetor assembly, check that the choke lever is fully open by checking for free play between the cable and the choke lever. The cable should move slightly as there should be no tension on it.
7. If proper adjustment cannot be achieved using this procedure the cable has stretched and must be replaced. Refer to *Choke Cable Replacement* in this chapter of the supplement.
8. The choke knob should remain in whatever position it is placed from fully closed to fully open. If it does not, pull up on the rubber cover and turn the adjuster. Look down onto the knob and turn it either clockwise to increase resistance or counterclockwise to decrease resistance.

Pilot Screw Adjustment (And New Limiter Cap Installation—U.S. Only)

To comply with U.S. emission control standards, a limiter cap is attached to each pilot screw. This is to prevent the owner from readjusting the factory setting. The limiter cap will allow a maximum of 7/8 of a turn of

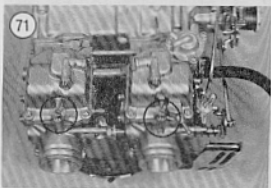
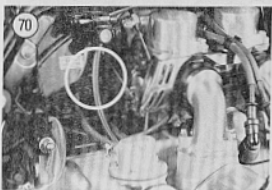
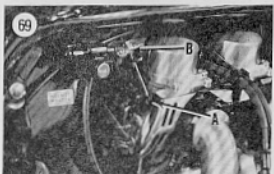

the pilot screw to a leaner mixture only. The pilot screw is preset at the factory and should not be reset unless the carburetor has been overhauled.

CAUTION

Do not try to remove the limiter cap from the pilot screw; it is bonded in place and will break off and damage the pilot screw if removal is attempted.

NOTE

Perform Steps 1, 2 and 3 only if new pilot screws have been installed or the carburetors have been overhauled. Do not install the new limiter caps onto the pilot screws until this procedure is completed.

The air cleaner must be cleaned before starting this procedure or the results will be inaccurate.

1. Remove the carburetor assembly as described in this section of the supplement.
2. Remove the screws securing the float bowls and remove the float bowls.
3. For the preliminary adjustment, carefully turn the pilot screw on each carburetor in until it *lightly seats* and then back it out 1 1/4 turns. Remember, do not install the limiter caps at this time.
4. Install the float bowls and install the carburetor assembly.
5. Start the engine and let it reach normal operating temperature. Stop-and-go riding for approximately 10 minutes is sufficient.
6. Connect a portable tachometer following the manufacturer's instructions. The bike's tachometer is not accurate enough at a low rpm.
7. Start the engine and turn the idle adjust screw (Figure 70) in or out to achieve the idle speed of 950 ± 100 rpm.
8. Turn each pilot screw out 1/2 turn from the initial setting of Step 1.
9. If engine speed *does* increase by 50 rpm or more, turn each pilot screw 1/2 turn out. When the engine speed does not change by 50 rpm or more, discontinue the 1/2 turn out increments at the No. 4 carburetor.

NOTE

All 4 carburetor pilot screws should now be turned out the exact same number of turns.

10. Turn the idle adjust screw in or out again to achieve the described idle speed of 950 ± 100 rpm.
11. Turn the pilot screw on the No. 1 carburetor in until engine speed drops by 50 rpm.
12. Turn the pilot screw on the No. 1 carburetor out one full turn from the position in Step 11.
13. Turn the idle adjust screw in or out again to achieve the desired idle speed of 950 ± 100 rpm.
14. Perform Steps 11, 12 and 13 on the No. 2, 3 and 4 carburetors.

WARNING

With the engine idling, move the handlebar from side to side. If idle speed increases during this movement, the throttle cables need adjustment or they may be incorrectly routed through the frame. Correct this problem immediately. Do not ride the bike in this unsafe condition.

15. Turn the engine off and disconnect the portable tachometer.
16. After this adjustment is completed, test ride the bike. Throttle response from idle should be rapid and without any hesitation.

NOTE

Perform the following step only if new limiter caps are to be installed.

17. Apply Loctite No. 601, or equivalent, to the limiter cap and install it on the pilot screw. Position the limiter cap against the stop on the float bowl (Figure 71) so that the pilot screw can only turn *clockwise*, not counterclockwise.

NOTE

Figure 71 is shown with the carburetor assembly removed for clarity. Do not remove it for this procedure.

Rejetting The Carburetors

Do not try to solve a poor running engine problem by rejetting the carburetors if all of the following conditions hold true.

1. The engine has held a good tune in the past with the standard jetting.
2. The engine has not been modified.
3. The motorcycle is being operated in the same geographical region under the same general climatic conditions as in the past.
4. The motorcycle was and is being ridden at average highway speeds.

If those conditions all hold true, the chances are that the problem is due to a malfunction in the carburetor or in another component that needs to be adjusted or repaired. Changing carburetion jet size probably won't solve the problem. Rejetting the carburetors may be necessary if any of the following conditions hold true.

1. A non-standard type of air filter element is being used.
2. A non-standard exhaust system is installed on the motorcycle.
3. Any of the top end components in the engine (pistons, cam, valves, compression ratio, etc.) have been modified.
4. The motorcycle is in use at considerably higher or lower altitudes or in a considerably hotter or colder climate than in the past.
5. The motorcycle is being operated at considerably higher speeds than before and changing to colder spark plugs does not solve the problem.
6. Someone has previously changed the carburetor jetting.
7. The motorcycle has never held a satisfactory engine tune.

If it is necessary to rejet the carburetors, check with a dealer or motorcycle performance tuner for recommendations as to the size of jets to install for your specific situation.

If you do change the jets do so only one size at a time. After rejetting, test ride the bike and perform a spark plug test; refer to *Reading Spark Plugs* in Chapter Three of the main body of the book.

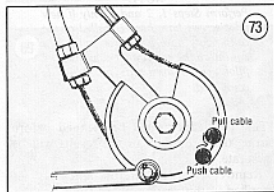
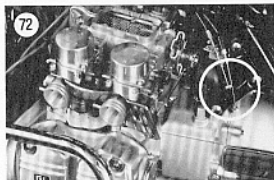

Throttle Cable Replacement

1. Remove the seat and the top compartment cover.
2. On Interstate models, remove the front fairing as described in the Chapter Twelve section of this supplement.
3. Disconnect the front brake light switch electrical connectors.
4. Remove the screws securing the upper and lower right-hand switch/throttle housing together.
5. Slide the housing from the handlebar and disengage the throttle cables from the throttle grip.

6. Remove the carburetor assembly as described in this section of the supplement.

NOTE

It may not look like it, but it is practically impossible to remove the throttle cables from the carburetors with the carburetor assembly in place. There is not enough room for 2 hands within the area.

NOTE

The piece of string attached in the next step will be used to pull the new throttle cables back through the frame so they will be routed in the exact same position.

7. Tie a piece of heavy string or cord (approximately 6-8 ft./1.8-2.4 m long) to the carburetor end of the throttle cables (Figure 72). Wrap this end with masking or duct tape. Do not use an excessive amount of tape as it will be pulled through the frame loop during removal. Tie the other end of the string to the frame.

8. At the throttle grip end of the cables, carefully pull the cables (and attached string) out through the frame, past the electrical harness and components and from behind the steering head area. Make sure the attached string follows the same path of the cables through the frame.

9. Remove the tape and untie the string from the old cables.

10. Tie the string to the new throttle cables and wrap it with tape.

11. Carefully pull the string back through the frame routing the new cables through the same path as the old cables.

12. Remove the tape and untie the string from the cables and the frame.

CAUTION

The throttle cables are the push/pull type and must be installed as described and shown in Steps 13 and 14. Do not intermix the 2 cables.

13. Attach the throttle "pull" cable to the top portion of the throttle wheel (Figure 73). The other end is attached to the front receptacle of the throttle/switch housing.

14. Attach the throttle "push" cable to the lower portion of the throttle wheel (Figure 73). The other end is attached to the rear receptacle of the throttle/switch housing.

15. Install the throttle/switch housing. Make sure the pin on the lower portion of the switch housing is indexed into the hole in the handlebar. Tighten the screws securely. Attach the front brake light switch connectors.

16. Operate the throttle grip and make sure the carburetor throttle linkage is operating correctly and with no binding. If operation is incorrect or there is binding carefully check that the cables are attached correctly and there are no tight bends in the cables.

17. Install the carburetor assembly, top compartment cover and the seat.

18. Adjust the throttle cables as described under *Throttle Operation* in Chapter Three in the main body of the book.

19. Test ride the bike slowly at first and make sure the throttle is operating correctly.

Choke Cable Replacement

1. Remove the seat and the top compartment cover.

2. On Interstate models, remove the front fairing as described in the Chapter Twelve section of this supplement.

3. Loosen the choke cable clamp screw (B, Figure 69) and remove the cable end from the choke linkage (A, Figure 69).

NOTE

The piece of string attached in the next step will be used to pull the new choke cable back through the frame so it will be routed in the same position as the old cable.

4. Tie a piece of heavy string or cord (approximately 6-8 ft./1.8-2.4 m long) to the carburetor end of the choke cable. Wrap this end with masking or duct tape. Do not use an excessive amount of tape as it will be pulled through the frame loop during removal. Tie the other end of the string to the frame.

5. Completely unscrew the locknut (Figure 74) securing the choke knob assembly to the bracket.

6. At the choke knob end of the cable, carefully pull the cable (and attached string) out through the frame and from behind the steering head area. Make sure the attached string follows the same path that the cable does through the frame.
7. Remove the tape and untie the string from the old cable.

NOTE

Make sure the locknut is positioned on the string so it will be located below the mounting bracket when the cable is installed.

8. Tie the string to the new choke cable and wrap it with tape.
9. Carefully pull the string back through the frame routing the new cable through the same path as the old cable.
10. Remove the tape and untie the string from the cable and the frame.
11. Screw the locknut onto the choke cable knob assembly and tighten securely.
12. Attach the choke cable to the carburetor choke linkage as shown in **Figure 69**.
13. Operate the choke knob and make sure the carburetor choke linkage is operating correctly and with no binding. If operation is incorrect or there is binding carefully check that the cable is attached correctly and there are no tight bends in the cable.
14. Adjust the choke cable as described under *Choke Adjustment* in this section of the supplement.
15. Install the top compartment cover and the seat.

FUEL TANK**Sealing (Pin-hole Size)**

A pin-hole size leak can be sealed with the use of a product called Theroxite Gas Tank Sealer Stick or equivalent. Follow the manufacturer's instructions.

Sealing (Small Hole Size)

This procedure requires the use of a non-petroleum, non-flammable solvent.

If you feel unqualified to accomplish it, take the tank to a dealer and have them seal the tank for you.

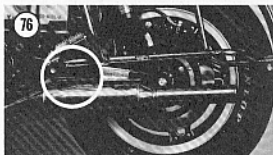
**WARNING**

Before attempting any service on the fuel tank be sure to have a fire extinguisher rated for gasoline or chemical fires within reach. Do not smoke or allow anyone to smoke or work where there are any open flames (i.e. water heater or clothes drier gas pilot). The work area must be well-ventilated.

1. Remove the fuel tank as described under *Fuel Tank Removal/Installation* in Chapter Six in the main body of this book.
2. Mark the spot on the tank where the leak is visible with a grease pencil.
3. Remove the fuel sender unit from the tank as described under *Fuel Sender Replacement* in Chapter Six in the main body of this book. Plug the tank opening with a piece of non-porous material and seal with duct tape. Thoroughly clean the surrounding area with ignition contact cleaner so the tape will stick securely.
4. Remove the fuel filler cap and turn the fuel shutoff valve to the RES position. Use compressed air and direct the air nozzle into the fuel filler neck; blow the interior of the tank dry.

5. Turn the fuel shutoff valve to the OFF position and pour about 1 quart (1 liter) of non-petroleum solvent into the tank; install the fuel filler cap and shake the tank vigorously 1 or 2 minutes. This is to remove all fuel residue.
6. Drain the non-petroleum based solution into a safe storable container. This solution may be reused. Let the tank air out overnight before using the sealant.
7. Remove the fuel shutoff valve from the tank. If necessary, plug the tank opening with a cork and/or tape it closed with duct tape. Thoroughly clean the surrounding area with ignition contact cleaner so the tape will stick securely.
8. Again blow the tank interior completely dry with compressed air.
9. The following step is best done out of doors as the fumes are very strong and flammable. Pour a sealant into the tank (a silicone rubber base sealer like Pro-Tech or Kreem Super Sealer or equivalent). These are available at most motorcycle supply stores.

CAUTION

Do not spill the sealant onto the painted surface of the tank as it will destroy the painted finish.

10. Position the tank so that the point of the leak is at the lowest part of the tank. This will allow the sealant to accumulate at the point of the leak.
11. Let the tank sit in this position for at least 48 hours.
12. After the sealant has dried, remove the sealing plugs and install the fuel sender unit and the fuel shutoff valve. Turn the fuel shutoff valve to the OFF position and refill the tank with fuel.
13. After the tank has been filled, let it sit for at least 2 hours and recheck the leak area.

14. Install the fuel tank, top compartment cover and the seat.

EXHAUST SYSTEM

The exhaust system consists of an integral exhaust pipe and muffler unit on each side of the bike. They are interconnected with a crossover pipe under the engine.

Removal/Installation

1. Place the bike on the centerstand.

NOTE

Remove all attachment nuts from one side at a time.

2. Remove the nuts and lockwashers (Figure 75) securing the exhaust pipe flanges to the cylinder head.
3. Loosen the bolts and nuts clamping the crossover pipe together.
4. Remove the nuts (Figure 76) securing the rear bracket and muffler to the frame.
5. Remove the exhaust system on one side by pulling the exhaust pipe/muffler assembly to the side to unhook the crossover pipe connection.
6. Repeat Steps 2-5 for the other side.
7. Inspect the condition of the gaskets at all joints; replace as necessary.
8. Be sure to install a new gasket in each exhaust port in the cylinder head.
9. Install one of the assemblies into position and install the rear mounting nuts only finger-tight until the exhaust flange nuts and washers are installed and securely tightened. This will minimize an exhaust leak at the cylinder head. Tighten all nuts securely.
10. Repeat for the other side and tighten the bolt and nut securing the crossover pipe securely.
11. After installation is complete, make sure there are no exhaust leaks.

CHAPTER SEVEN

ELECTRICAL SYSTEMS

Full-color wiring diagrams are at the end of the book.

VOLTAGE REGULATOR/ RECTIFIER

Removal/Installation

1. Remove both side covers and the seat.
2. Disconnect the battery negative lead.
3. Disconnect the 8-pin electrical connector (A, Figure 77) containing 8 wires (3 yellow, 1 black, 2 green and 2 red/white).
4. Remove the bolts securing the voltage regulator/rectifier in place (B, Figure 77).
5. Install by reversing these removal steps. Make sure all electrical connections are tight.

Rectifier Testing

To test the rectifier portion of the voltage regulator/rectifier, disconnect the 8-pin electrical connector from the harness (A, Figure 77).

Make the following measurements using an ohmmeter.

1. Connect the negative (-) ohmmeter lead to the green rectifier lead. Connect the positive (+) ohmmeter lead to each of the yellow leads in turn. These 3 measurements must be the same, all very high resistance (over 6,000 ohms).
2. Connect the positive (+) ohmmeter lead to the red/white rectifier lead. Connect the negative (-) ohmmeter lead to each of the yellow leads in turn. These 3 measurements must be the same, all very high resistance (over 6,000 ohms).
3. Reverse the ohmmeter leads and repeat Steps 1 and 2. This time, the readings must still be all the same, but just the opposite from the original measurements in Steps 1 and 2. That is, all original readings in Steps 1

and 2 were to be high (6,000 ohms); all readings must now be low (5-40 ohms).

4. If the voltage regulator/rectifier fails to pass any of these tests the unit is defective and must be replaced.

Voltage Regulator Performance Test

Connect a voltmeter to the battery negative and positive terminals (Figure 78). Leave the battery cables attached. Start the engine and let it idle; increase engine speed to about 3,000 rpm until the voltage applied to the battery reaches 14.0-15.0 volts. At this point, the voltage regulator/rectifier should prevent any further increase in voltage. If this does not happen and voltage increases above specifications, the voltage regulator/rectifier is faulty and must be replaced.

IGNITION SYSTEM

The ignition system consists of 2 ignition coils, 2 spark units, an ignition pulse generator and 4 spark plugs. Refer to Figure 79 for a diagram of the ignition circuit.

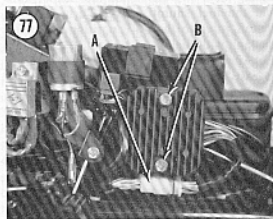

CAPACITOR DISCHARGE IGNITION

All GL1100's are equipped with a solid-state capacitor discharge ignition (CDI) system that uses no breaker points. This system provides a longer life for components and delivers a more efficient spark throughout the entire speed range of the engine. Ignition timing is non-adjustable.

Alternating current from the alternator is rectified to direct current and is used to charge the capacitor. As the piston approaches the firing position, a pulse from the pulse generator coil is used to trigger the silicone controlled rectifier. The rectifier in turn allows the capacitor to discharge quickly into the primary circuit of the ignition coil, where the voltage is stepped up in the secondary circuit to a value sufficient to fire the spark plugs of the No. 1 and No. 2 cylinders. The same sequence happens to the No. 3 and No. 4 cylinders. The distribution of the pulses from the pulse generator is

controlled by the rotation of the driven rotor in the ignition pulse generator.

NOTE

The spark plugs will fire at the same time (the No. 1 and 2 and the No. 3 and 4) but only one of the cylinders will be at TDC on the compression stroke. The other cylinder is on the exhaust stroke and the spark in that cylinder has no effect on it.

CDI Precautions

Certain measures must be taken to protect the capacitor discharge system. Instantaneous damage to the semiconductors in the system will occur if the following precautions are not observed.

1. Never connect the battery backwards. If the connected battery polarity is wrong, damage will occur to the voltage regulator/rectifier, the alternator and the spark unit.
2. Do not disconnect the battery when the engine is running. A voltage surge will occur which will damage the voltage regulator/rectifier and possibly burn out the lights.
3. Keep all connections between the various units clean and tight. Be sure that the wiring connections are pushed together firmly to help keep out moisture.
4. Do not substitute another type of ignition coil.
5. Each component is mounted within a rubber vibration isolator. Always be sure that the isolator is in place when installing any units of the system.

CDI Troubleshooting

Problems with the capacitor discharge system are usually the production of a weak spark or no spark at all.

1. Check all connections to make sure they are tight and free of corrosion.
2. Check the ignition coils as described under *Ignition Coil Testing* in this section of the supplement.
3. Check the pickup coils in the ignition pulse generator with an ohmmeter. Remove the left-hand side cover and disconnect the ignition pulse generator electrical connector

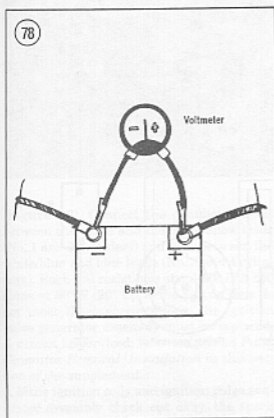

79

IGNITION CIRCUIT (1980-1981)

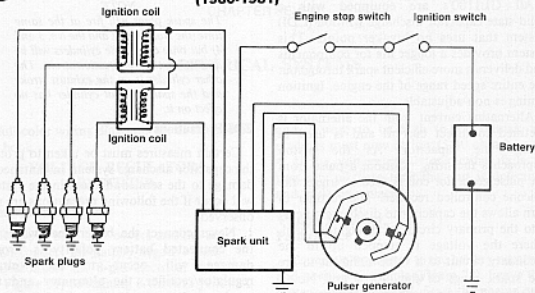

IGNITION CIRCUIT (1982-ON)

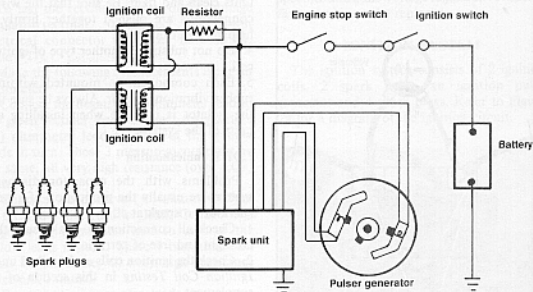

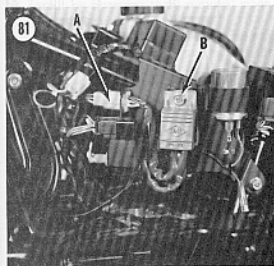
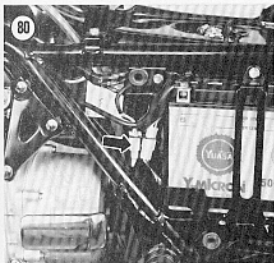

(Figure 80). Connect the ohmmeter leads between the white and the blue/yellow leads (No. 1 and 2 cylinders) and then between the white/blue and blue leads (No. 3 and 4 cylinders). Each coil resistance should be 530 ± 50 ohms at 68°F (20°C). If the pickup coils do not meet these specifications, the ignition pulse generator assembly must be replaced. It cannot be serviced; refer to *Ignition Pulse Generator Removal/Installation* in this section of the supplement.

4. If the ignition coils and ignition pulse generator assembly check out okay, the spark unit is at fault and must be replaced.

Spark Unit Replacement

1. Remove the seat and the top compartment cover.
2. Disconnect the battery negative lead.
3. Disconnect the electrical connectors going to the spark unit (A, Figure 81).
4. Remove the spark unit from the frame (B, Figure 81).
5. Install by reversing these removal steps. Make sure all electrical connections are tight and free of corrosion.

Spark Unit Testing

Tests may be performed on the unit but a good one may be damaged by someone unfamiliar with the test equipment. To be safe, have the test made by a dealer or substitute a known good unit for a suspected one.

IGNITION COIL

There are 2 ignition coils; the one on the left-hand side fires the No. 3 and 4 cylinders and the one on the right-hand side fires the No. 1 and 2 cylinders.

Removal/Installation

1. Remove the seat and the top compartment cover.
2. Disconnect the battery negative lead.
3. Disconnect the spark plug leads from the spark plugs.
4. Disconnect the primary wire connectors for both coils (blue and black/white—left-hand coil; yellow and black/white—right-hand coil).
5. Remove the bolts securing the ignition coils to the frame and remove both coils.
6. Install by reversing these removal steps, noting the following.
7. Make sure all electrical connections are tight and free of corrosion.
8. Route the spark plug wires to the correct cylinder (Figure 82).

Testing

The ignition coil is a form of transformer which develops the high voltage required to jump the spark plug gap. The only

maintenance required is that of keeping the electrical connections clean and tight and occasionally checking to see that the coils are mounted securely.

As a quick check of coil condition, disconnect the high voltage lead from the spark plug. Remove the spark plug from the cylinder head. Connect a new or known good spark plug to the high voltage lead and place the spark plug base on a good ground like the engine cylinder head. Position the spark plug so you can see the electrode.

WARNING

If it is necessary to hold the high voltage lead, do so with an insulated pair of pliers. The high voltage generated could produce serious or fatal shocks.

Push the starter button to turn the engine over a couple of times. If a fat blue spark occurs, the coil is in good condition; if not it must be replaced. Make sure that you are using a known good spark plug for this test. If the spark plug used is defective the test results will be incorrect.

Reinstall the spark plug in the cylinder head.

PULSE GENERATOR

Removal/Installation

1. Place the bike on the centerstand.
2. Remove the left-hand side cover and disconnect the battery negative lead.
3. Disconnect the pulse generator electrical connector (red colored connector) containing 4 wires (1 blue, 1 white/blue, 1 blue/yellow and 1 white). Refer to Figure 80.
4. Remove the rear wheel as described in the Chapter Ten section of the supplement.
5. Remove the rear swing arm as described in the Chapter Ten section of the supplement.
6. Remove the screws securing the pulse generator cover and remove the cover and gasket.
7. Disconnect the vacuum advance vacuum tube from the assembly.
8. Remove the screws (Figure 83) securing the pulse generator assembly.
9. Carefully pull the electrical harness, along with the rubber grommet, out from the engine

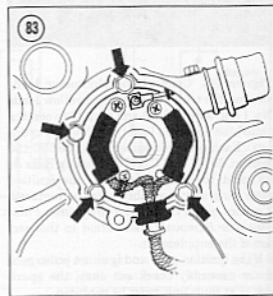
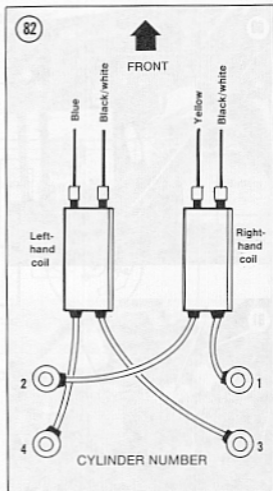

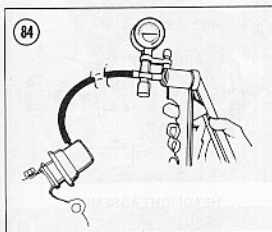

rear cover. Remove the pulse generator/vacuum advance unit assembly.

10. Install by reversing these removal steps, noting the following.

11. Route the electrical harness the same way it was. Make sure to keep it away from the exhaust system.

12. Attach the vacuum advance tube to the assembly.

13. Adjustment of the ignition timing is not necessary as the pulse generator can be installed only in one position.

IGNITION ADVANCE MECHANISM

The ignition advance mechanism advances the ignition (fires the spark plugs sooner) as engine speed increases. The GL1100 has both mechanical and vacuum advance mechanisms. If either of these mechanisms does not advance properly and smoothly, the ignition will be incorrect.

Mechanical Advance Removal/Installation

1. Remove the pulse generator as described in this section of the supplement.
2. With the mechanical advance unit still in place on the pulser shaft, rotate it back and forth and check for freedom of movement. If the movement sticks and does not move freely, remove and inspect the unit.

NOTE

If the ignition advance unit is separated assembly by aligning the raised tooth on the rotor with the cutout notch on the backing plate.

3. When installing the ignition advance unit, index the pin on the pulser shaft with the notch on the backside of the ignition advance unit.
4. Install the pulse generator assembly as described in this section of the supplement.

Mechanical Advance Inspection

1. Inspect the condition of the pivot points of each centrifugal weight. It must pivot freely to maintain proper ignition advance. Apply lightweight grease to the pivot pins and all sliding surfaces.
2. Inspect the pivot cam operation on the shaft. It must operate freely.
3. Make sure the centrifugal advance weight return springs completely retract the weights. If not, replace the ignition advance unit.

Vacuum Advance Inspection

1. Place the bike on the centerstand.
2. Remove the left-hand side cover and disconnect the battery negative lead.
3. Remove the rear wheel as described in the Chapter Ten section of the supplement.
4. Remove the swing arm as described in the Chapter Ten section of the supplement.
5. Remove the screws securing the pulse generator cover and remove the cover and gasket.
6. Disconnect the vacuum advance vacuum tube from the unit and attach a hand-operated vacuum pump (Figure 84) to the unit.
7. Apply vacuum to the unit and visually check that the vacuum advance is moving the base plate of the ignition pulser. The base plate should move when vacuum is applied as follows:
 - a. 1980 models—start moving at 1.6 in. Hg (40 mm Hg); stop moving at 3.9 in. Hg (100 mm Hg).
 - b. 1981-on models—start moving at 1.6 in. Hg (40 mm Hg); stop moving at 3.2 in. Hg (80 mm Hg).

8. If the vacuum advance unit does not operate properly the assembly must be replaced as described under *Ignition Pulse Generator Removal/Installation* in this section of the supplement.

9. Attach the vacuum tube to the engine and install the ignition pulse cover and gasket.

10. Install the swing arm and rear wheel.

11. Connect the battery negative lead and install the left-hand side cover.

LIGHTING SYSTEM

Standard Model

Headlight Replacement

(U.S., Canada and U.K.)

All models are equipped with a quartz halogen headlight. Special handling of the bulb is required as specified in this procedure.

Refer to **Figure 85** for this procedure.

1. Remove the mounting screws on each side securing the headlight assembly.
2. Pull out on the bottom of the headlight assembly and disengage it from the locating tab on top of the headlight housing.
3. Disconnect the electrical connector from the headlight lens unit.
4. Remove the bulb cover.
5. Remove the set spring and bulb assembly. Replace with a new bulb assembly—do not touch the bulb with your fingers.

CAUTION

Carefully read all instructions shipped with the replacement bulb. Do not touch the bulb glass with your fingers because of oil on your skin. Any traces of oil on the quartz halogen bulb will drastically reduce the life of the bulb. Clean any traces of oil from the bulb with a cloth moistened in alcohol or lacquer thinner.

6. Install by reversing these removal steps.
7. Adjust the headlight as described under *Headlight Adjustment* in Chapter Seven in the main body of this book.

City (Pilot) Lamp Replacement (U.K.)

The U.K. models of the GL1100 use the same headlight assembly as those for U.S.

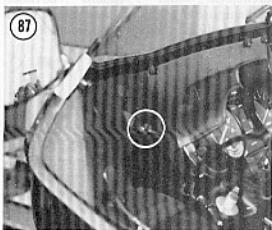
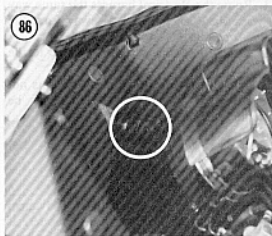
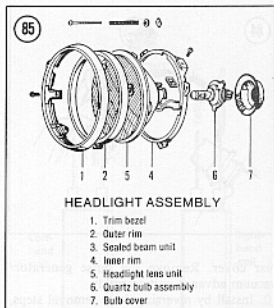



and Canada with the addition of the city (pilot) lamp.

Pull the city lamp out of the housing. Insert new bulb and push it back into the housing.

CAUTION

The city (pilot) lamp is also quartz. Carefully read all instructions shipped with the replacement bulb. Do not touch the bulb glass with your fingers because of oil on your skin. Any traces of oil on the quartz halogen bulb will drastically reduce the life of the bulb. Clean any traces of oil from the bulb

with a cloth moistened in alcohol or lacquer thinner.

Interstate Model Headlight Replacement (U.S., Canada and U.K.)

All models are equipped with a quartz halogen headlight. Special handling of the bulb is required as specified in this procedure.

1. Remove the small set screw in the adjusting knob (Figure 86).
2. Unscrew the nut, lockwasher and flat washer (Figure 87) on the post of the mounting bracket. Carefully tap on the end of this post to help push the headlight assembly forward and out of the fairing.
3. From the front of the fairing pull the headlight assembly out the rest of the way.
4. Disconnect the electrical connector (A, Figure 88) from the headlight lens unit.
5. Remove the bulb cover (B, Figure 88).
6. Remove the set spring and bulb assembly (Figure 89). Replace with a new bulb assembly—do not touch the bulb with your fingers.

CAUTION

Carefully read all instructions shipped with the replacement bulb. Do not touch the bulb glass with your fingers because of oil on your skin. Any traces of oil on the quartz halogen bulb will drastically reduce the life of the bulb. Clean any traces of oil from the bulb with a cloth moistened in alcohol or lacquer thinner.

7. Install by reversing these removal steps. Do not overtighten the set screw on the adjusting knob as the threads are very fine and are easily stripped.
8. Adjust the headlight as described under *Headlight Adjustment (Interstate Models)* in this section of the supplement.

Headlight Adjustment (Interstate Models)

Adjust the headlight horizontally and vertically according to Department of Motor Vehicle regulations in your area.

To adjust the headlight horizontally, turn the screw (Figure 90) on the right-hand side of

the headlight trim bezel. Tightening the screw turns the light toward the right-hand side of the rider and loosening the screw directs the light to the left-hand side of the rider.

To adjust the headlight vertically, turn the adjusting knob (Figure 86) inside the fairing. Turn it in the direction indicated on the knob.

Front Directional Signal Light Replacement (Interstate Models)

Remove the screws (Figure 91) securing the lens and remove the lens. Wash out the inside and outside of the lens with a mild detergent and wipe dry.

Inspect the condition of the lens gasket and replace if it is damaged or deteriorated.

Replace the bulb (Figure 92) and install the lens; do not overtighten the screws as the lens may crack.

Self-cancelling Turn Signal System (1982-on)

Models since 1982 are equipped with an electrical system that automatically cancels the turn signals. The system responds to the speed of the bike and the steering head angle.

The system consists of 4 units—the turn signal switch (with integral solenoid), the speed sensor located within the speedometer, the angle sensor located next to the steering head and the control unit (under the top storage compartment). The control unit deciphers information from both the speed sensor and the steering head angle sensor and signals the solenoid in the turn signal switch.

The turn signals will automatically be cancelled when the bike attains a predetermined rate of speed and when the steering head angle is less than 1.8° from the straight ahead position. The information, or signals, from both the speed sensor and the angle sensor are required before the control unit will energize the solenoid in the turn signal switch. When energized, the solenoid will move the turn signal switch to the OFF position.

At the time of publication there is no available factory service information for any of these components. If the system is not performing correctly, check that all electrical

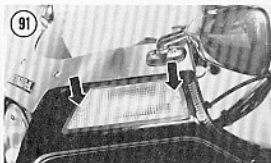

connections are tight and free of corrosion and make sure that there are no broken electrical wires. If everything checks out okay then have tests performed by a Honda dealer or substitute a known good unit for one suspected of being bad.

NOTE

The latter way of troubleshooting can be expensive as most dealers will not usually take back electrical components for a refund or exchange.

REAR SUSPENSION WARNING SYSTEM (AIR ASSIST SHOCK ABSORBER, 1982)

NOTE

1983 models are not equipped with this warning system because the rear shock recommended air pressure starts at zero.

The rear air assist shock absorbers have a warning system to notify the rider if the air pressure drops below the factory specified minimum of 28 psi (2.0 kg/cm²) when the bike is traveling in excess of 10 mph (15

kmph). This warning system consists of an air sensor that measures the air pressure within the shock absorber system. This sensor is attached to the 3-way connector where the air inlet valve and the rubber air hoses from each shock absorber are attached. Two electronic units decipher the air pressure information sent from the air sensor. One is the control unit which is located under the right-hand side cover and the other is the air indicator sensor located within the speedometer. Information sent from these 2 units goes to the air pressure warning light, located within the face of the tachometer; if air pressure is low the warning light will come on.

Figure 93 is an electrical schematic of the warning system.

In the event that the warning lamp comes on, reduce speed immediately to below 50 mph. Reinflate the rear shocks at a service station or with a portable hand pump. If the warning lamp is still on after the correct air pressure is reached the problem must be corrected as soon as possible. Proceed with the following tests to find the problem.

WARNING

Do not ride the bike with low air pressure in the rear shocks as it will result in unsafe handling and loss of stability.

Preliminary Test

- Place the bike on the sidestand and remove the seat and side covers.
- Turn the ignition switch to the OFF position.
- Turn the ignition switch to the ON position:
 - If the lamp remains off, proceed to *Test No. 1*.
 - If the lamp lights but goes off within 3 seconds, replace the control unit.
 - If the lamp lights but goes off within 3 to 7 seconds, but comes on after the bike has attained a speed of 13 mph (19 km/h) or more, proceed to *Test No. 2*.
 - If the lamp lights and remains on, proceed to *Test No. 3*.

Test No. 1

- Disconnect the electrical connector to the control unit. Connect an electrical wire jumper cable from the battery ground terminal to the black/white terminal of the control unit electrical connector.
- If the lamp comes on, proceed to Step 3. If the lamp fails to come on one of the following could be the problem:
 - Defective warning lamp (replace lamp).
 - Blown fuse (replace blown fuse).
 - Loose or damaged electrical connector or corroded terminals (tighten or clean all electrical connections).
 - Open circuit in the wiring harness between the control unit connector and the warning lamp or between the fuse and the warning lamp (replace the wiring harness or individual electrical wire).
- If the lamp came on in Step 2, use an ohmmeter and check for continuity between the control unit connector green terminal and the battery negative terminal. If there is continuity, proceed to Step 4. If there is no continuity one of the following could be the problem:
 - Loose or damaged electrical connector or corroded terminals (tighten or clean all electrical connections).
 - Open circuit in the wiring harness between the control unit's green terminal and the battery negative lead (replace the wiring harness or individual electrical wire).
- If there is continuity as measured in Step 3, reconnect the electrical connector to the control unit. Connect a DC voltmeter between the connector green terminal and the black/brown terminal. If the voltage is over 8 volts the control unit is faulty and must be replaced. If the voltage is below 8 volts one of the following could be the problem:
 - Loose or damaged electrical connector or corroded terminals (tighten or clean all electrical connections).
 - Open circuit in the wiring harness between the control unit's black/brown terminal and the fuse (replace the wiring harness or individual electrical wire).

93

**REAR SUSPENSION
LOW AIR PRESSURE
WARNING SYSTEM (1982)**

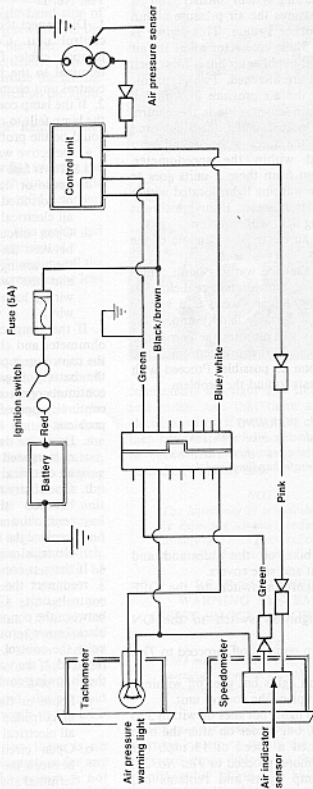

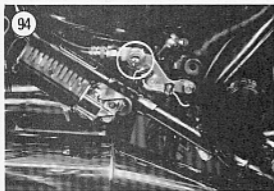

Test No. 2

1. Place the bike on the centerstand *for this test only*.

2. Remove the right-hand side panel and check the air pressure in the rear shocks at the air valve (Figure 94). If the air pressure is within specifications (28-64 psi/2.0-4.5 kg/cm²), proceed to Step 2. If the air pressure is low (below 28 psi/2.0 kg/cm²), inspect all air hose connections and hoses for leaks with soapy water. If any leaks are found either tighten the fittings or replace the O-ring seals at each connection. Replace the air hoses if there are leaks within the hoses other than at the fittings. The shock absorber may also be faulty and need replacing. If replacement of the air hoses or the shock absorber is necessary, refer to *Rear Shock Absorbers—Removal* in the Chapter Nine section of this supplement.

3. If the air pressure measured in Step 1 is within the specified range (28-64 psi/2.0-4.5 kg/cm²), disconnect the electrical wire at the air pressure sensor. Connect an ohmmeter between the outer housing of the air pressure sensor and the electrical connector coming from the sensor.

- Decrease the air pressure to below 28 psi (2.0 kg/cm²). There should be no continuity. If there is continuity the air pressure sensor is faulty and must be replaced.
- Increase the air pressure to above 45 psi (3.2 kg/cm²). There should be continuity. If there is no continuity the air pressure sensor is faulty and must be replaced.

c. If both step A and step B check okay, proceed to Step 4.

4. Disconnect the electrical connector from the control unit. Use an ohmmeter and check for continuity between the connector light blue terminal and the air sensor terminal (leave the light blue electrical wire connected to the air pressure sensor). If there is continuity between the light blue electrical terminal and the air sensor terminal continue to Step 5. If there is no continuity one of the following could be the problem:

- Loose or damaged electrical connector or corroded terminals (tighten or clean all electrical connections).
 - Open circuit in the wiring harness between the control unit's light blue terminal and the air pressure sensor.
5. Remove the speedometer housing and disassemble the cluster enough to gain access to the pink electrical wire at the air indicator sensor in the speedometer housing. Reconnect the electrical connector from the instrument cluster to the main wiring harness; also connect the separate pink connector. At the speedometer housing, disconnect the pink electrical wire at the back of the speedometer. At the air pressure sensor disconnect the light blue electrical wire going to the air pressure sensor. Ground this light blue wire to a frame ground with a short jumper wire. Disconnect the ground jumper wire and record the time required for the indicator lamp to come on after the ground wire is disconnected:
- If the warning light comes on within 4 seconds the control unit is faulty (replace the control unit).
 - If the warning light comes on after 4-8 seconds the air pressure sensor is faulty (replace the air pressure sensor).

NOTE

The warning lamp is located within the face of the tachometer but the air indicator sensor is located within the speedometer housing.

Test No. 3

- Place the bike onto the sidestand.
- Connect an electrical jumper cable between the pink and green terminals of the

electrical connector that is attached to the control unit. Leave the electrical connector attached to the control unit.

3. If the lamp goes out within 8 seconds, proceed to Step 4. If the lamp remains on disconnect the electrical connector from the control unit:

- If the warning light goes off the control unit is faulty (replace the control unit).
- If the warning light stays on there is an open circuit in the electrical harness between the warning lamp and the black/white terminal (replace the wiring harness or individual electrical wire).

4. If the lamp went out within 8 seconds in Step 3, remove the speedometer housing and disassemble the cluster enough to gain access to the electrical wires at the air indicator sensor within the speedometer housing. Reconnect the electrical connector from the instrument cluster to the main wiring harness; also connect the separate pink connector. At the speedometer housing, disconnect the pink, black/brown and green electrical connections. Disconnect the electrical connector from the air control unit. Use an ohmmeter and check for continuity between the 3 electrical connectors (disconnected from the back of the speedometer) and the same colored wire terminals within the electrical connector disconnected from the control unit. Check continuity between the pink terminals, the black/brown terminals and the green terminals:

- If there is continuity between all 3 wires, replace the speedometer.
- If there is no continuity within any one of the 3 wires there is an open circuit in the electrical harness between the control unit electrical connector and the electrical wires going to the speedometer. Replace the wiring harness or individual electrical wire that is faulty.

STARTER MOTOR

The engine must be removed from the frame to remove the starter and starter clutch. Refer to Engine section in this supplement and to Chapter Four in the main body of the manual. After engine removal, remove the 2 starter mounting bolts and pull the motor out of the engine crankcase. Reverse this procedure to install the starter motor.

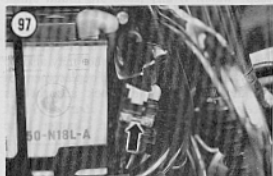

FUSES

There are 6 fuses used on the standard model GL1100 (plus the main fuse). On Interstate models there are 6 fuses (plus the main fuse) with the addition of 3 accessory fuses located within the fairing adjacent to the left-hand front turn signal (Figure 95). All models have a main fuse (fusible link) which is located next to the starter solenoid.

If the main fusible link blows, disconnect the electrical connector (Figure 96) and open the fuse door. Remove the Phillips screws securing the fusible link and replace it (Figure 97). There is a spare link inside the panel.

The remaining fuses are accessible by lifting the cover on the storage area of the top compartment. There are spare fuses attached to the fuse panel also; always carry spares.

Whenever a fuse blows, find out the reason for the failure before replacing the fuse. Usually the trouble is a short circuit in the wiring. This may be caused by worn-through

insulation or a disconnected wire shorted to ground.

CAUTION

Never substitute aluminum foil or wire for a fuse. Never use a higher amperage fuse than specified. An overload could cause a fire and complete loss of the motorcycle.

CHAPTER NINE

FRONT SUSPENSION AND STEERING

FRONT WHEEL

Removal

1. Place the bike on the centerstand.
2. Place a jack under the engine and raise the front wheel off the ground.
3. Remove the speedometer cable set screw and withdraw the cable from the drive unit on the front hub.
4. Remove the bolts securing the left-hand brake caliper to the fork leg. See **Figure 98** for 1980-1982 models or **Figure 99** for 1983 models.

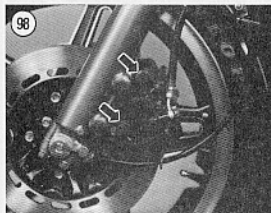

5. Hang the caliper assembly up to the frame or handlebar with wire or a Bungee cord to relieve strain on the hydraulic brake line.
6. Remove the axle holder nuts, lockwashers and washers on each side and remove the axle holders (**Figure 100**).
7. Pull the front wheel down and forward being careful not to damage the studs on the fork sliders.

CAUTION

Do not set the wheel on the disc surface as it may get scratched or warped. Set the wheel on 2 blocks.

NOTE

Insert a piece of vinyl tube or wood into each caliper assembly in place of the disc. That way if the brake lever is inadvertently squeezed, the pistons will not be forced out of the cylinders. If this does happen, the caliper may have to be disassembled to reset the pistons and the system bled. By using the vinyl tube or wood, bleeding the system is not necessary when installing the wheel.

Installation

1. Make sure the axle bearing surfaces of the fork sliders and the lower clamps are free from dirt or small burrs.

2. Remove the vinyl tube or wood from both calipers.

3. Position the wheel in place, carefully inserting the disc between the pads on the right-hand caliper assembly.

4. Make sure that the lug on the speedometer gear box is behind the boss on the left-hand fork leg.

5. Install the axle holders with the "F" arrow facing forward (Figure 101).

6. Install the washers, lockwashers and nuts. Tighten the nuts only finger-tight at this time.

7. Carefully install the left-hand caliper assembly onto the disc.

8A. On 1980-1982 models, install the caliper mounting bolts and torque as follows:

- Caliper upper pivot bolt: 18-22 ft.-lb. (25-30 N•m).
- Caliper lower mounting bolt: 14-18 ft.-lb. (20-25 N•m).

8B. On 1983 models, install the caliper mounting bolts and tighten to the following torque specifications:

- Caliper upper mounting bolt: 25-33 ft.-lb. (35-45 N•m).
- Caliper lower mounting bolt: 14-18 ft.-lb. (20-25 N•m).
- Caliper pivot bolt (if loosened): 18-22 ft.-lb. (25-30 N•m).
- Caliper bolt (if loosened) : 14-18 ft.-lb. (20-25 N•m).

9. Insert a 0.7 mm (0.028 in.) flat feeler gauge between the inside and outside surface of both the right- and left-hand discs and their respective caliper bracket assemblies.

CAUTION

There must be a minimum of 0.7 mm (0.028 in.) clearance or the disc will rub on the caliper bracket assembly and be damaged.

10. If there is insufficient clearance, pull or push on the fork leg(s) until there is sufficient clearance for both discs.

11. Tighten the front axle holder nuts first and then the rear nuts to 13-18 ft.-lb. (18-25 N•m).

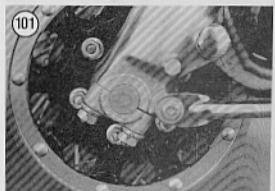
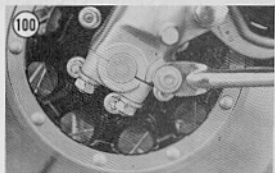
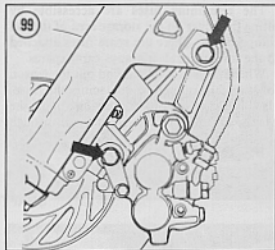

WARNING

The axle holder nuts must be tightened in this manner and to this torque specification. After installation, there will be a slight gap at the rear (Figure 102), with no gap at the front. If done incorrectly, the studs may fail, resulting in loss of control of the bike when riding.

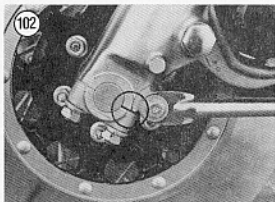

12. Install the speedometer cable into the housing and install the set screw.
13. After the wheel is completely installed, rotate it several times and apply the brake several times to make sure it rotates freely and that the brake pads are against the discs.

TIRE CHANGING

The rim of the 1980-1982 Comstar wheel and the 1983 cast alloy wheel is aluminum and the exterior appearance can easily be damaged. Special care must be taken with tire irons when changing a tire to avoid scratches and gouges to the outer rim surface. Insert scraps of leather between the tire iron and the rim to protect the rim from gouges. Honda offers rim protectors (part No. 0772-0020200) for this purpose that are very handy to use. All models are factory equipped with tubeless tires and wheels designed specifically for use with tubeless tires.

WARNING

Do not install tubeless tires on wheels designed for use only with tube-type tires. Personal injury and tire failure

may result from rapid tire deflation while riding. Wheels for use with tubeless tires are so marked (Figure 103).

TIRE REPAIRS FOR TUBELESS TIRES

Patching a tubeless tire on the road is very difficult. If both beads are still in place against the rim, a can of pressurized tire sealant may inflate the tire and seal the hole. The beads must be against the wheel for this method to work. Another solution is to carry a spare inner tube that could be temporarily installed and inflated. This will enable you to get to a service station where the tire can be correctly repaired. Be sure that the tube is designed for use with a tubeless tire.

Honda (and the tire industry) recommends that the tubeless tire be patched from the inside. Therefore, do not patch the tire with an external type plug. If you find an external patch on a tire, it is recommended that it be patch-reinforced from the inside.

Due to the variations of material supplied with different tubeless tire repair kits, follow the instructions and recommendations supplied with the repair kit.

Honda recommends that the valve stem be replaced each time the tire is removed from the wheel.

STEERING HEAD AND STEM

Disassembly

Refer to **Figure 104** for this procedure.

1. Remove the front wheel as described in this section of the supplement.
2. On Interstate models, remove the front fairing as described in the Chapter Twelve section of this supplement.
3. Remove the handlebar as described in the Chapter Nine in the main body of this book.
4. On standard models, remove the headlight as described in the Chapter Seven section of this supplement.
5. Disconnect all electrical connectors within the headlight case. Remove the headlight case mounting nuts and remove the headlight case.

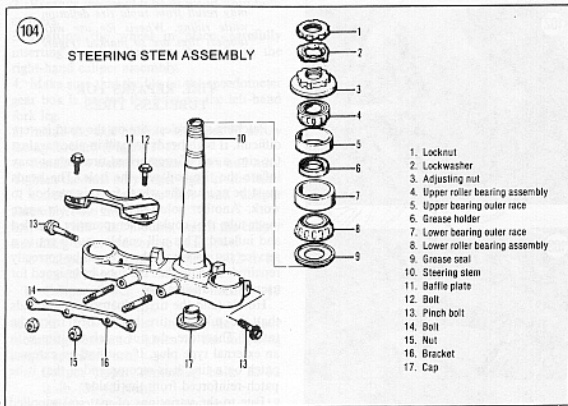

6. Disconnect the tachometer and speedometer drive cables from their respective instruments.

7. Remove the nuts and washers securing the instrument cluster and remove the instrument cluster.

8. Remove the nuts and washers securing the ignition switch and remove the ignition switch assembly.

9. Remove the front fork air hose connector between the 2 forks.

10. Remove the steering stem nut and washer.

11. Loosen the upper and lower fork bridge bolts and the pinch bolt for the steering stem.

12. Remove the front forks as described in this section of the supplement.

13. Remove the 3-way hydraulic brake joint from the lower portion of the steering stem assembly.

NOTE

Do not disconnect any brake hydraulic lines; just move the 3-way joint out of the way.

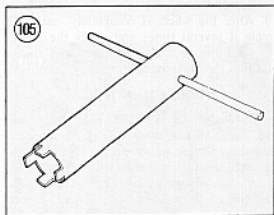

14. Remove the upper fork bridge.

15. Bend down the tabs of the lockwasher from the grooves in the locknut. Remove the locknut and lockwasher. Discard the lockwasher. To loosen the locknut, use a large drift and hammer or use the easily improvised tool shown in **Figure 105**.

16. Remove the steering stem adjusting nut and lower the steering stem assembly down and out of the steering head. Don't worry

about catching any loose steel balls as the steering stem is equipped with assembled roller bearings.

NOTE

Remove the steering stem adjusting nut in the same manner as the locknut.

Inspection

1. Clean the bearing races in the steering head and the bearings with solvent.
2. Check the welds around the steering head for cracks and fractures. If any are found, have them repaired by a competent frame shop or welding service.
3. Check the roller bearings for pitting, scratches or discoloration indicating wear or corrosion.
4. Check the races for pitting, galling and corrosion. If any of these conditions exist, replace the races as described under *Bearing Race Replacement* in this section of this supplement.
5. Check the steering stem for cracks and check its race for damage or wear. Replace if necessary.

Steering Head and Stem Assembly

Refer to **Figure 104** for this procedure.

1. Make sure both steering head bearing outer races are properly seated in the steering head tube.
2. Pack the bearing cavities of both roller bearings with bearing grease. Coat the outer races (within the steering head) with bearing grease also.
3. Install the steering stem, with the lower roller bearing in place, into the steering head tube and hold it firmly in place.
4. Install the upper roller bearing assembly.
5. Install the steering stem adjusting nut and tighten it to 11 ft.-lb. (1.5 mkg).
6. Turn the steering stem from lock to lock about 5-6 times to help seat the bearings.
7. Repeat Step 5 and Step 6 twice more to make sure the bearings are properly seated.

NOTE

If the adjusting nut cannot be tightened any additional amount after turning the steering stem back and forth,

remove the adjusting nut and inspect the threads for burrs or dirt. If dirty clean it out; if damaged replace the adjusting nut with a new one.

8. Install a new lockwasher and insert 2 of the tabs into the grooves in the adjusting nut. Always install a new lockwasher; never reinstall a used one as the tabs may break off making the lockwasher ineffective.
9. Install the locknut and hand-tighten it. Further tighten the locknut only until the grooves align with 2 of the tabs of the lockwasher. Bend the 2 tabs up into the grooves in the locknut.

NOTE

If the grooves in the locknut will not align easily with 2 of the tabs of the lockwasher, remove the locknut, turn it over and reinstall the locknut. Repeat Step 9.

NOTE

Steps 10-16 must be performed in this order to assure proper upper and lower fork bridge to fork alignment.

10. On standard models, apply a light coat of grease to the rubber inserts in the top and bottom of the headlight bracket.
11. On standard models, position the fork tube in the lower fork bridge and twist the fork tube as it enters the rubber insert in both the lower and upper portion of the headlight bracket. On Interstate models, simply install the fork tube into the lower fork bridge.
12. Install the upper fork bridge, washer and the steering stem nut. Tighten the stem only finger-tight at this time.
13. Position the fork tubes so that the top of the fork tube aligns with the top surface of the upper fork bridge. Position the top fork caps/air valve assemblies so the air hose inlets align with the punch marks on the upper fork bridge.
14. Tighten the lower fork bridge bolts to 25 ft.-lb. (3.5 mkg).
15. Tighten the stem nut to 72 ft.-lb. (10.0 mkg).
16. Tighten the upper fork bridge bolts to 16 ft.-lb. (2.2 mkg).

17. Tighten the steering stem pinch bolt to 8 ft.-lb. (1.1 mkg).
18. Install the 3-way hydraulic brake line assembly to the lower portion of the steering stem assembly.
19. Install the ignition switch and connect the electrical connector to the ignition switch.
20. Complete the installation of the front forks as described in this section of the supplement.
21. Complete installation by reversing Steps 1-7 of *Steering Stem Disassembly* in this section of the supplement.

Steering Stem Adjustment

If play develops or there is binding in the steering system, it may only require adjustment. However, don't take a chance on it. Disassemble the steering stem assembly as described in this section and look for possible damage.

FRONT FORKS

The front suspension uses a spring controlled, hydraulically damped, telescopic fork with air assist. The anti-dive feature built into 1983 fork legs is covered separately in this section of the supplement.

Before suspecting major trouble, drain the front fork oil and refill with the proper type and quantity; refer to Chapter Three section of this supplement. If you still have trouble, such as poor damping, a tendency to bottom or top out or leakage around the rubber seals, follow the service procedures in this section.

To simplify fork service (and to prevent the mixing of parts on 1983 models), the legs should be removed, serviced and installed individually.

Removal

1. Rest the bike on the centerstand.
2. On Interstate models, remove the front fairing as described in the Chapter Twelve section of this supplement.
3. Remove both side covers, the seat and the top storage compartment.
4. Remove the front fork air valve cap and bleed off all air pressure from each fork by depressing the valve stem (A, Figure 106).

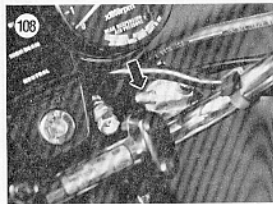
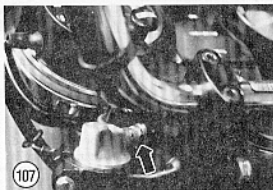
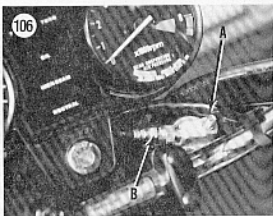

WARNING

Always bleed off all air pressure; failure to do so may cause personal injury when disassembling the fork.

NOTE

Release the air pressure gradually. If released too fast, fork oil will spurt out with the air. Protect your eyes and clothing accordingly.



5. Disconnect the air hose first from the top fork cap/air valve assembly that is fitted with the air hose connector (B, Figure 106) and then from the other top fork cap/air valve (Figure 107).

NOTE

The air hose connector may have been installed on either the right- or left-hand fork leg upon assembly by the dealer or the last time it was serviced. It does not make any difference which side it is fitted to.

6. Unscrew the air hose connector from the top fork cap/air valve assembly (Figure 108).
 7. Remove the front wheel as described in this section of the supplement.
 8. Loosen the upper and lower fork bridge bolts.
 9. Remove the bolts securing the front fender and remove the fender.
 10. On 1983 models, remove the Allen bolts holding the fork brace between the 2 fork sliders.
 11. Remove the fork tube. It may be necessary to slightly rotate the fork tube while pulling it down and out.

NOTE

On standard models, the brackets that hold the headlight assembly have rubber inserts. If you are unable to withdraw the fork tube from these items, spray around the perimeter of the rubber inserts with silicone spray or contact cleaner. This should lubricate the rubber sufficiently for fork tube removal.

Installation

1. On standard models, apply a light coat of grease to the rubber inserts in the top and bottom of the headlight bracket.
2. On standard models, position the fork tube in the lower fork bridge and twist the fork tube as it enters the rubber insert in both the lower and upper portion of the headlight bracket. On Interstate models, simply install the fork into the lower and upper fork bridge.
3. Position the fork tubes so that the top of the fork tube aligns with the top surface of the upper fork bridge. Position the top fork caps/air valve assemblies so the air hose inlets align with the punch marks on the upper fork bridge.
4. Apply a light coat of grease to new O-ring seals (Figure 109) on the air hose connector and air hose.
5. Install the air hose connector and tighten to 4 ft.-lb. (0.6 mkg).
6. Install the air hose first to the top fork cap/air valve assembly and tighten to 4 ft.-lb. (0.6 mkg). Install the air hose to the air hose connector and tighten the fitting to 13 ft.-lb. (1.8 mkg).

NOTE

Hold onto the air hose connector (attached to the top fork cap/air valve assembly) with a wrench while tightening the air hose fitting.

7. Tighten the lower fork bridge bolts to 25 ft.-lb. (3.5 mkg).
8. Tighten the upper fork bridge bolts to 16 ft.-lb. (2.2 mkg).
9. Install the front fender and tighten the bolts securely. Install the fork brace and tighten the Allen bolts securely.
10. Install the front wheel as described in this section of the supplement.
11. Inflate the forks to 14-21 psi (1.0-1.5 kg/cm²). Do not use compressed air; only use a small hand-operated air pump like the one shown in Figure 110.

WARNING

Never use any type of compressed gas as an explosion may be lethal. Never heat the fork assembly with a torch or

place it near an open flame or extreme heat as this will also result in an explosion.

12. With both wheels on the ground and the front brake applied, pump the handlebar and the front forks up and down several times. Place the bike on the centerstand and check the front fork air pressure. Readjust the air pressure if necessary.

Overhaul (1980-1982)

Disassembly on this model should be entrusted to a Honda dealer. In order to disassemble the fork, the fork seal in the slider must be removed with special Honda tools and a hydraulic press.

Do not try to disassemble the fork tube from the slider with force as many internal components will be damaged. A considerable amount of money can be saved by removing the fork assemblies yourself and taking them to a Honda dealer for service.

Disassembly (1983)

Refer to Figure 111 during the disassembly and assembly procedures.

1. Clamp the slider in a vise with soft jaws.
2. Remove the Allen head screw and gasket from the bottom of the slider.

NOTE

This screw has been secured with Loctite and is often very difficult to remove because the damper rod will turn inside the slider. It sometimes can be removed with an air impact driver. If you are unable to remove it, take the fork tubes to a dealer and have the screws removed.

3. Hold the upper fork tube in a vise with soft jaws and loosen the fork top cap bolt/air valve assembly (if it was not loosened during the fork removal sequence).

WARNING

Be careful when removing the fork top cap bolt/air valve assembly as the springs are under pressure. Protect your eyes accordingly.

4. Remove the fork top cap bolt from the fork.

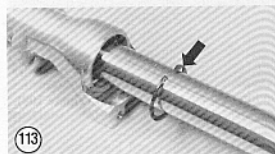
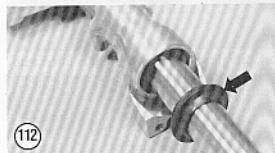

5. Remove the upper short fork spring "A," the spring seat and the lower long spring "B."
6. Remove the fork from the vise, pour the fork oil out and discard it. Pump the fork several times by hand to expel most of the remaining oil.
7. Remove the dust seal (Figure 112).

NOTE

The Honda factory has determined that the sponge seal may work its way down the oil seal and give the appearance of a worn or leaking oil seal. Therefore do not reinstall the sponge seal and plastic washer under the dust seal during the assembly procedure. If you purchase a new seal kit that still has these 2 parts in it; discard them, they are not to be used.

111

FRONT FORK (1983)

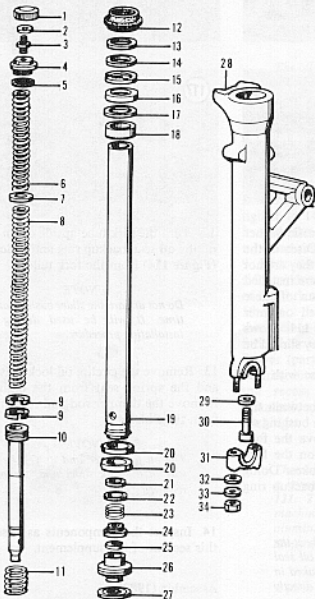

1. Top cap
2. O-ring seal
3. Air valve
4. Fork top cap bolt
5. O-ring seal
6. Upper short spring "A"
7. Spring seat
8. Lower long spring "B"
9. Damper rod seal
10. Damper rod
11. Rebound spring
12. Dust seal
13. Sponge seal—discard
14. Plastic washer—discard
15. Snap ring
16. Oil seal
17. Backup plate
18. Slider bushing
19. Slider
20. Fork tube bushing
21. Washer
22. Spring seat
23. Spring
24. Oil lock valve
25. Ring stopper
26. Oil lock piece
27. O-ring
28. Fork slider
29. Washer
30. Allen bolt
31. Axle holder
32. Washer
33. Lockwasher
34. Nut

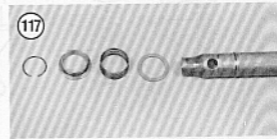
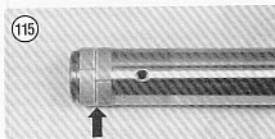
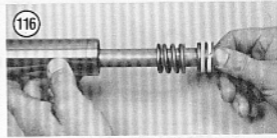
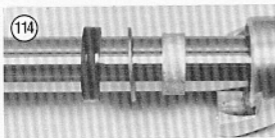

8. Remove the sponge seal, the plastic washer and the circlip (Figure 113). Discard the sponge seal and plastic washer as they are not to be reinstalled. These 2 parts were installed on the early 1983 production run of these models and then were eliminated on later 1983 production bikes. Figure 111 shows these 2 parts and indicates that they should be discarded.

9. Install the fork slider in a vise with soft jaws.

10. There is an interference fit between the bushing in the fork slider and the bushing on the fork tube. In order to remove the fork tube from the slider, pull hard on the fork tube using quick in and out strokes. Doing this will withdraw the bushing, backup ring and oil seal from the slider.

NOTE

It may be necessary to slightly heat the area on the slider around the oil seal prior to removal. Use a rag soaked in hot water; do not apply a flame directly to the fork slider.

11. Withdraw the fork tube from the slider.

NOTE

Do not remove the fork tube bushing unless it is going to be replaced. Inspect it as described in this section of the supplement.

12. Turn the fork tube upside down and slide off the oil seal, backup ring and slider bushing (Figure 114) from the fork tube.

NOTE

Do not discard the slider bushing at this time. It will be used during the installation procedure.

13. Remove the circlip, oil lock valve, spring and the spring seat from the damper rod. Remove the damper rod and rebound spring from the slider.

NOTE

The oil lock piece and its O-ring will stay in the fork slider and cannot be removed.

14. Inspect the components as described in this section of the supplement.

Assembly (1983)

1. Coat all parts with fresh DEXRON ATF (automatic transmission fluid) or fork oil prior to installation.
2. If removed, install a new fork tube bushing (Figure 115).
3. Install the rebound spring onto the damper rod and insert this assembly into the fork tube

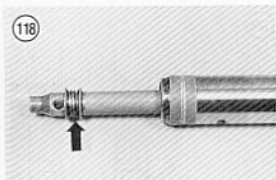

(Figure 116). Onto the damper rod install the spring seat, the spring, the oil lock valve and the circlip. Refer to Figure 117 and Figure 118.

4. Temporarily install the lower long fork spring "B," spring seat, upper short spring "A" and fork top cap bolt/air valve assembly to hold the damper rod in place.

NOTE

The oil lock piece is still inside the fork slider.

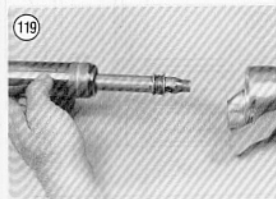

5. Install the upper fork assembly into the slider (Figure 119).

6. Make sure the gasket is on the Allen head screw.

7. Apply Loctite Lock N' Seal to the threads of the Allen head screw prior to installation. Install it in the fork slider (Figure 120) and tighten to 14 ft.-lb. (20 N•m).

8. Slide the fork slider bushing down the fork tube and rest it on the slider.

9. Slide the fork slider backup ring (flange side up) down the fork tube and rest it on top of the fork slider bushing.

10. Place the old fork slider bushing on top of the backup ring. Drive the bushing into the fork slider with Honda special tool Fork Seal Driver (part No. 07947-4630100). Drive the bushing into place until it seats completely in the recess in the slider. Remove the installation tool and the old fork slider bushing.



NOTE

The slider bushing can be driven in with a homemade tool as shown in Figure 121. This tool can be made at a machine shop from a piece of aluminum. Refer to Figure 122 for dimensions.

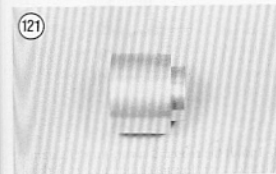

NOTE

A piece of 2 in. galvanized pipe can also work as a tool. If both ends are threaded (a close nipple pipe fitting), wrap one end with duct tape (Figure 123) to prevent the threads from damaging the interior of the slider.

11. To prevent damage to the inside of the new fork seal during installation, wrap the

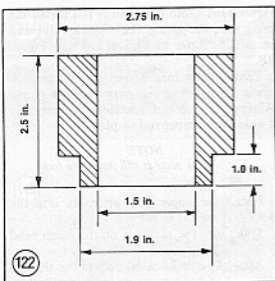

groove in the top of the fork tube with clear tape (something smooth and non-abrasive—do not use duct or masking tape).

12. Coat the new seal with DEXRON ATF or fork oil. Position the seal with the marking facing upward (Figure 124) and slide it down onto the fork tube. Drive the seal into the slider with Honda special tool Fork Seal Driver (part No. 07947-4630100); refer to Figure 125. Drive the oil seal in until the groove in the slider can be seen above the top surface of the oil seal. Remove the tape from the top of the fork tube.

NOTE

The slider seal can be driven in with a homemade tool described in the NOTES following Step 11.

13. Install the circlip (Figure 113) with the sharp side facing up. Make sure the circlip is completely seated in the groove in the fork slider.

14. Install the dust seal. Remember do not install the plastic washer and the sponge seal. Discard them if they are included in a new seal kit that you may have purchased. Refer to the Note regarding these items in the Disassembly procedure.

NOTE

Figure 126 shows the correct placement of all components installed during Steps 8-14.

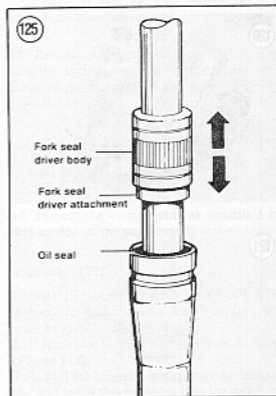
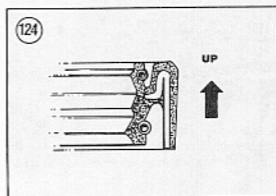
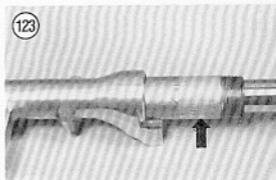

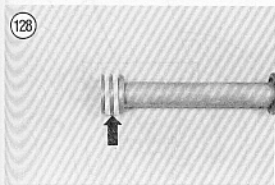
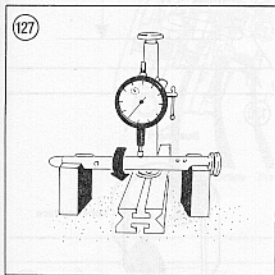
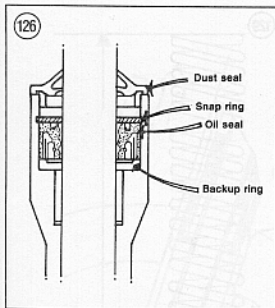

15. Remove the fork top cap bolt, both springs and the spring seat.
16. Fill the fork tube with 9.8 oz. (290 cc) of DEXRON ATF or fork oil.
17. Install the lower long fork spring "B" with the closer wound coils toward the top of the fork tube.
18. Install the spring seat and the upper short spring "A."
19. Inspect the O-ring seal on the fork top cap bolt/air valve assembly; replace if necessary.
20. Install the fork top cap bolt/air valve assembly while pushing down on the springs. Start the bolt slowly, don't cross thread it.
21. Place the slider in a vise with soft jaws and tighten the top fork cap bolt/air valve assembly to 17 ft.-lb. (23 N•m).
22. Perform Steps 6-22 for the other fork assembly.
23. Install the fork assemblies as described in this section of the supplement.

Inspection (1983)

1. Thoroughly clean all parts in solvent and dry them. Check the fork tube for signs of wear or scratches.
2. Check the damper rod for straightness. Figure 127 shows one method. The rod should be replaced if the runout is 0.2 mm (0.008 in.) or greater.
3. Carefully check the damper rod and piston ring(s) for wear or damage (Figure 128). Replace if necessary.
4. Check the upper fork tube for straightness. If bent or severely scratched, it should be replaced.
5. Check the lower slider for dents or exterior damage that may cause the upper fork tube to hang up during riding. Replace if necessary.
6. Measure the uncompressed length of the fork springs (not rebound spring) as shown in Figure 129. If the spring(s) has sagged to the following service limit dimensions the spring(s) must be replaced:
 - a. Upper short spring "A": 4.17 in. (106.0 mm).
 - b. Lower long spring "B": 18.22 in. (462.8 mm).

7. Inspect the slider and fork tube bushings. If either is scratched or scored they must be replaced. If the Teflon coating is worn off so that the copper base material is showing on approximately 3/4 of the total surface, the bushing must be replaced. Also check for distortion on the check points of the backup ring; replace as necessary. Refer to Figure 130.

8. Any parts that are worn or damaged should be replaced. Simply cleaning and reinstalling unserviceable components will not improve performance of the front suspension.

ANTI-DIVE FRONT SUSPENSION (1983)

Both the standard and Interstate models have the TRAC (Torque Reactive Anti-dive Control) system integrated into both fork legs (Figure 131). The system reacts to the forward weight transfer of the bike and rider(s) during braking. This system is strictly mechanical as opposed to some other systems that rely on brake fluid pressure.

The caliper assembly is pivot-mounted on the fork slider. As the brake is applied, the caliper tries to move or ride with the disc, thus pivoting the caliper assembly toward the TRAC unit. This action forces a tab on the caliper assembly against the piston and main spring in the TRAC unit.

As the TRAC piston moves in, it uncovers an oil control orifice to restrict the fork leg's compression-damping passageway, thus diverting the fork oil through a small secondary valve (oil control orifice). As internal damping action increases, the fork resists compression and the suspension does not dive. The harder the brake is applied, the further the valve moves and the greater the anti-dive action.

If the forks encounter a bump while the brake is applied, the hydraulic pressure inside the fork leg progressively forces the main valve to open. This allows the fork to move to absorb the shock.

The secondary valve is adjustable to control the damping effect rate. There are 4

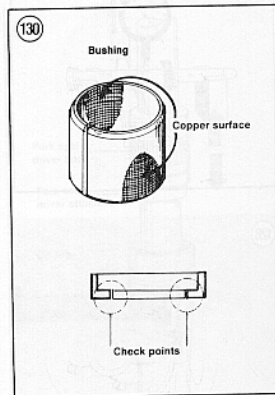
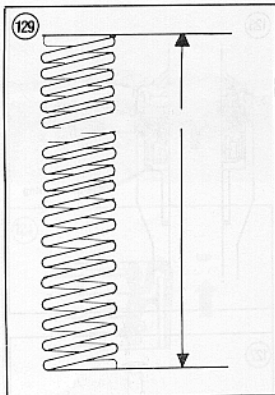

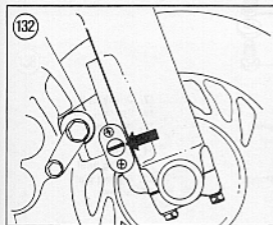
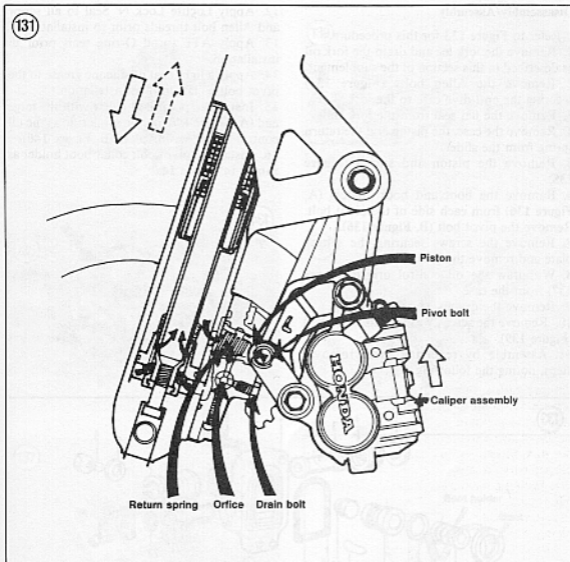

different settings, from soft to extra firm; the adjustment procedure is covered in this section of the supplement.

Damping Adjustment

The fork damping rate can be adjusted to 4 different settings from soft to extra firm. The oil control orifice has 4 different diameter holes that control the flow rate of the fork oil to either increase or decrease the damping rate.

Turn the oil control orifice (Figure 132) with a dime or screwdriver to the desired damping position.

Disassembly/Assembly

Refer to **Figure 133** for this procedure.

1. Remove the fork leg and drain the fork oil as described in this section of the supplement.
2. Remove the Allen bolts (**Figure 134**) securing the anti-dive case to the fork slider.
3. Remove the flat seal from the fork slider.
4. Remove the case, the piston and the return spring from the slider.
5. Remove the piston and spring (**Figure 135**).
6. Remove the boot and boot holders (A, **Figure 136**) from each side of the pivot bolt. Remove the pivot bolt (B, **Figure 136**).
7. Remove the screws securing the setting plate and remove the setting plate.
8. Withdraw the oil control orifice (**Figure 137**) from the case.
9. Remove the drain screw (**Figure 138**).
10. Remove the screw, washer and check ball (**Figure 139**).
11. Assemble by reversing these removal steps, noting the following.

12. Apply Loctite Lock N' Seal to all screw and Allen bolt threads prior to installation.
13. Apply ATF to all O-ring seals prior to installation.
14. Apply a light coat of silicone grease to the pivot bolt collar prior to installation.
15. Install the pivot bolt collar with the large end (A, **Figure 140**) on the same side as the oil control orifice setting plate (B, **Figure 140**).
16. Install the pivot bolt collar boot holder as shown in **Figure 141**.

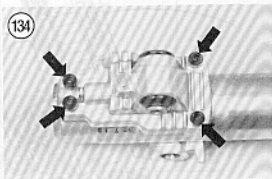

133

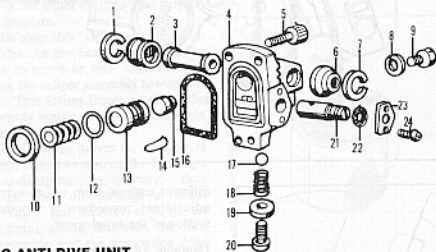

TRAC ANTI-DIVE UNIT

- | | | |
|----------------|--------------------|-------------------|
| 1. Boot holder | 9. Bolt | 17. Check ball |
| 2. Boot | 10. Flat seal | 18. Spring |
| 3. Pivot bolt | 11. Return spring | 19. Washer |
| 4. Case | 12. O-ring seal | 20. Screw |
| 5. Bolt | 13. Piston | 21. Orifice |
| 6. Boot | 14. Pin | 22. O-ring seal |
| 7. Boot holder | 15. Rubber stopper | 23. Setting plate |
| 8. Lockwasher | 16. Seal | 24. Screw |

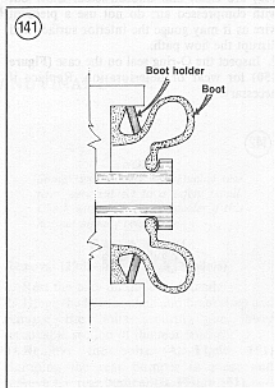
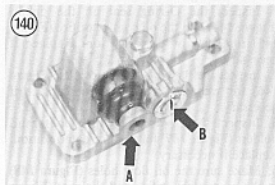
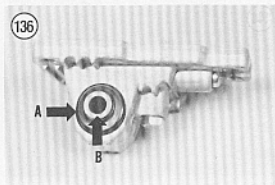
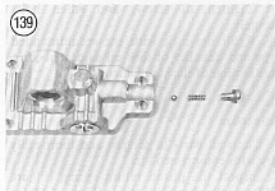
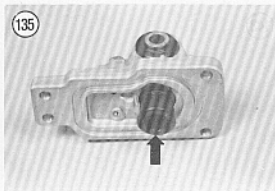

17. Tighten all screws and Allen bolts securely.

18. Refill the fork with the recommended type and quantity of fork oil as described in this section of the supplement.

Inspection

1. Clean all parts in solvent and thoroughly dry with compressed air.
2. Inspect the piston return spring (Figure 142) and the check ball spring (Figure 143) for wear or damage.
3. Inspect the O-ring seal on the piston (Figure 144) and the oil control orifice (Figure 145) for wear or deterioration. Replace if necessary.
4. Inspect the flat seal on the fork leg (Figure 146) for wear or deterioration. Replace if necessary.
5. Inspect the pivot bolt collar boots and holders (Figure 147) for wear or deterioration. Replace if necessary.
6. Make sure the oil flow holes (Figure 148) in the oil control orifice and the case (Figure 149) are clean and unobstructed. Blow out with compressed air; do not use a piece of wire as it may gouge the interior surface and disrupt the flow path.
7. Inspect the O-ring seal on the case (Figure 150) for wear or deterioration. Replace if necessary.

142



143

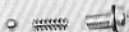

144



145

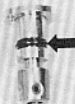

146



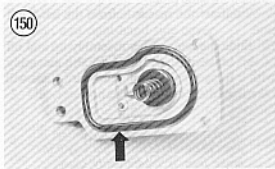
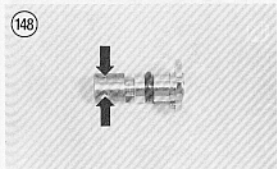
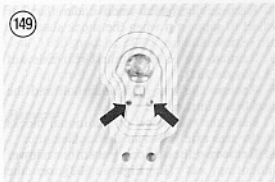
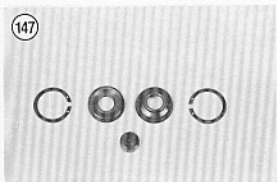

CHAPTER TEN

REAR SUSPENSION AND FINAL DRIVE

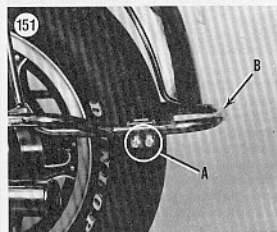
**NOTE**

Some 1982 models with Dunlop rear tires were subject to a safety recall. Check with your Honda dealer if this has not already been done.

REAR WHEEL**Removal (1982-on Interstate Models)**

1. Rest the bike on the centerstand.
2. Hinge the license plate and bracket up and remove the bolts securing the lower removable section of the rear fender.
3. Remove the bolts (A, Figure 151) clamping the rear bumper in place and remove the rear bumper (B, Figure 151).

4. Place a block(s) of wood under the rear wheel to support it when the shock absorbers are removed.
5. Remove the cotter pin and rear axle nut (A, Figure 152).
6. Remove the rear axle pinch bolt and the rear brake dust cover.
7. Raise the rear wheel on additional blocks so the rear axle will clear the muffler.
8. Remove the shock absorber lower mounting nut (B, Figure 152) on the right-hand side and the lower mounting bolt on the left-hand side.
9. Withdraw the rear axle from the left-hand side.
10. Slide the rear caliper assembly up and off of the brake disc and support the assembly with a Bungee cord or piece of wire. This will take the strain off the brake hose.

NOTE

Insert a piece of wood in the caliper in place of the brake disc. That way if the brake lever is inadvertently squeezed, the piston will not be forced out of the cylinder. If this does happen, the caliper may have to be disassembled to reseal the piston and the system bled. By using the piece of wood, bleeding the brake is not necessary when installing the wheel.

11. Remove the nuts and washers securing the final drive unit to the swing arm.
12. Pull the rear wheel assembly to the rear and separate the final drive unit from the rear wheel. Lay the final drive unit on some clean rags with the spline side down. If set down on the opposite side the oil may drain out of the breather cap.
13. Remove the rear wheel.

Installation (1982-on Interstate Models)

1. Apply a light coat of molybdenum disulfide grease to the splines of the final drive and the rear wheel hub.
2. Install the final drive unit into the hub. Make sure the splines mesh properly and that the unit is seated all the way into the hub.
3. Install the rear wheel and final drive unit into position. Make sure the splines of the final drive unit mesh properly with the splines

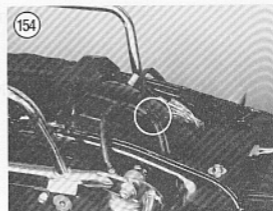
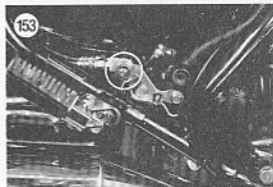
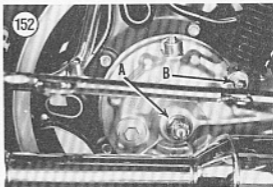

- of the drive shaft. Slightly rotate the rear wheel if necessary for proper engagement.
4. Remove piece of wood from between brake pads. Carefully slide the rear brake caliper assembly onto the brake disc and install the rear axle from the left-hand side.
5. Install the rear axle nut. Place a drift or screwdriver into the hole in the left-hand side of the rear axle. This will prevent the axle from turning while tightening the axle nut.

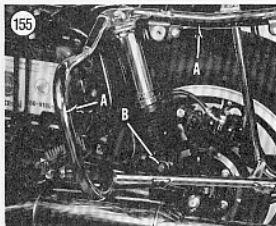

Tighten the axle nut to the following torque specifications:

- a. 1980-1982 models: 65 ft.-lb. (9.0 mkg).
 - b. 1983 models: 69 ft.-lb. (95 N·m).
6. Install the washers and nuts on the final drive unit and tighten the nuts to 25-33 ft.-lb. (3.5-4.5 mkg).
 7. Install the axle pinch bolt and tighten to 17-21 ft.-lb. (2.4-2.9 mkg).
 8. Position the lower portion of the rear shock absorbers, install the bolt or nut and tighten to 22-29 ft.-lb. (3.0-4.0 mkg).
 9. Remove the wood block from under the rear wheel.
 10. Install the removable portion of the rear fender.

SHOCK ABSORBERS

Air assist shocks are used on model GL1100 to provide the desired ride for various load conditions. There is no spring in this type of shock and disassembly and service should be entrusted to a dealer.

Shock Absorber Adjustment

The only adjustment for this type of shock is by varying the air pressure in the shock units. The air pressure for both the front forks and rear shocks can vary with different load and roadway conditions. Less air pressure results in a softer ride for light loads and smooth roadways. Increased air pressure will result in a harder ride and is recommended when carrying heavy loads or when riding on rough terrain.

Recommended air inflation pressure is as follows:

- a. 1980 models: 28-43 psi (2.0-3.0 kg/cm²).
- b. 1981-1982 models: 28-57 psi (2.0-4.0 kg/cm²).
- c. 1983 models: 0-57 psi (0-4.0 kg/cm²).

Removal

Removal and installation of the rear shocks are easier if they are done separately. The remaining unit will support the rear of the bike and maintain the correct relationship between the top and bottom shock mounts.

1. Place the bike on the centerstand; remove the seat and right-hand side cover.
2. On Interstate models, remove both saddle bags as described in the Chapter Twelve section of this supplement.
3. Unscrew the air valve cap and depress the air valve stem. *Bleed off all air pressure within the system.*
4. Unscrew the locknut (Figure 153) securing the 3-way joint to the frame.
5. On 1982 models only, disconnect the low air pressure warning light electrical wire from the 3-way joint.
6. Hold onto the air hose connectors in the 3-way joint and unscrew both air hoses.
7. Unhook the hose retaining straps (Figure 154) on the rear fender and on the rear of the fuel tank. Pull the air hoses up and out from behind the frame member.
8. On standard models, remove the rear hand rail.
9. On Interstate models, remove the luggage rack and right- and left-hand rear bumpers (A, Figure 155) as described in the Chapter Twelve section of this supplement.
10. Remove the shock lower mounting nut (right-hand side) or bolt (left-hand side). See B, Figure 155.
11. Pull the unit straight off the upper stud and remove the shock unit and its air hose.

NOTE

Do not lay the shock absorber on its side as the fluid will leak out the air hose. Keep it in its normal upright position.

12. After reinstalling the first unit, repeat for the other side.

Inspection

Service to this type of shock is limited to removal, replacement and installation of the shock units and their related air hose components. The disassembly of the damper unit should be entrusted to a dealer.

Refer to **Figure 156** for this procedure.

1. Slide off the rubber boot on the base of the shock and inspect the lower portion for fluid leakage. If any leakage is present the internal oil seal is damaged and must be replaced or the entire shock unit must be replaced. Take the shock unit to a dealer for disassembly and inspection.
2. Reinstall the rubber boot if the shock unit is okay.
3. Unscrew the air hose from the shock absorber unit.
4. Inspect the rubber air hoses for cracking and chafing. Replace as necessary to avoid a possible air loss problem.
5. If an air leak is suspected at the air valve, unscrew the valve from the 3-way joint and replace the O-ring.
6. Replace the O-ring seals at the hose ends, on the connectors and the air valve. Rubber O-rings tend to lose their sealing ability with age and when subjected to heat.

NOTE

Replace all O-ring seals whenever any component relating to the rear shocks is removed.

7. Apply a light coat of grease to all new O-ring seals prior to installation.
8. Install a new O-ring seal onto the air hose. Install the air hose onto the shock absorber and tighten to 4 ft.-lb. (0.6 mkg).

Installation

1. Install the shock absorber unit onto the frame. Be sure to install a washer onto the lower mounting stud (right-hand side only) prior to installing the shock absorber. Install the lower mounting nut or bolt.
2. On standard models, install the rear hand rail.
3. On Interstate models, install the luggage rack and right- and left-hand rear bumpers as

described in the Chapter Twelve section of this supplement.

NOTE

Be sure to install the luggage rack and rear grab handle on the outside surface of the shock absorber.

4. Tighten the mounting nuts and bolt to 25 ft.-lb. (3.5 mkg).
5. Correctly position the air hoses through the frame and attach both hoses to the 3-way connector. Hold onto the connector with a wrench and tighten the hose fittings to 13 ft.-lb. (1.8 mkg). Secure the hose fittings to the rear fender and to the back of the fuel tank.
6. Position the 3-way joint in the frame and install the locknut. Tighten the locknut securely.

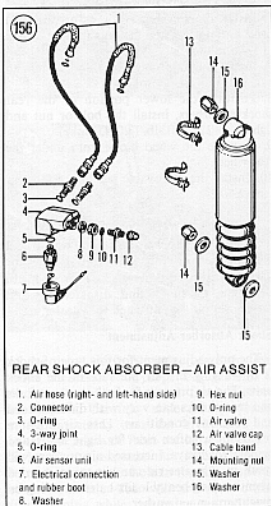

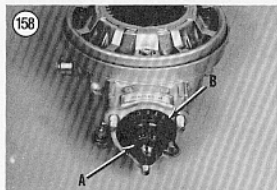
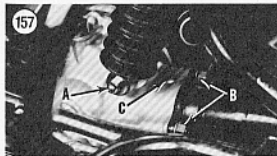

7. On 1982 only models, connect the electrical switch wire.
8. Inflate the rear shocks to the recommended air pressure as follows:
 - a. 1980 models—28-43 psi (2.0-3.0 kg/cm²).
 - b. 1981-1982 models—28-57 psi (2.0-4.0 kg/cm²).
 - c. 1983 models—0.0-57 psi (0-4.0 kg/cm²).
9. Install the air valve cap.
10. Install the seat and side cover.

FINAL DRIVE

Removal/Installation

1. Remove the rear wheel as described in Chapter Ten in the main body of this book.

NOTE

On 1982-on Interstate models, remove the rear wheel as described in this section of the supplement.

2. Remove the nut and outer washer (A, Figure 157) securing the lower portion of the shock absorber. Pull the shock off of the mounting stud on the final drive unit and remove the inner washer.

3. Remove the 3 nuts and washers (B, Figure 157) securing the final drive unit to the swing arm.
4. Pull the final drive unit to the rear until it is free from the drive shaft splines.
5. Apply a light coat of molybdenum disulfide grease (NGLI No. 2 grease with MOS2- additive) to the splines of the drive shaft joint and the pinion joint splines.
6. Make sure the O-ring seal (A, Figure 158) is in place on the pinion joint.
7. Install the final drive unit onto the swing arm. Install the washers and nuts only finger-tight at this time. Do not tighten the nuts until the rear wheel and rear axle are in place.
8. Install the rear wheel as described in Chapter Ten in the main body of this book.

NOTE

On 1982-on Interstate models, install the rear wheel as described in this section of the supplement.

CAUTION

Do not tighten the rear axle nut until the final drive unit case nuts are tightened.

9. Tighten the final drive nuts in a crisscross pattern to 29 ft.-lb. (4.0 mkg).
10. Tighten the rear axle nut to 65 ft.-lb. (9.0 mkg) and install a new cotter pin. Bend the ends over completely. Tighten the axle pinch bolt to 20 ft.-lb. (2.7 mkg).
11. Onto the shock absorber stud on the final drive unit, install the inner washer, shock absorber lower portion, washer and nut. Tighten the nut to 25 ft.-lb. (3.5 mkg).
12. Apply approximately 90 grams of molybdenum disulfide grease (NGLI No. 2) to the drive shaft joint zerk fitting (C, Figure 157).
13. Fill the final drive unit with the correct amount and type of gear oil. Refer to *Changing Final Drive Oil* in the Chapter Three section of this supplement.

Disassembly/Inspection/Assembly

The final drive unit requires a considerable number of special Honda tools for disassembly and assembly. The price of all of

these tools could be more than the cost of most repairs or seal replacement by a dealer.

Figure 159 shows all of the internal components of the final drive unit.

1. Check that the locking tabs on the dust cover (Figure 160) are in place (not broken) and snug against the bolts. If any of the tabs are broken the dust cover should be replaced as follows:

- Bend down the locking tabs and remove the bolts securing the dust cover. Remove the dust cover.
- Install a new dust cover and tighten the bolts securely.
- Bend the locking tabs up against the flats of all of the bolts. Make sure they are snug against the bolts to prevent the bolts from working loose during travel.

2. Inspect the condition of the splines on the final driven ring gear (Figure 161). If they are damaged or worn the ring gear must be replaced.

NOTE

If these splines are damaged also inspect the condition of the splines on the rear wheel final driven flange; it may also need to be replaced.

3. Inspect the condition of the splines on the pinion joint (B, Figure 158). If they are damaged or worn the pinion joint must be replaced.

NOTE

If these splines are damaged also inspect the condition of the splines in the drive shaft joint; it may also need to be replaced.

159

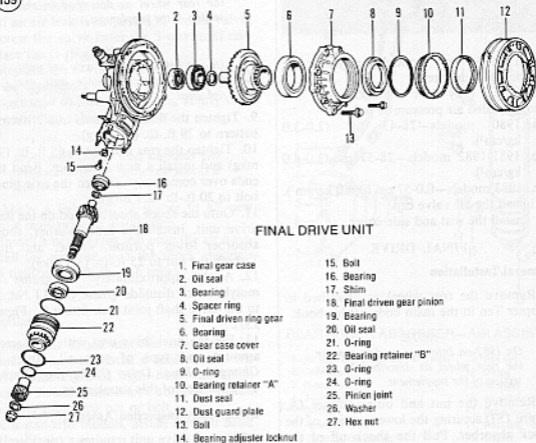

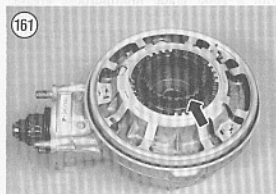
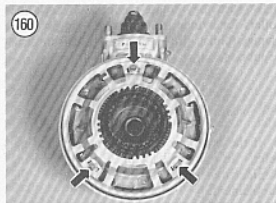

4. Check that gear oil is not leaking from either side of the unit (ring gear side or pinion joint side). If there are traces of oil leakage, take the unit to a dealer for oil seal replacement.

SWING ARM

In time, the roller bearings will wear and will have to be replaced. The condition of the bearings can greatly affect handling performance and if worn parts are not replaced they can produce erratic and dangerous handling. Common symptoms are wheel hop, pulling to one side during acceleration and pulling to the other side during braking.

A Honda special tool is required for loosening and tightening of the pivot adjusting bolt locknut. The tool is the Swing Arm Pivot Locknut Wrench (Honda part No. 07908-4690001). This tool is required for proper and safe installation of the swing arm. If this locknut is not tightened to the correct

torque specification it may allow the adjusting bolt to work loose. This could result in the swing arm working free from the left-hand side of the frame causing a serious accident.

Removal

1. Place the bike on the centerstand and remove the seat.
2. Remove the mufflers as described under *Exhaust System Removal/Installation* in the Chapter Six section of this supplement.
3. Remove the rear wheel as described in Chapter Ten in the main body of this book.

NOTE

On 1982-on Interstate models, remove the rear wheel as described in this section of the supplement.

4. Remove the lower mounting nut and washer securing each shock absorber.

NOTE

It is not necessary to remove the shock absorber units.

5. Remove the final drive unit as described in this section of the supplement.
6. Remove the bolt securing the rear brake caliper and torque link to the rear swing arm. Disconnect the hydraulic brake line from the swing arm. Tie the caliper assembly up to the frame with wire or a Bungee cord.
7. Grasp the rear end of the swing arm and try to move it from side to side in a horizontal arc. There should be no noticeable side play. If play is evident and if the pivot adjusting bolt is tightened correctly, the bearings should be replaced.
8. Remove the left-hand pivot cap.
9. Use special tool, Swing Arm Pivot Locknut Wrench (Honda part No. 07908-4690001), and loosen the locknut on the left-hand side.
10. Use an Allen wrench and remove the left-hand adjusting bolt.
11. Move the coil spring off of the rubber boot and slide the rubber boot back onto the swing arm.
12. Remove the right-hand pivot cap.
13. Remove the right-hand pivot bolt.
14. Pull back on the swing arm, free it from the frame and remove it from the frame.

Disassembly/Inspection/Assembly

Refer to **Figure 162** for this procedure.

1. Straighten the tab on the lockwasher. Remove the bolt and remove the brake torque link from the swing arm. Don't lose the collar in the torque link bolt hole.
2. Remove the circlip securing the drive shaft joint and remove the drive shaft joint from the swing arm.
3. Withdraw the drive shaft out through the front portion of the swing arm.
4. Remove the dust seal and roller bearing assembly from each side of the swing arm.
5. The roller bearings wear very slowly and the wear is difficult to measure. Wipe off the excess grease and turn the bearing by hand;

make sure they rotate smoothly. Check the rollers for evidence of wear, pitting or color change (bluish tint) indicating heat from lack of lubrication.

NOTE

Always replace both bearings even though only one may be worn.

6. If the bearing outer races need replacing, refer to *Rear Swing Arm Bearing Replacement* in this section of the supplement.
7. Prior to installing the bearings, coat them with a good grade multipurpose grease. Thoroughly work grease into the roller bearings on both sides of the rear swing arm.

162

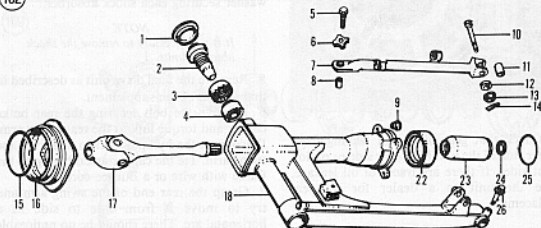

REAR SWING ARM ASSEMBLY

- | | |
|----------------------|----------------------------|
| 1. Pivot cap | 15. Coil spring |
| 2. Pivot bolt | 16. Rubber boot |
| 3. Dust seal | 17. Drive shaft |
| 4. Bearing | 18. Rear swing arm |
| 5. Bolt | 19. Grease seal |
| 6. Lockwasher | 20. Pivot adjusting collar |
| 7. Brake torque link | 21. Locknut |
| 8. Collar | 22. Oil seal |
| 9. Hex nut | 23. Drive shaft joint |
| 10. Bolt | 24. Circlip |
| 11. Collar | 25. O-ring |
| 12. Washer | 26. Axle pinch bolt |
| 13. Nut | |
| 14. Cotter pin | |

8. Apply a light coat of grease to the dust seal and install one on each side.
9. Apply a coat of molybdenum disulfide grease (NLGI No. 2) to the outer splines of the drive shaft and the inner splines of the drive shaft joint. Also apply a light coat of this grease to the lips of the dust seal at the rear of the swing arm where the drive shaft joint rides.
10. Install the drive shaft and drive shaft joint. Install a new circlip and make sure the circlip is properly seated in the groove in the drive shaft.
11. Install a new lockwasher and install the brake torque link, collar and bolt. Tighten the bolt to 16 ft.-lb. (2.1 mkg). Bend up at least one side of the lockwasher onto the flats of the bolt.

Installation

1. Position the swing arm into the mounting area of the frame. Align the holes in the swing arm with the holes in the frame. Carefully align the drive shaft universal joint splines to the engine.

NOTE

Within the area of the rubber boot, align the universal joint and have a helper push the drive shaft forward from the rear.

2. On the right-hand side, apply a light coat of grease to the inner end of the right-hand pivot bolt. Install the right-hand pivot bolt.
3. Make sure the rear swing arm is properly located in the frame and then tighten the right-hand pivot bolt to 72 ft.-lb. (10.0 mkg).
4. Apply a light coat of grease to the inner end of the pivot adjusting bolt. Install the pivot adjusting bolt and tighten to 13 ft.-lb. (1.0 mkg).
5. Move the swing arm up and down several times to make sure all components are properly seated.
6. Retighten the pivot adjusting bolt to 13 ft.-lb. (1.0 mkg).
7. Use special tool, Locknut Wrench (used during removal), and tighten the locknut to 72 ft.-lb. (10.0 mkg). Make sure the pivot adjusting bolt does not move while tightening the locknut.

8. Install the final drive unit as described in this section of this supplement.
9. Install the rear wheel as described in Chapter Ten in the main body of this book.

NOTE

On 1982-on Interstate models, install the rear wheel as described in this section of the supplement.

10. Install the mufflers as described under *Exhaust System Removal/Installation* in Chapter Six in the main body of this book.

Swing Arm Bearing Replacement

The swing arm is equipped with a roller bearing at each end. The inner race and roller bearing will come right out (no force needed) after the grease seal is removed. The bearing outer race is pressed in place and has to be removed with force. The race will get distorted when removed, so don't remove it unless it needs replacement.

The bearing outer race can be removed either with a long drift and hammer or with the use of a special tool (Figure 163) that is available from a Honda dealer. The special tool is called a bearing race remover (Honda part No. 07946-3710S00).

1. Remove the swing arm as described in this section of the supplement.
2. Secure the swing arm in a vise with soft jaws.
3. Carefully tap the bearing outer race out with a soft aluminum or brass drift from the opposite end or use the Honda special tool and pull it out. This special tool grabs the outer race and then withdraws it from the swing arm with the use of a tool similar to a body shop slide hammer.
4. Turn the swing arm over in the vise and repeat for the other end.
5. Thoroughly clean out the inside of the swing arm with solvent and dry with compressed air.
6. Apply a light coat of waterproof grease to all parts prior to installation.
7. Tap the new roller bearing outer race into place slowly and squarely with a socket that

163

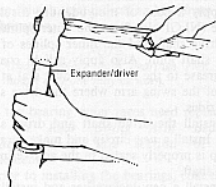
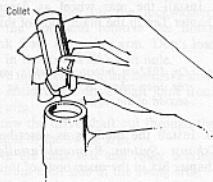

matches the outer diameter of the bearing race. Make sure it is properly seated.

CAUTION

Never reinstall a bearing outer race that has been removed. During removal it becomes slightly damaged and is no

longer true to alignment. If installed, it will damage the roller bearing assembly and create an unsafe riding condition.

8. Install the swing arm as described in this section of the supplement.

CHAPTER ELEVEN

BRAKES

The brake system on the GL1100 consists of a dual disc on the front wheel and a single disc on the rear. The 1980-1981 models have caliper assemblies with a single piston (covered in Chapter Eleven in the main body of this book); all 1982-on caliper assemblies are a dual piston type.

The 1983 models have a unified brake system. The rear brake pedal and master cylinder are hydraulically connected to and control the front right-hand disc and the single rear disc. The braking force is automatically metered apportioned to each wheel by a proportioning valve. The front brake lever controls the left-hand front disc only.

A combination of metal and flexible brake lines are used on the unified system. The brake line diagram is shown in **Figure 164**.

FRONT BRAKE PAD REPLACEMENT

Dual Piston Caliper Models

CAUTION

Watch the pads more closely when the red line approaches the disc. On some pads the red line is very close to the pad's metal backing plate. If pad wear happens to be uneven for some reason the backing plate may come in contact with the disc and cause damage.

CAUTION

On 1983 models, when installing Honda replacement brake pads use only pads that are marked JBCM-GG or A65-FF. Make sure that all front pads have the same marks. Do not mix JBCM-GG and A65-FF marked pads.

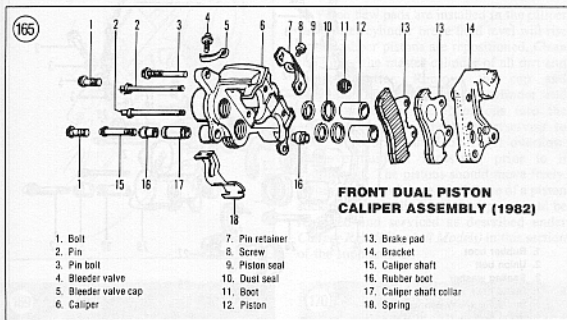
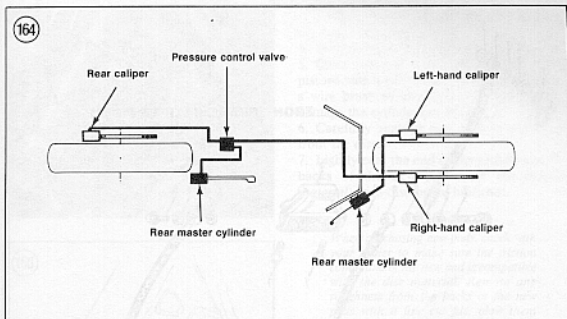

Refer to **Figure 165** for 1982 models or **Figure 166** for 1983 models. This procedure is shown on a 1982 model.

1A. On 1982 models, remove the caliper lower mounting bolt (A, **Figure 167**) and upper pivot bolt (B, **Figure 167**) securing the caliper assembly to the front fork. Remove the caliper assembly from the disc.

1B. On 1983 models, remove the caliper upper pivot bolt (A, **Figure 168**) and lower caliper bolt (B, **Figure 168**) securing the caliper assembly to the front fork. Remove the caliper assembly from the disc.

2. Remove the bolt (**Figure 169**) securing the pin retainer to the caliper assembly and remove the pin retainer.

FRONT BRAKE CALIPER (1983)

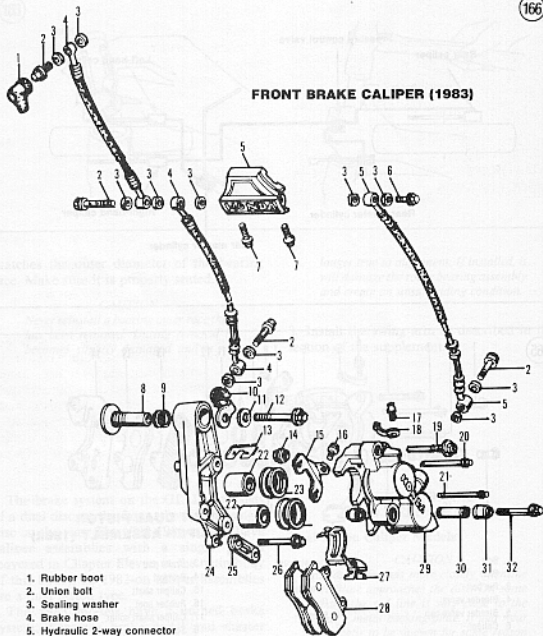

1. Rubber boot
2. Union bolt
3. Sealing washer
4. Brake hose
5. Hydraulic 2-way connector
6. Union bolt
7. Bolt
8. Sleeve
9. O-ring seals
10. Wire clamp
11. Washer
12. Bolt
13. Bracket retainer
14. Boot
15. Pad pin retainer
16. Bolt

17. Bleed valve
18. Cap
19. Pivot bolt
20. Pad pin
21. Pad pin
22. Piston
23. Dust seal/piston seal
24. Caliper bracket

25. Bridge
26. Bolt
27. Anti-rattle spring
28. Brake pads
29. Caliper body
30. Sleeve
31. Pin boot
32. Caliper bolt

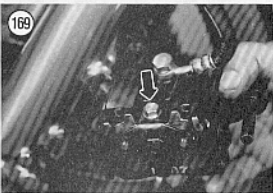
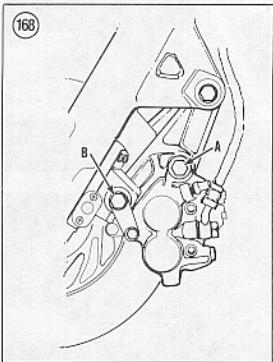
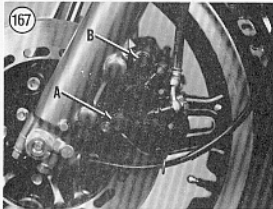

3. Remove the 2 pins (Figure 170) securing the pads in place.
4. Remove the brake pads.
5. Clean the pad recess and the end of the pistons with a soft brush. Do not use solvent, a wire brush or any hard tool which would damage the cylinders or pistons.
6. Carefully remove any rust or corrosion from the disc.
7. Lightly coat the end of the pistons and the backs of the new pads (*not the friction material*) with disc brake lubricant.

NOTE

When purchasing new pads, check with your dealer to make sure the friction compound of the new pad is compatible with the disc material. Remove any roughness from the backs of the new pads with a fine cut file; blow them clean with compressed air.

8. When new pads are installed in the caliper the master cylinder brake fluid level will rise as the caliper pistons are repositioned. Clean the top of the master cylinder of all dirt and foreign matter. Remove the cap and diaphragm from the master cylinder and slowly push the caliper pistons into the caliper. Constantly check the reservoir to make sure brake fluid does not overflow. Remove fluid, if necessary, prior to it overflowing. The pistons should move freely. If they don't, and there is evidence of a piston sticking in the cylinder, the caliper should be removed and serviced as described under *Caliper Rebuilding (All Models)* in this section of the supplement.



9. Push the caliper pistons all the way in to allow room for the new pads.

10. Install the anti-rattle spring as shown in Figure 171.

11. Partially install both pins through the outside of the caliper and install the outboard pad (Figure 172). Push the pins through this pad.

12. Install the inboard pad (Figure 173) and push the pins all the way through.

13. Install the pad pin retainer onto the ends of the pins. Push the pin retainer down and make sure it seats completely on the groove in each pin (Figure 174).

14. Install the pad pin retaining bolt (Figure 169).

15. Carefully install the caliper assembly onto the disc. Be careful not to damage the leading edge of the pads during installation.

16. Lubricate the caliper upper pivot bolt with silicone grease.

17A. On 1982 models, install the caliper lower mounting bolt (A, Figure 167) and upper pivot bolt (B, Figure 167). Tighten the pivot bolt to 18-22 ft.-lb. (2.5-3.0 mkg) and the lower mounting bolt to 14-18 ft.-lb. (2.0-2.5 mkg).

17B. On 1983 models, install the caliper upper pivot bolt (A, Figure 168) and lower caliper bolt (B, Figure 168). Tighten the caliper upper pivot bolt to 20 ft.-lb. (2.7 mkg) and the lower caliper bolt to 17 ft.-lb. (2.3 mkg).

18. Repeat for the other caliper assembly.

19. Place wood blocks under the engine or frame so that the front wheel is off the ground. Spin the front wheel and activate the brake lever as many times as it takes to refill the cylinder in the caliper and correctly locate the pads.

20. Refill the master cylinder reservoir, if necessary, to maintain the correct fluid level. Install the diaphragm and top cap.

WARNING

Use brake fluid clearly marked DOT 3 from a sealed container. Other types may vaporize and cause brake failure. Always use the same brand name; do not intermix as many brands are not compatible.

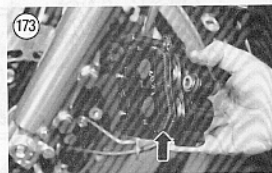
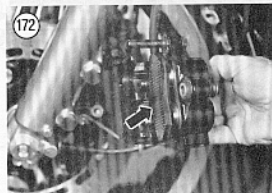
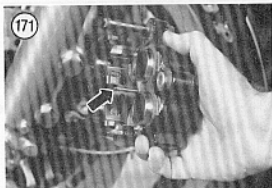

WARNING

Do not ride the motorcycle until you are sure the brake is operating correctly with full hydraulic advantage. If necessary, bleed the brake as described in Chapter Three in the main body of this book or in this section of the supplement.

21. Bed the pads in gradually for the first 50 miles (80 km) by using only light pressure as much as possible. Immediate hard application will glaze the new friction pads and greatly reduce the effectiveness of the brake.

FRONT CALIPERS**Removal/Installation****(Dual Piston Caliper Models)**

Refer to Figure 165 for 1982 models or Figure 166 for 1983 models. This procedure is shown on a 1982 model.

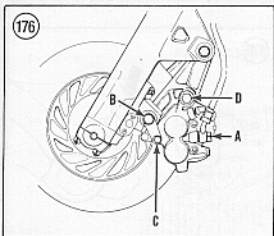
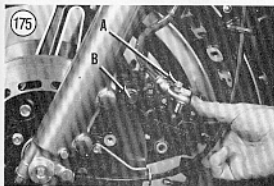

It is not necessary to remove the front wheel in order to remove either or both caliper assemblies.

CAUTION

Do not spill any brake fluid on the painted portion of the wheel. Wash off any spilled brake fluid immediately, as it will destroy the finish. Use soapy water and rinse completely.

- 1A. On 1982 models perform the following:
 - a. Place a container under the brake line at the caliper.
 - b. Remove the union bolt and sealing washers (A, Figure 175) securing the brake line to the caliper assembly.
 - c. Remove the brake line and let the brake fluid drain out into the container. Dispose of this brake fluid—never reuse brake fluid.
 - d. To prevent the entry of moisture and dirt, cap the end of the brake line and tie the loose end up to the forks.
 - e. Loosen the caliper upper pivot bolt and caliper lower mounting bolt gradually in several steps. Push on the caliper while loosening the bolts to push the pistons back into the caliper.
 - f. Remove the caliper mounting bolt and caliper pivot bolt (B, Figure 167) and remove the caliper assembly.
- 1B. On 1983 models perform the following:
 - a. Place a container under the brake line at the caliper.
 - b. Remove the union bolt and sealing washers (A, Figure 176) securing the brake line to the caliper assembly.
 - c. Remove the brake line and let the brake fluid drain out into the container. Dispose of this brake fluid—never reuse brake fluid.
 - d. To prevent the entry of moisture and dirt, cap the end of the brake line and tie the loose end up to the forks.
 - e. Loosen the caliper lower mounting bolt (B, Figure 176) slowly in several steps. Push on the caliper while loosening the bolt to push the pistons back into the caliper.

- f. Remove the caliper bolt (C, **Figure 176**) and move the caliper bridge forward and out of the way.
 - g. Remove the caliper pivot bolt (D, **Figure 176**) and remove the caliper assembly from the disc.
2. Repeat Step 1 for the other caliper assembly.
 3. Lubricate the caliper pivot bolt with silicone grease.
 4. Install by reversing these removal steps, noting the following.
 5. Carefully install the caliper assemblies onto the disc. Be careful not to damage the leading edge of the pads during installation.
 - 6A. On 1982 models, tighten the bolts to the following torque specifications:
 - a. Caliper pivot bolt: 18-22 ft.-lb. (2.5-3.0 mkg).
 - b. Lower mounting bolt: 14-18 ft.-lb. (2.0-2.5 mkg).
 - 6B. On 1983 models, tighten the bolts to the following torque specifications:
 - a. Caliper pivot bolt: 20 ft.-lb. (2.7 mkg).
 - b. Lower mounting bolt: 17 ft.-lb. (2.3 mkg).
 - c. Caliper bolt: 17 ft.-lb. (2.3 mkg).
 7. Install the brake hose, with a sealing washer on each side of the fitting, onto the caliper. Install the union bolt and tighten to 22 ft.-lb. (3.0 mkg).
 8. Bleed the brake as described in Chapter Three in the main body of this book (1982 models) or as described in this section of the supplement (1983 models).

WARNING

Do not ride the motorcycle until you are sure that the brakes are operating properly.

REAR MASTER CYLINDER

Removal/Installation

Refer to **Figure 177** for this procedure.

1. Remove the right-hand side cover.
2. Remove the cotter pin and pivot pin from the rod eye at the bottom of the master cylinder where it attaches to the brake pedal.

CAUTION

Cover the surrounding frame with a heavy cloth or plastic tarp to protect it

from accidental spilling of brake fluid. Wash any brake fluid off of any painted or plated surfaces immediately, as it will destroy the finish. Use soapy water and rinse completely.

3. Place a container under the brake hose where it attaches to the master cylinder.
- 4A. On 1982 models, remove the union bolt (A, **Figure 178**) securing the brake hose to the rear of the master cylinder.
- 4B. On 1983 models, remove the nut (**Figure 179**) securing the metal brake line to the rear of the master cylinder.

NOTE

Drain the brake fluid from the hose or line and discard it—never reuse brake fluid. Contaminated brake fluid may cause brake failure.

5. Remove the flange bolt (**Figure 180**) securing the reservoir to the frame.
6. Remove the bolts (B, **Figure 178**) securing the master cylinder to the frame.

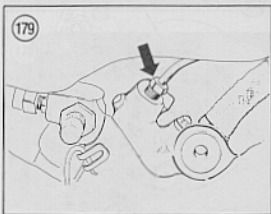
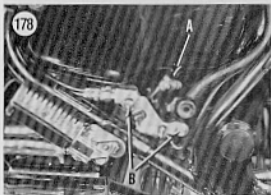

177

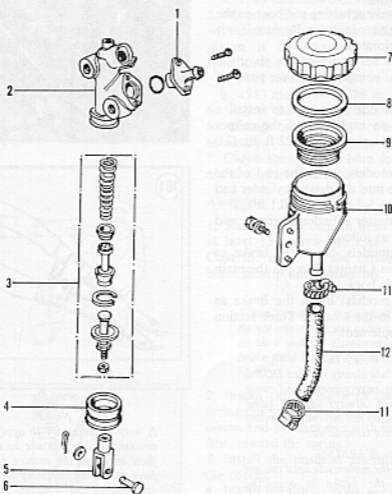

REAR MASTER CYLINDER ASSEMBLY

- | | |
|---------------------------|--------------------|
| 1. Reservoir hose fitting | 7. Reservoir cap |
| 2. Master cylinder body | 8. Gasket |
| 3. Piston assembly | 9. Diaphragm |
| 4. Rubber boot | 10. Reservoir |
| 5. Red eye | 11. Hose clamp |
| 6. Pin | 12. Reservoir hose |

7. Remove the reservoir, interconnecting brake hose and the master cylinder.
8. Install by reversing these removal steps, noting the following.
9. Inspect the brake actuating rod boot on the bottom of the master cylinder. Replace if it is cracked or deteriorated.
10. Install a new cotter pin on the pivot pin and bend it over completely. Never reuse an old cotter pin.
- 11A. On 1982 models, be sure to install a sealing washer on each side of the caliper hose. Tighten the union bolt to 22 ft.-lb. (3.0 mkg).
- 11B. On 1983 models, insert the end of the metal brake line into the master cylinder and tighten the nut to 5-7 ft.-lb. (0.7-0.1 mkg).
12. Refill the master cylinder reservoir and bleed the brake as follows:
 - a. On 1982 models, bleed the brake as described in Chapter Three in the main body of this book.
 - b. On 1983 models, bleed the brake as described in the Chapter Three section of this supplement.

WARNING

Use brake fluid clearly marked DOT 3 only. Others may vaporize and cause brake failure. Always use the same brand name; do not intermix, as many brands are not compatible.

WARNING

Do not ride the motorcycle until you are sure that the brake is operating correctly with full hydraulic advantage.

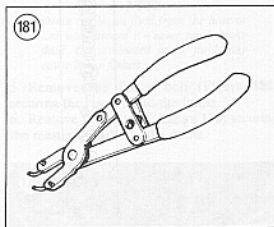
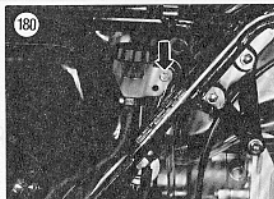
**NOTE**

It may be necessary to apply a small amount of air pressure to the brake fluid outlet of the master cylinder to force the piston assembly and primary cup out of the bore in the master cylinder.

Disassembly

Refer to **Figure 177** for this procedure.

1. Remove the master cylinder as described in this section of the supplement.
2. Loosen the hose clamp and remove the brake hose from the master cylinder. Remove the brake hose and the reservoir from the master cylinder.
3. Remove the rod eye and the rubber boot.
4. Using circlip pliers (**Figure 181**) remove the circlip and pull the pushrod assembly out of the master cylinder body.
5. Remove the piston assembly, primary cup and spring.

Inspection

1. Clean all parts in denatured alcohol or fresh brake fluid. Inspect the cylinder bore and piston contact surfaces for signs of wear and damage. If either part is less than perfect, replace it.
2. Check the end of the piston for wear caused by the pushrod.
3. Make sure the passages in the bottom of the brake fluid reservoir are clear. Check the reservoir cap and diaphragm for damage and deterioration and replace as necessary.
4. Measure the cylinder bore with a cylinder gauge (**Figure 182**). Replace the master

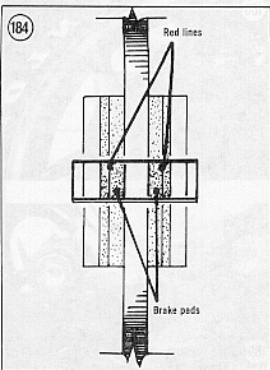
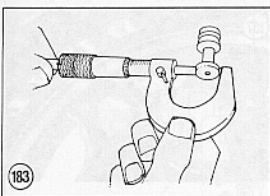
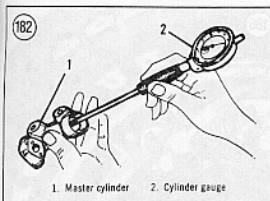

cylinder if it is worn to the following specification or more:

- a. 1982 models—0.5533 in. (14.055 mm).
- b. 1983 models—0.6270 in. (15.925 mm).

5. Measure the outside diameter of the piston with a micrometer (Figure 183). Replace the piston if it is worn to the following specification or less:

- a. 1982 models—0.5488 in. (13.940 mm).
- b. 1983 models—0.6226 in. (15.815 mm).

6. Inspect the primary and secondary cups for damage or wear. Replace as necessary.

7. Check the cylinder bore for scratches or nicks. Replace if necessary.

Assembly

1. Soak the new cups in fresh brake fluid for at least 15 minutes to make them pliable. Coat the inside of the cylinder with fresh brake fluid prior to assembly.

CAUTION

When installing the piston assembly, do not allow the cups to turn inside out as they will be damaged and allow brake fluid leakage within the cylinder bore.

2. Install the spring with the tapered end facing out toward the primary cup. Install the piston and primary cup with the open end in first, toward the spring.

3. Install the pushrod assembly and install the circlip.

4. Install the rubber boot, nut and rod eye.

5. Install the master cylinder as described in this section of the supplement.

REAR BRAKE PAD REPLACEMENT

There is no recommended mileage interval for changing the friction pads in the disc brake. Pad wear depends greatly on riding habits and conditions. To maintain even pressure on the disc always replace both pads at the same time.

CAUTION

Watch the pads more closely when the red line approaches the disc (Figure 184). On some pads the red line is very

close to the pad's metal backing plate. If pad wear happens to be uneven for some reason the backing plate may come in contact with the disc and cause damage.

Single Piston Caliper Models

Refer to **Figure 185** for this procedure.

1. Remove the bolts (**Figure 186**) securing the caliper and remove it. Remove both pads and the shim.

NOTE

Tie the caliper assembly up to the rear grab bar with a piece of wire or Bungee cord.

2. Clean the pad recesses and the ends of the pistons with a soft brush. Don't use solvent, a wire brush or any hard tool which would damage the cylinders or pistons.
3. Lightly coat the ends of the pistons and the backs of the new pads (not the friction material) with disc brake lubricant.

NOTE

Check with your dealer to make sure the friction compound of the new pad is compatible with the disc material. Remove any roughness from the metal backs of the pads with a fine file and blow them clean with compressed air.

4. Remove the cap from the master cylinder reservoir and slowly push the piston into the caliper while checking the reservoir to make sure the fluid does not overflow. The piston should move freely. If it does not move freely and there is any evidence of it sticking in the cylinder, the caliper should be removed and serviced as described under *Caliper Rebuilding* in this section of the supplement.
5. Push the caliper piston into the caliper to allow room for the new pads to be installed.
6. Install the inboard pad (**Figure 187**).
7. Install the outboard pad and anti-rattle shim. Place the shim next to the piston (**Figure 188**) with the arrow (**Figure 189**) facing in the direction of normal wheel rotation.
8. Make sure the brake pad spring (**Figure 190**) is in place in the caliper.

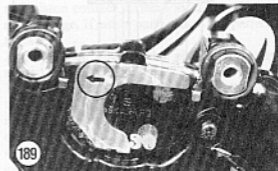
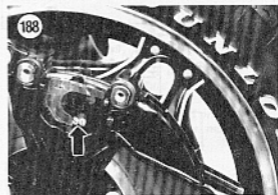

185

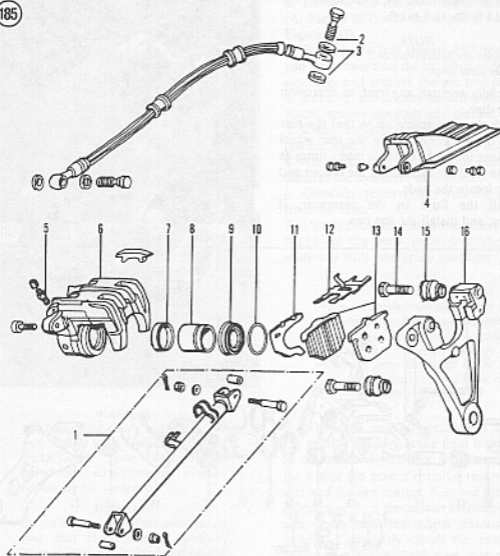

REAR SINGLE-PISTON CALIPER ASSEMBLY

- | | |
|-------------------------|----------------------|
| 1. Torque link assembly | 9. Dust cover |
| 2. Union bolt | 10. O-ring |
| 3. Sealing washer | 11. Shim |
| 4. Dust cover | 12. Brake pad spring |
| 5. Bleeder valve | 13. Brake pads |
| 6. Caliper | 14. Caliper pins (2) |
| 7. Seal | 15. Dust covers (2) |
| 8. Caliper piston | 16. Caliper bracket |

9. Install the caliper and the bolts; tighten the bolts to 13 ft.-lb. (1.8 mkg).

NOTE

Tighten the bolts evenly in 2 or 3 steps to the final torque.

10. Carefully remove any rust or corrosion from the disc.
 11. Block the motorcycle up so that the rear wheel is off the ground. Spin the rear wheel and activate the brake pedal as many times as it takes to refill the cylinder in the caliper and correctly locate the pads.
 12. Refill the fluid in the reservoir, if necessary, and install the top cap.



191

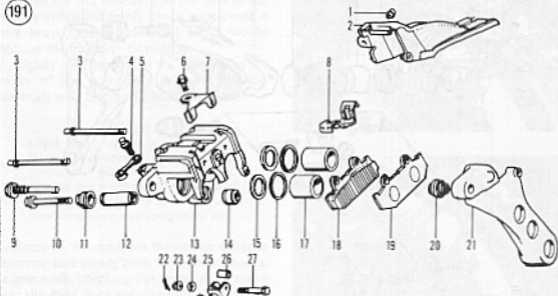

REAR DUAL PISTON CALIPER ASSEMBLY

- | | |
|--------------------------|-----------------|
| 1. Screw | 15. Piston seal |
| 2. Dust cover | 16. Dust seal |
| 3. Pin | 17. Piston |
| 4. Bleeder valve | 18. Brake pad |
| 5. Bleeder valve cap | 19. Brake pad |
| 6. Screw | 20. Boot |
| 7. Pin retainer | 21. Bracket |
| 8. Spring | 22. Cotter pin |
| 9. Pin bolt | 23. Nut |
| 10. Caliper shaft | 24. Washer |
| 11. Rubber boot | 25. Torque link |
| 12. Caliper shaft collar | 26. Collar |
| 13. Caliper | 27. Bolt |
| 14. Rubber boot | |

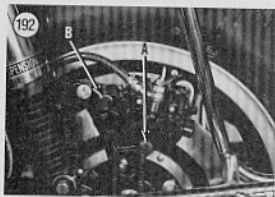
**WARNING**

Use brake fluid clearly marked DOT 3 only. Others may vaporize and cause brake failure. Always use the same brand name; do not intermix, as many brands are not compatible.

WARNING

Do not ride the motorcycle until you are sure that the brake is operating correctly with full hydraulic advantage. If necessary, bleed the brakes as described under **Brake Bleeding** in Chapter Three in the main body of this book.

13. Bed the pads in gradually for the first 50 miles (80 km) by using only light pressure as much as possible. Immediate hard application will glaze the new friction pads and greatly reduce the effectiveness of the brake.

Dual Piston Caliper Models

Refer to Figure 191 for this procedure.

1. Remove the screw securing the dust cover and remove the dust cover.

2. Remove the caliper lower mounting bolt (A, Figure 192) and the upper pivot bolt (B, Figure 192).

3. Remove the bolt (Figure 193) securing the pad pin retainer on the backside of the caliper assembly and remove the pin retainer.

4. Remove the 2 pins securing the pads in place, remove the pads and discard them.

5. Clean the pad recess and the end of the pistons with a soft brush. Do not use solvent, a wire brush or any hard tool which would damage the cylinders or pistons.

6. Carefully remove any rust or corrosion from the disc.

7. Lightly coat the end of the pistons and the backs of the new pads (*not the friction material*) with disc brake lubricant.

NOTE

When purchasing new pads, check with your dealer to make sure the friction compound of the new pad is compatible with the disc material. Remove any roughness from the backs of the new pads with a fine-cut file; blow them clean with compressed air.

8. When new pads are installed in the caliper the master cylinder brake fluid level will rise as the caliper pistons are repositioned. Clean the top of the master cylinder reservoir of all dirt and foreign matter. Remove the cap and diaphragm from the master cylinder reservoir and slowly push the caliper pistons into the caliper. Constantly check the reservoir to make sure brake fluid does not overflow. Remove fluid, if necessary, prior to it overflowing. The pistons should move freely. If they don't, and there is evidence of a piston sticking in the cylinder, the caliper should be removed and serviced as described under *Caliper Rebuilding* in this section of the supplement.

9. Push the caliper in toward the disc to allow room for the new pads.

10. Partially install both pins through the caliper.

11. Make sure the anti-rattle spring (A, Figure 194) is installed in the caliper.

12. Install the outboard pad (B, Figure 194) and push the pins through this pad.

13. Install the inboard pad and push the pins in all the way (Figure 195) through both pads.
14. Install the pin retainer on the backside of the caliper, push it down and make sure it is correctly installed into the groove in each pin. Tighten the screw securely.
15. Carefully install the caliper assembly down onto the disc and install the caliper pivot bolt (B, Figure 192) and caliper mounting bolt (A, Figure 192).
16. Tighten the mounting bolt to 14-18 ft.-lb. (2.0-2.5 mkg) and the pivot bolt to 18-22 ft.-lb. (2.5-3.0 mkg).
17. Spin the rear wheel and activate the brake pedal as many times as it takes to refill the cylinder in the caliper and correctly locate the pads.
18. Refill the master cylinder reservoir, if necessary, to maintain the correct fluid level. Install the diaphragm and top cap.

WARNING

Use brake fluid clearly marked DOT 3 from a sealed container. Other types may vaporize and cause brake failure. Always use the same brand name; do not intermix as many brands are not compatible.

WARNING

Do not ride the motorcycle until you are sure the brake is operating correctly with full hydraulic advantage. If necessary, bleed the brake.

19. Bed the pads in gradually for the first 50 miles (80 km) by using only light pressure as much as possible. Immediate hard application will glaze the new friction pads and greatly reduce the effectiveness of the brake.

REAR CALIPER**Removal/Installation
(Single Piston Caliper Models)**

Refer to Figure 185 for this procedure.

1. Place a container under the brake line at the caliper. Remove the union bolt and sealing washers securing the brake line to the caliper assembly. Remove the brake line and let the brake fluid drain out into the container. To prevent the entry of moisture

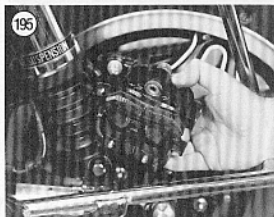
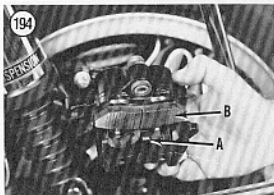

and dirt, cap the end of the brake line and tie the loose end up to the grab bar.

WARNING

Dispose of this brake fluid—never reuse brake fluid. Contaminated brake fluid can cause brake failure.

2. Remove the caliper mounting bolts (Figure 186) and push on the caliper to push the piston back into the caliper. Remove the caliper.
3. Remove the 2 brake pads and shim.
4. Remove the cotter pin and the bolt securing the caliper bracket to the torque link.
5. Remove the rear wheel as described in Chapter Ten in the main body of this book.

NOTE

On 1982-on Interstate models, remove the rear wheel as described in the Chapter Ten section of this supplement.

6. Remove the caliper bracket.

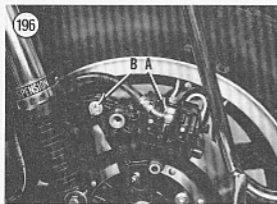

7. Install by reversing these removal steps, noting the following steps.
8. Carefully install the caliper assembly onto the disc. Be careful not to damage the leading edge of the pads during installation.
9. Tighten the torque link bolt and nut to 16 ft.-lb. (2.1 mkg). Install a new cotter pin and bend it over completely. Never reuse an old cotter pin. Tighten the caliper mounting bolts to 13 ft.-lb. (1.8 mkg).
10. Install the brake hose onto the caliper. Be sure to place a sealing washer on each side of the fitting and install the union bolt. Tighten the union bolt to 22 ft.-lb. (3.0 mkg).
11. Bleed the brake as described in Chapter Three in the main body of this book (1982 models) or in the Chapter Three section of this supplement (1983 models).

WARNING

Do not ride the motorcycle until you are sure that the brakes are operating properly.

Removal/Installation (Dual Piston Caliper Models)

Refer to Figure 191 for this procedure.

CAUTION

Do not spill any brake fluid on the painted portion of the wheel or the painted fork slider. Wash any spilled brake fluid immediately, as it will destroy the finish. Use soapy water and rinse completely.

1. Remove the caliper mounting and pivot bolts.
2. Place a container under the brake line at the caliper. Remove the union bolt and sealing washers (A, Figure 196) securing the brake line to the caliper assembly. Remove the brake line and let the brake fluid drain out into the container. Dispose of this brake fluid—never reuse brake fluid. To prevent the entry of moisture and dirt, cap the end of the brake line and tie the loose end up to the grab bar.
3. Remove the cotter pin and the bolt (B, Figure 196) securing the caliper bracket to the torque link. Remove the caliper assembly.
4. Install by reversing these removal steps, noting the following.
5. Carefully install the caliper assembly onto the disc. Be careful not to damage the leading edge of the pads during installation.
6. Tighten the torque link bolt and nut to 16 ft.-lb. (2.0 mkg). Install a new cotter pin and bend it over completely. Never reuse an old cotter pin. Tighten the caliper mounting bolt to 14-18 ft.-lb. (2.0-2.5 mkg) and the caliper pivot bolt to 18-22 ft.-lb. (2.5-3.0 mkg).
7. Install the brake hose onto the caliper. Be sure to place a sealing washer on each side of the fitting and install the union bolt. Tighten the bolt to 21 ft.-lb. (3.0 mkg).
8. Bleed the brake as described under *Brake Bleeding* in Chapter Three in the main body of this book.

WARNING

Do not ride the motorcycle until you are sure that the brakes are operating properly.

Caliper Rebuilding (All Models)

If the caliper leaks, the caliper should be rebuilt. If the pistons stick in the cylinders, indicating severe wear or galling, the entire unit should be replaced. Rebuilding a leaky caliper requires special tools and experience.

Caliper service should be entrusted to a dealer, motorcycle repair shop or brake specialist. Considerable money can be saved by removing the caliper yourself and taking it in for repair.

METAL BRAKE LINE REPLACEMENT (1983)

A combination of metal and flexible brake lines are used on the unified system. Refer to **Figure 197** for this procedure.

1. Place the bike on the centerstand.
2. Remove the seat and the top storage compartment.
3. Remove the fuel tank as described in Chapter Six in the main body of this book.
4. Remove both side covers.

CAUTION

Cover the front wheel and the surrounding frame areas with a heavy cloth or plastic tarp to protect it from accidental spilling of brake fluid. Wash any brake fluid off of any painted or plated surfaces immediately, as it will destroy the finish. Use soapy water and rinse completely.

NOTE

Step 5 is necessary to drain as much brake fluid from the system as possible. That way there will be a minimal amount of fluid spillage on the frame when the metal brake lines are disconnected and removed.

5. At the front right-hand caliper and the rear caliper perform the following:
 - a. Place a container under the brake line at the caliper.

- b. Remove the union bolt and sealing washers (**Figure 198**) securing the flexible brake line to the caliper assembly.
- c. Remove the brake line and let the brake fluid drain out into the container. Slowly depress the brake pedal several times to force out the brake fluid. Dispose of this brake fluid—never reuse brake fluid.

NOTE

Drain the brake fluid from the hose or line and discard it—never reuse brake fluid. Contaminated brake fluid may cause brake failure.

6. Remove the crankcase breather system storage tank (**Figure 199**) from the breather hose.
7. Unscrew the nuts securing all 3 metal lines to the pressure control valve.
8. Unscrew the nut (**Figure 200**) securing metal line "A" to the rear master cylinder.
9. Unscrew the nut (**Figure 201**) securing metal line "B" to the rear brake flexible line.
10. Unscrew the nut (**Figure 202**) securing metal line "C" to the right-hand front brake flexible line.
11. Remove the metal brake lines from any clamps on the frame and remove all metal brake lines.
12. Install by reversing these removal steps, noting the following.

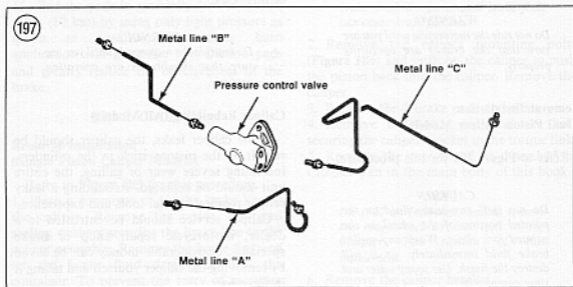

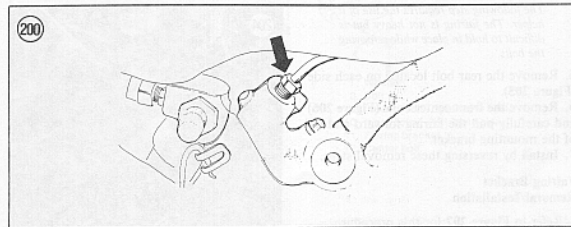
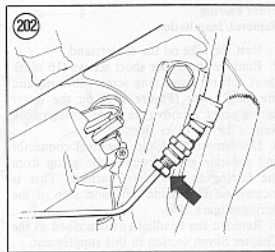
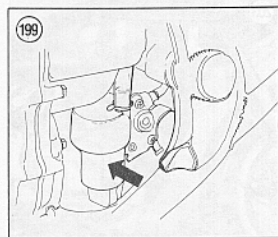
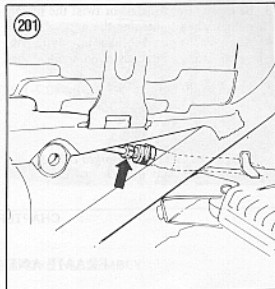
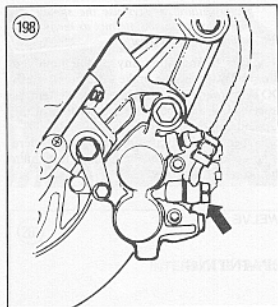

13. Be careful not to bend or twist the metal brake lines when tightening the nuts.
14. Align each metal brake line with its respective fitting and then hand tighten the nuts.
15. Tighten all nuts to 5-7 ft.-lb. (0.7-1.0 mkg).

WARNING

Use brake fluid clearly marked DOT 3 only. Others may vaporize and cause

brake failure. Always use the same brand name; do not intermix as many brands are not compatible.

16. Prior to installing any of the removed components, refill the brake system with fresh DOT 3 brake fluid and bleed the system as described in the Chapter Three section of the supplement.

17. Operate both brakes and make sure there is no leakage at any of the fittings. Retighten the fittings if necessary.

CHAPTER TWELVE

FRAME AND REPAINTING

Front Fairing**Removal/Installation**

1. Rest the bike on the centerstand.
2. Remove the upper short screws (16 mm), short collars, lower long screw (20 mm) and the long collar (Figure 203) on the lower fairing panel. Remove the lower fairing panel. Repeat for the other side.
3. Disconnect the 9-pin electrical connector and separate green ground wire going from the fairing to the main harness. This is located on the inside left-hand side of the fairing (Figure 204).
4. Remove the headlight as described in the Chapter Seven section in this supplement.

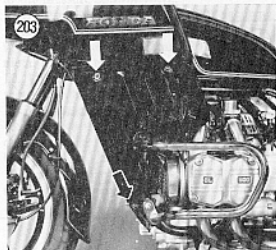
**NOTE**

The following step requires the use of a helper. The fairing is not heavy but is difficult to hold in place while removing the bolts.

5. Remove the rear bolt located on each side (Figure 205).
6. Remove the front center bolts (Figure 206) and carefully pull the fairing forward and off of the mounting bracket.
7. Install by reversing these removal steps.

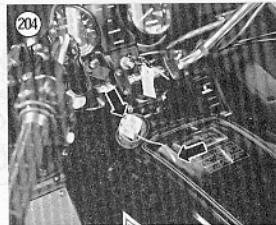
**Fairing Bracket****Removal/Installation**

Refer to Figure 207 for this procedure.

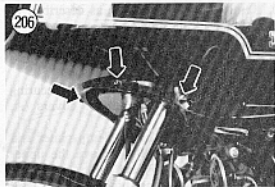
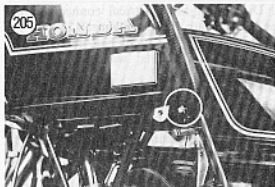

207

INTERSTATE FAIRING BRACKET ASSEMBLY

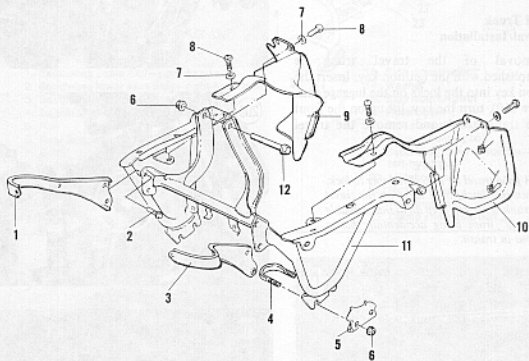

1. Front bracket—right-hand side
2. Bolt
3. Front bracket—left-hand side
4. U-bolt
5. Clamp plate
6. Nut

7. Washer
8. Bolt
9. Inner cover—right-hand side
10. Inner cover—left-hand side
11. Fairing bracket
12. Center bolt

1. Remove the front fairing as described in this section of the supplement.
2. Disconnect the electrical wires to both horns. Remove the bolts and remove both horns.
3. Remove the screws and washers securing the right- and left-hand inner covers (A, Figure 208).
4. Remove the side bolts, clamp plates and clamps (B, Figure 208). Remove the upper center bolt and nut (Figure 209).
5. Carefully slide the bracket down and forward and off of the frame.
6. Install by reversing these removal steps, noting the following.
7. Tighten the upper center bolt and nut to 18 ft.-lb. (2.5 mkg) and the nuts on the clamps to 9 ft.-lb. (1.2 mkg).

4. Disconnect the electrical connectors for the integral turn signals (Figure 212).
5. From inside the saddlebag, remove the lower mounting bolts, washers and nuts (Figure 213).
6. From inside the saddlebag, remove the side mounting bolts (Figure 214) and remove the saddlebag from the bumper assembly.
7. Install by reversing these removal steps, noting the following.

Travel Trunk Removal/Installation

Removal of the travel trunk is accomplished with the ignition key. Insert the ignition key into the locks on the luggage rack (Figure 210), turn the key, lift up on the front of the travel trunk and remove the travel trunk.

NOTE

A good travel tip is to remember to lock, not just latch, both locks on the travel trunk. This will keep all of that valuable "stuff" from being accidentally blown out in transit.

When installing the travel trunk make sure that all of the "feet" on the trunk are positioned securely into the luggage rack. This is necessary so the trunk will not fly off in transit and also for security.

Saddlebag Removal/Installation

Refer to Figure 211 for this procedure.

1. Remove the right- and left-hand side covers and the seat.
2. Remove the travel trunk as described in this section of the supplement.
3. With the ignition key, unlock the lid of the saddlebag and remove the lid.

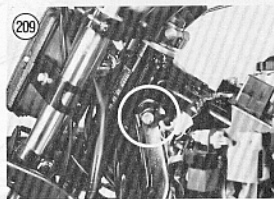
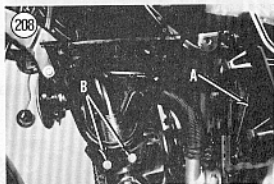

211

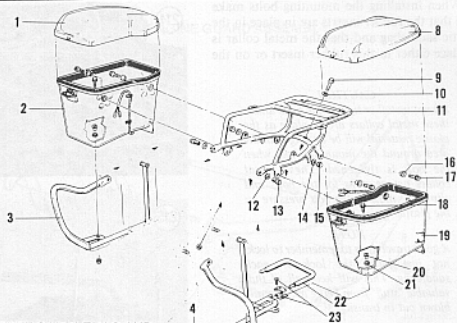

INTERSTATE SADDLEBAG AND BRACKET ASSEMBLY

1. Saddlebag upper (lid) — right-hand side
2. Saddlebag lower assembly — right-hand side
3. Saddlebag bracket — right-hand side
4. Saddlebag bracket — left-hand side
5. Nut
6. Rear foot peg
7. Bolt
8. Saddlebag upper (lid) — left-hand side
9. Rear mounting bolt
10. Washer
11. Luggage rack
12. Washer

13. Side mounting bolt
14. Washer
15. Side mounting nut
16. Metal collar
17. Side mounting bolt
18. Lower mounting bolt
19. Saddlebag lower assembly — left-hand side
20. Metal collar
21. Rubber insert
22. Rear bumper
23. Clamp and clamp bolt

212



213

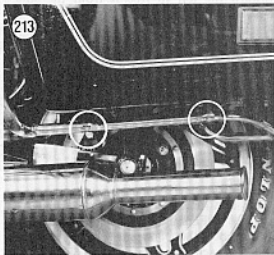

8. When installing the mounting bolts make sure that the rubber inserts are in place in the plastic saddlebag and that the metal collar is in place either in this rubber insert or on the bolt.

CAUTION

Do not install or tighten the bolts unless these metal collars are in place as the plastic material will be damaged in the area around the mounting hole when the bolt is tightened. These metal collars act as stops for the bolts and eliminate most of the bolt pressure on the plastic.

NOTE

A good travel tip is to remember to lock, not just latch, the lock on each saddlebag. This will keep all of that valuable "stuff" from being accidentally blown out in transit.

Luggage Rack Removal/Installation

Refer to Figure 211 for this procedure.

1. Remove the travel trunk and both saddlebags as described in this section of the supplement.
2. Remove the shock absorber upper mounting nut and washer (A, Figure 215).
3. Remove the side mounting bolts (B, Figure 215), side mounting nut (C, Figure 215) and the rear mounting bolt and washer (D, Figure 215).
4. Pull the rear of the luggage rack slightly toward the left to free it from the shock absorber upper mounting stud. Move the luggage rack to the left and free it from the other shock mounting stud and remove the luggage rack.
5. Install by reversing these removal steps, noting the following.
6. Tighten the mounting bolts and nuts to 18 ft.-lb. (2.5 mkg). Tighten the shock absorber mounting nut to 25 ft.-lb. (3.5 mkg).

Bumpers Removal/Installation

Refer to Figure 211 for this procedure.

1. Remove the clamping bolts (A, Figure 216) on each side securing the rear bumper

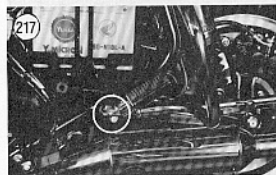
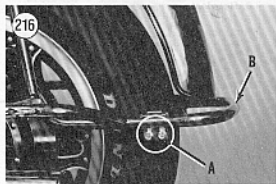
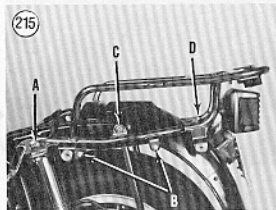
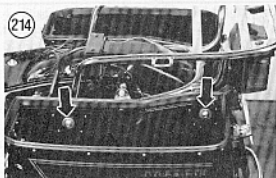

218

INTERSTATE ENGINE GUARD ASSEMBLY

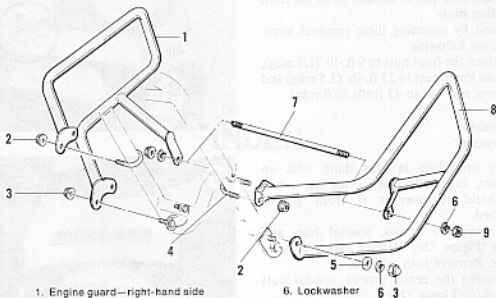

1. Engine guard—right-hand side
2. Upper mounting nut
3. Lower front mounting nut
4. U-bolt
5. Washer

6. Lockwasher
7. Through bolt
8. Engine guard—left-hand side
9. Lower rear mounting nut

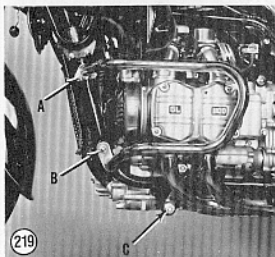

219

(B, Figure 216) and withdraw the rear bumper.

2. Remove the luggage rack as described in this section of the supplement.
3. Remove the bolt securing the rear foot peg (Figure 217).

4. Pull the side bumper straight off of the mounting studs at the top.
5. Repeat Steps 3 and 4 for the other side.
6. Install by reversing these removal steps, noting the following.
7. Tighten the foot peg bolts to 29 ft.-lb. (4.0 mkg) and the rear clamping bolts to 9 ft.-lb. (1.2 mkg).

Engine Guard Removal/Installation

Refer to Figure 218 for this procedure.

1. Remove the upper mounting nuts (A, Figure 219).
2. Remove the lower front mounting nut, lockwasher and washer (B, Figure 219).
3. Remove the lower rear mounting nut and lockwasher (C, Figure 219).

NOTE

The lower rear nuts are attached to a long through bolt. If both engine guards are going to be removed, this bolt can be removed.

- Pull the engine guard slightly up at the rear to clear the rear through bolt and exhaust pipes and then pull it straight off of the front mounting studs.
- Install by reversing these removal steps, noting the following.
- Tighten the front nuts to 9 ft.-lb. (1.2 mkg), the front lower nuts to 25 ft.-lb. (3.5 mkg) and the lower rear nut to 43 ft.-lb. (6.0 mkg).

Windshield Replacement

This procedure is best done with an assistant, especially when installing a new windshield to prevent it from getting scratched.

- Remove the screws, special nuts and collars (Figure 220) securing each rear view mirror. Remove both mirrors.
- Remove the center screws, special nuts and collars (Figure 221).
- Remove the trim panel, windshield and windshield cushion panel.
- Install by reversing these removal steps, noting the following.
- Be sure to install the cushion panel between the fairing surface and the windshield.
- Make sure that the metal collars are used on each hole with each bolt.

CAUTION

Do not install or tighten the bolts unless these metal collars are in place as the windshield will be damaged in the area around the mounting hole when the bolt is tightened. These metal collars act as stops for the bolts and eliminate most of the bolt pressure on the windshield.

- Make sure to position the special nuts with the flat portion facing downward as shown in Figure 222.

Windshield Cleaning

Be careful cleaning the windshield on the 1980 models as it can be easily scratched or damaged. Do not use a cleaner with an abrasive or a combination cleaner and wax. Never use gasoline or cleaning solvent. These

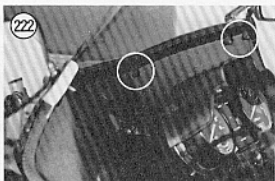
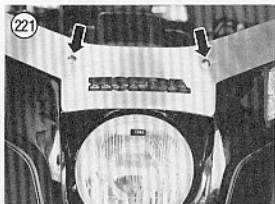

products will either scratch or totally destroy the surface of the windshield.

To remove oil, grease or road tar use isopropyl alcohol, naphtha or kerosene. Then wash the windshield with a solution of mild soap and water. Dry gently with a soft cloth or chamois—do not press hard.

Models since 1981 are equipped with a windshield made of a scratch-resistant polycarbonate plastic. This material is less susceptible to damage and scratching but care must still be taken when cleaning it.

INDEX

A	
Air cleaner	19, 91
Air cut valve	98-99
Air filter	25-27
Alternator	106-107
Alternator drive shaft	63-65
Alternator rotor	63
B	
Battery	20, 105-106
Brakes	
Bleeding	30-31
Caliper, rear	157-161, 262-263
Calipers, front	153-156, 253-254
Disc, front	156-157
Disc, rear	161
Fluid level & changing	25, 30
Lines	22
Master cylinder, front	150-153
Master cylinder, rear	157, 254-257
Metal line brake	264-276
Pad	25, 156, 248-253, 257-262
Troubleshooting	15
1980 & later models	248-266
Breaker points	34-36, 110
C	
Camshaft & rocker mechanism	54-57
Camshaft belt	53-54
Carburetor	39-40, 91-97, 193-206

Centerstand	163
Charging system	12, 103
Clutch	
Adjustment	21
Cable replacement	80
Disassembly & assembly	191-192
Oil pump	51
Removal & installation	80, 83-84, 190-191
Troubleshooting	14
1980 & later models	190-192
Compression test	33-34
Condensers	109-110
Cooling system	29, 117-120
Crankcase	66-71, 188
Crankshaft	76-77
Cylinder heads	57-59, 187

D

Drive shaft	146-147
-------------------	---------

E

Electrical system	
Alternator	106-107
Battery	105-106
Capacitor discharge ignition	209-211
Charging system	103-105
Condensers	109-110
Fuses	116, 220-221

- Horn 115
 Ignition advance mechanism 213-214
 Ignition coils 109, 211-212
 Ignition system 208
 Lighting system 15, 111-115, 214-216
 Pulse generator 212-213
 Rear suspension warning system 216-220
 Rectifier 107-108
 Regulator 108
 Starting system 110-111
 Voltage regulator/rectifier 208
 Wiring diagrams end of book
 1980 & later models 208-221
- Engine**
 Alternator drive shaft 63-65
 Alternator rotor 63
 Camshaft 53-57
 Clutch oil pump 51
 Crankcase 65-71, 188
 Crankshaft 76-77
 Cylinder heads 57-59, 187
 Disassembly & assembly 49
 Final drive shaft 63
 Oil pump 51-52
 Piston rings 76
 Piston & connecting rods 71-75, 188
 Rear cover 62-63
 Removal 42-49
 Troubleshooting 12-13
 Valves & valve seats 59-62, 187
 1980 & later models 187-188
- Exhaust system** 101, 207
- F**
 Fairing 266-268
 Fan 117-118
 Final drive 27, 32, 63, 143-146, 241-243
 Footpegs 163-164
 Fork, front 31, 134-137, 226-234
 Frame 7, 163-165, 266-272
- Fuel system**
 Air cleaner 91
 Air cut valve 98-99
 Carburetors 91-98, 193-206
 Filter changing 30
 Fuel petcock 99-100
 Fuel tank 206-207
 Lines 21
 Troubleshooting 13-14
 1980 & later models 193-207
- Fuses** 116, 220-221
- G**
 General information 1-8, 190
- H**
 Handlebar 129
 Horn 115
 Hubs 25
- I**
 Ignition system, 1975-1979 37-39, 108-109
 Ignition system, 1980 & later 181-182, 208
- K**
 Kickstand (side stand) 169
- L**
 Lighting system 15, 111-115, 214-216
 Lubrication (see Maintenance)
 Lubrication system troubleshooting 13
- M**
Maintenance and lubrication
 (also see Tune-up)
 Air cleaner replacement 29
 Air filter cleaning 21
 Battery 20
 Brakes 23, 27, 30-31
 Clutch adjustment 21-22
 Coolant 19, 29-30
 Cooling system inspection 26
 Engine oil & filter change 23-26
 Engine oil level check 17
 Final drive 27, 32, 243-245
 Fork oil changing 31-32
 Fuel filter change 30
 Fuel lines 27
 General inspection 19
 Intervals 18
 Lubricants & fluids 19
 Nuts, bolts & fasteners 28-29
 Periodic maintenance 177-182
 Routine checks 17-20, 177
 Side stand rubber 27
 Storage 41
 Suspension check 27-28
 Throttle operation 27

- Tire pressures..... 20
- Tire wear..... 22
- Wheel hubs, rims & spokes..... 26-27
- Muffler..... 100

O

- Oil & filter change..... 23-24
- Oil level..... 17
- Oil pumps..... 50-53

P

- Painting..... 164-165
- Parts replacement..... 4
- Piston rings..... 76
- Piston & connecting rods..... 71-75, 188
- Pulse generator..... 212-213

R

- Radiator..... 117
- Rear cover..... 62-63
- Rectifier..... 107-108
- Regulator..... 108
- Rocker mechanism..... 54-57

S

- Saddle bags/scoot boot..... 268
- Safety hints..... 3
- Seat..... 165
- Serial numbers..... 4
- Service hints..... 2-3
- Sidecar
 - Installation..... 166-168
 - Preventive maintenance..... 168
 - Suspension..... 170-173
 - Tires & wheels..... 168-170
- Side stand..... 22, 163
- Spark plugs..... 34
- Spokes..... 125-126, 141
- Starter motor..... 220
- Starter troubleshooting..... 10-12
- Starting system..... 110-111
- Steering..... 15, 129-134, 221
- Storage..... 41
- Suspension, front
 - Anti-dive suspension..... 234-238
 - Check..... 27-28
 - Forks..... 134-137, 226-234
 - Steering head & stem..... 223-226
 - Tires (tubeless)..... 223
 - Troubleshooting..... 15
 - Wheel..... 123-124, 221-223

- 1980 & later models..... 239-248
- Suspension, rear
 - Check..... 28
 - Final drive..... 243-245
 - Shock absorbers..... 141-142, 241-243
 - Swing arm..... 147-149, 245-248
 - Warning system..... 216-220
 - Wheel, rear..... 138-141, 239-241
 - 1980 & later models..... 239-248
- Suspension, with sidecar..... 170-173

T

- Thermostat..... 118
- Throttle operation..... 20-21
- Tires..... 20, 22, 126-129, 223
- Tools..... 4-7
- Troubleshooting
 - Brakes..... 15
 - Charging system..... 12
 - Clutch..... 14
 - Emergency..... 10
 - Engine..... 12-13
 - Front suspension & steering..... 15
 - Fuel system..... 13-14
 - Lighting system..... 15
 - Lubrication troubles..... 13
 - Operation requirements..... 9-10
 - Starter..... 10-12
 - Transmission..... 14, 84-90, 192
- Tune-up
 - Engine (1980 & later)..... 182-185
 - Breaker points..... 34-37
 - Carburetor adjustments..... 39-40
 - Compression test..... 33-34
 - Ignition timing..... 37-39
 - Spark plugs..... 34
 - Specifications..... 37, 180
 - Valve clearance adjustment..... 32-33

V

- Valve clearance adjustment..... 32-33
- Valves & valve seats..... 59-62, 187
- Voltage regulator/rectifier..... 208

W

- Water pump..... 119-120
- Wheel, front..... 121-126, 221-223
- Wheel, rear..... 138-141, 239-241
- Wheel hubs, rims & spokes..... 25
- Wheels with sidecar..... 169-170
- Windshield..... 272
- Wiring diagrams..... end of book

1980-1985 GM 100 Series

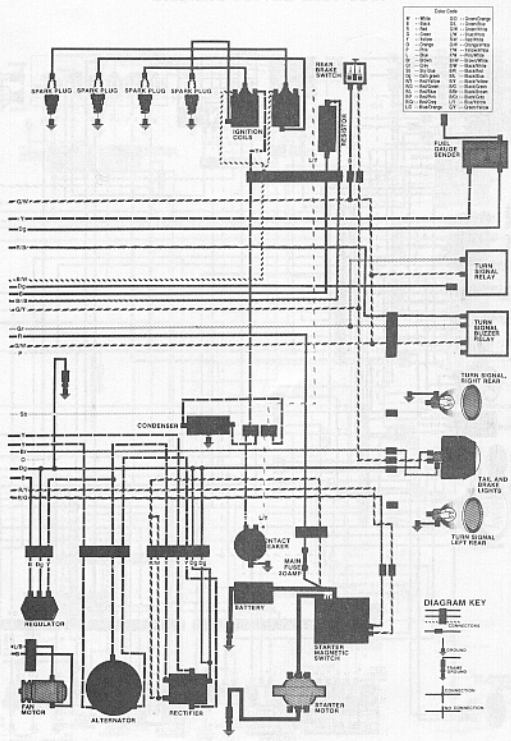

1980-1982 GL1100 Standard

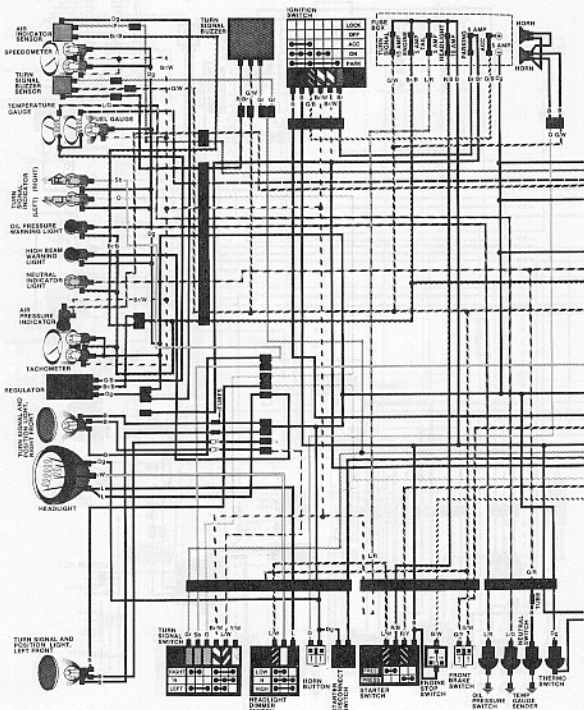

1955-1957 Oldsmobile

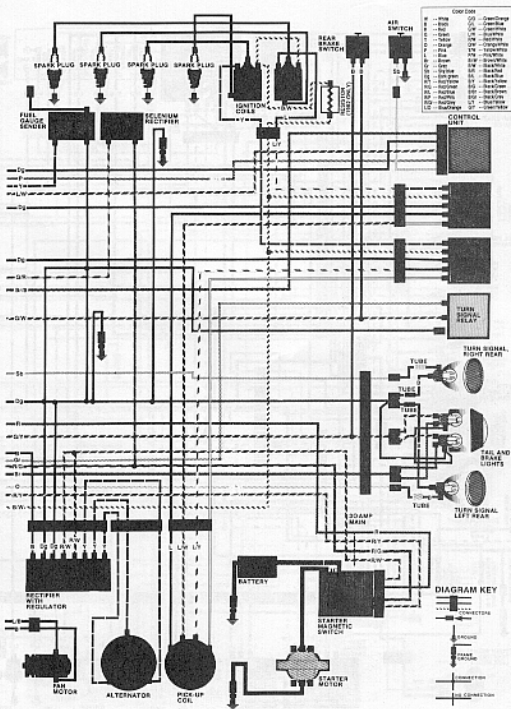

1980-1982 GL1100 Interstate

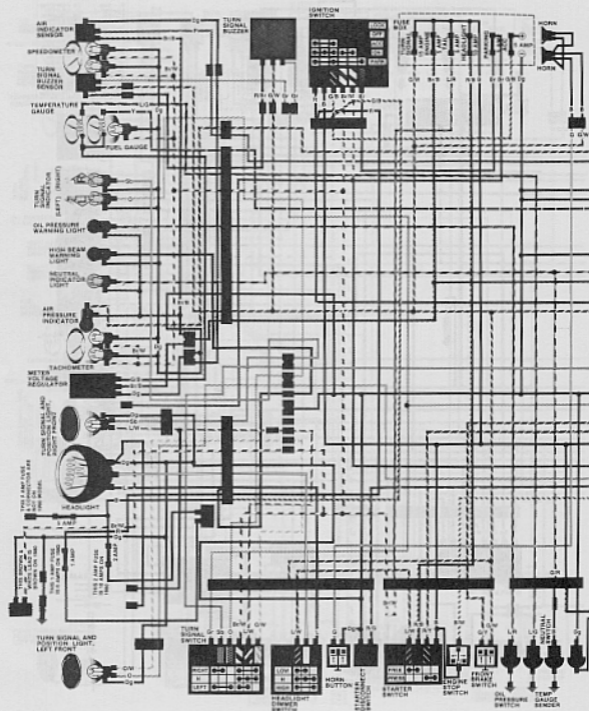

1955 GM 100 Standard

Color Code

W - White	GC - Green/Gray
B - Black	GL - Green/Blue
R - Red	LB - Light Blue
Y - Yellow	LW - Light White
OR - Orange	PF - Purple/Black
L - Blue	BP - Blue/Black
BL - Blue	SL - Silver/Black
GR - Green	SB - Silver/Blue
GY - Gray	SC - Silver/Cyan
CU - Copper	SL - Silver/Black
AV - Red/White	ST - Silver/Tan
AG - Red/Gray	SG - Silver/Gray
AD - Red/Brown	SP - Silver/Black
AP - Red/Pink	ST - Silver/Tan
AS - Red/Black	ST - Silver/Tan

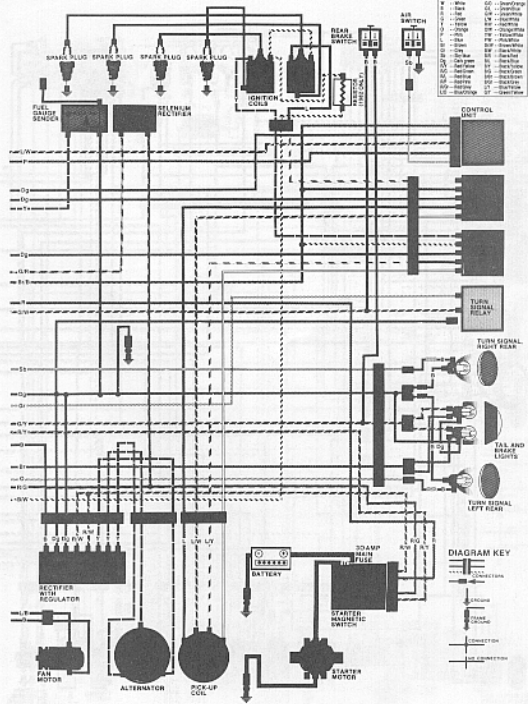
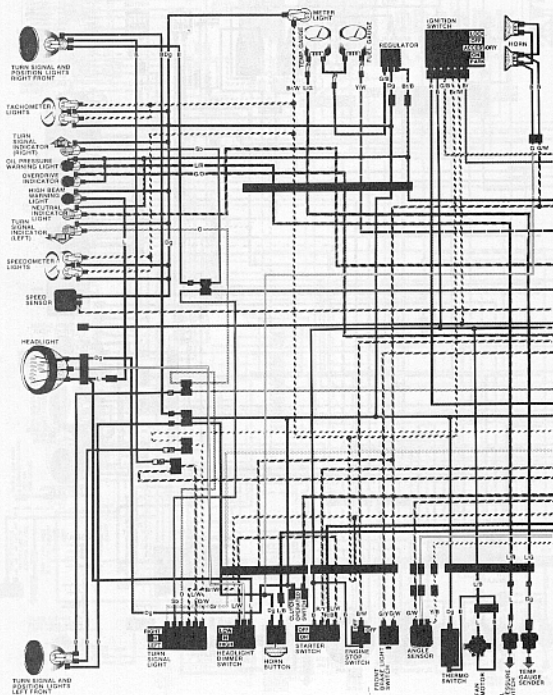

DIAGRAM KEY

- POWER CONNECTION
- - - GROUND CONNECTION
- GROUND CONNECTION
- CONNECTION
- GROUND CONNECTION

1983 GL1100 Standard



1975 Ford Interceptor

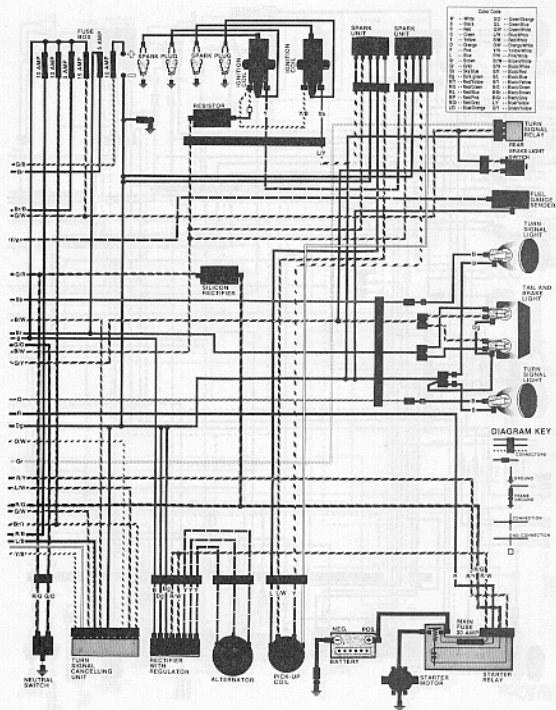

1983 GL1100 Interstate

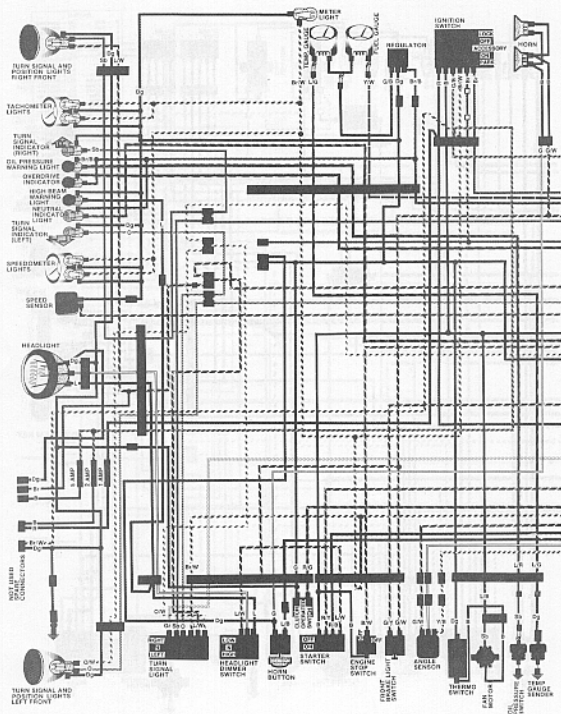

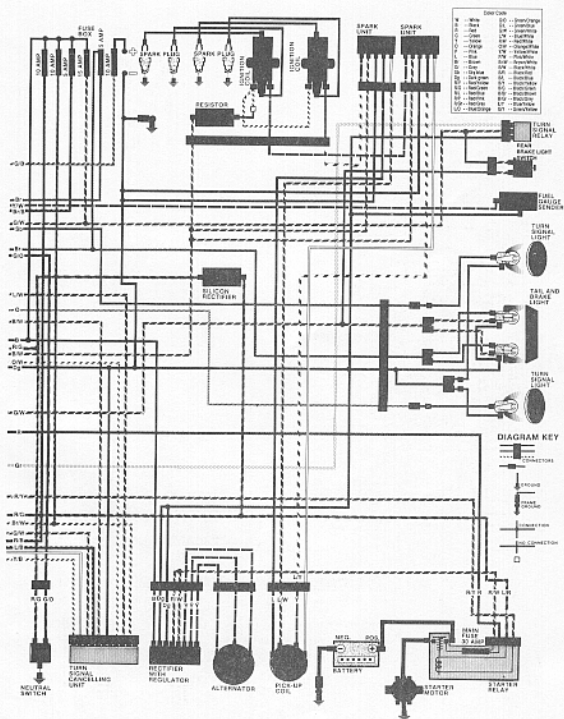

CLYMER[™]
HONDA

GL1000 & 1100 FOURS • 1975-1983
SERVICE • REPAIR • MAINTENANCE

GL1000 (1975-1979) GL1100 (1980-1983) GL1100 Interstate (1980-1983)

This easy-to-use manual can save you money in maintenance and repair bills. Step-by-step procedures and detailed illustrations guide you through every job. Inside, you'll find:

Quick Reference Data

All the most frequently used specifications on specially marked pages.

General Information

Tools, techniques and bike identification.

Troubleshooting

Easy-to-follow text guides you from symptoms to causes.

Periodic Lubrication and Maintenance

All the tasks required for safety and top performance.

Engine

Complete overhaul procedures for 1000 and 1100cc engines.

Clutch and Transmission

Clutch overhaul and cable service; transmission overhaul.

Fuel and Exhaust Systems

Carburetor overhaul/adjustment; fuel delivery system service; exhaust system replacement.

Electrical System

Testing, adjustment and replacement procedures for starting, charging, ignition, lighting and accessory systems.

Cooling System

Service and replacement procedures for radiator, thermostat, water pump and fan.

Front Suspension and Steering

Wheel and tire service; steering head, fork and anti-dive unit overhaul.

Rear Suspension and Final Drive

Removal, inspection and installation procedures for spring- and air-shock designs.

Brakes

Complete mechanical and hydraulic overhaul procedures, including unified system.

Frame and Repainting

Replacement procedures for all removable parts, including Interstate equipment.

Sidecar Operation

Sidecar installation and adjustment; recommended modifications.

Index

Reference and cross-reference to all major sections of book.

Wiring Diagrams

Complete schematics for all models.



024185723813

CLYMER PUBLICATIONS